

EIKI

Owner's Manual

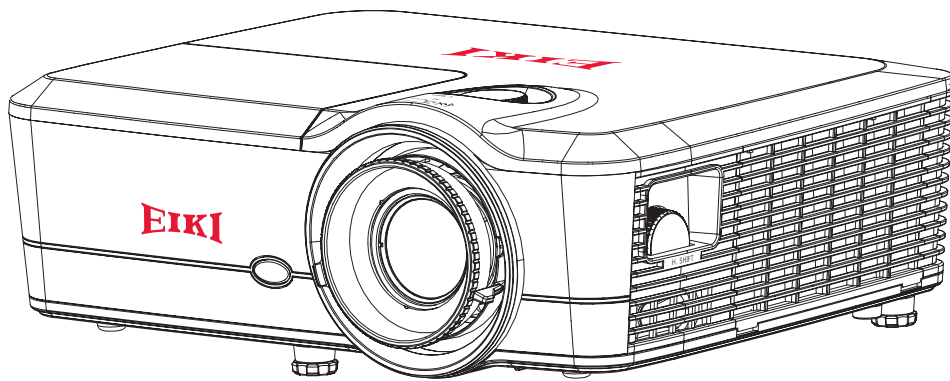

Multimedia Projector

Model EK-600U/ EK-601W

Features and Design

This Multimedia Projector is designed with the most advanced technology for portability, durability, and ease of use. This projector utilizes a high luminance and Eco friendly system, a palette of 1.07 billion colors, and digital light processing (DLP) technology.

Compact Design

This projector is designed compact in size and weight. It is easy to carry and installed anywhere you wish to use.

Simple Computer System Setting

The projector has the Multi-scan system to conform to almost all computer output signals quickly. Up to WUXGA (EK-600U) or WXGA (EK-601W) resolution can be accepted.

Useful Functions for Presentations

The digital zoom function allows you to focus on the crucial information during a presentation.

Lamp Control

Brightness of the projection lamp can be manually selected (Constant Power, Constant Luminance, or Eco Mode).

Background Color Function

The Background Color function allows you to specify the screen background ("Black", "Red", "Blue", "Green", or "White" screen) when no signal is available.

Multilanguage Menu Display

Operation menu is available in 22 languages; English, German, French, Italian, Spanish, Portuguese, Swedish, Dutch, Norsk/Dansk, Polish, Russian, Finnish, Hungarian, Czech, Arabic, Traditional Chinese, Simplified Chinese, Japanese, Korean, Thai, Turkish, and Indonesian.

Helpful Maintenance Functions

Lamp and filter maintenance functions provide for better and proper maintenance of the projector.

Security Function

The Security function helps you to ensure security of the projector.

LAN Network Function

This projector is loaded with the Wired LAN network function. You can operate and manage the projector via network. For details, refer to pages 45 - 52.

Auto Setup Function

This function enables auto input search and auto signal adjustment simply by pressing the Auto button on the keypad or remote control.

Power Management

The Power management function reduces power consumption and maintains the lamp life.

Note:

*The screen menu and pictures in the manual may slightly differ from the real product.
The manual is subject to change without prior notice.*

Copyright

This publication, including all photographs, illustrations and software, is protected under international copyright laws, with all rights reserved. Neither this manual, nor any of the material contained herein, may be reproduced without written consent of the author.

© Copyright 2016

Disclaimer

The information in this document is subject to change without notice. The manufacturer makes no representations or warranties with respect to the contents hereof and specifically disclaims any implied warranties of merchantability or fitness for any particular purpose. The manufacturer reserves the right to revise this publication and to make changes from time to time in the content hereof without obligation of the manufacturer to notify any person of such revision or changes.

Trademark Recognition

All other product names used in this manual are the properties of their respective owners and are acknowledged.

Important Safety Information

Important:

It is strongly recommended that you read this section carefully before using the projector. These safety and usage instructions will ensure that you enjoy many years of safe use of the projector. Keep this manual for future reference.

Symbols Used

Warning symbols are used on the unit and in this manual to alert you of hazardous situations. The following styles are used in this manual to alert you to important information.

Note:

Provides additional information on the topic at hand.

Important:

Provides additional information that should not be overlooked.

Caution:

Alerts you to situations that may damage the unit.

Warning:

Alerts you to situations that may damage the unit, create a hazardous environment, or cause personal injury.

Throughout this manual, component parts and items in the OSD menus are denoted in bold font as in this example:

“Push the **Menu** button on the remote control to open the **Main** menu.”

General Safety Information

- Do not open the unit case. Aside from the projection lamp, there are no user-serviceable parts in the unit. For servicing, contact qualified service personnel.
- Follow all warnings and cautions in this manual and on the unit case.
- The projection lamp is extremely bright by design. To avoid damage to eyes, do not look into the lens when the lamp is on.
- Do not place the unit on an unstable surface, cart, or stand.
- Avoid using the system near water, in direct sunlight, or near a heating device.
- Do not place heavy objects such as books or bags on the unit.

Safety Instructions

- Please read this manual completely before installing and operating the projector.
- The projector provides many convenient features and functions. Proper operation may enable you to fully utilize the features and keep it in good condition. Otherwise, it will not only shorten the service life of the unit, but also may cause malfunction, a fire, or other accidents.
- If your projector cannot work properly, please read this manual again, check the operating methods and cable connection, and try the solutions in the part of Troubleshooting. If the problem still exists, contact the dealer or the service center.
- The lamp of the projector is a wearing part. The luminance may decrease after a period of operation and be weaker than that of a new lamp. This is normal. Please strictly follow the steps in turning on the unit and turning off the unit to turn on/off the projector, and the requirements in maintaining and cleaning the projector to service and clean the projector regularly. Or the high temperature residual heat may not radiate, greatly shortening the service life of the projector and lamp, or even damaging them within a short period.

Caution:



ELECTRIC SHOCK DO NOT OPEN



Caution:

To reduce the risk of electric shock, do not remove cover (or back), no user serviceable parts inside except lamp replacement. Refer servicing to qualified service personnel.



This symbol indicates that dangerous voltage constituting a risk of electric shock is present within this unit.



This symbol indicates that there are important operating and maintenance instructions in the user's manual with this unit.

FOR EU USERS

The symbol mark and recycling systems described below apply to EU countries and do not apply to countries in other areas of the world.

Your product is designed and manufactured with high quality materials and components which can be recycled and/or reused.

The symbol mark means that electrical and electronic equipment, batteries and accumulators, at their end-of-life, should be disposed of separately from your household waste.

Note:

If a chemical symbol is printed beneath the symbol mark, this chemical symbol means that the battery or accumulator contains a heavy metal at a certain concentration. This will be indicated as follows: Hg: mercury, Cd: cadmium, Pb: lead In the European Union there are separate collection systems for used electrical and electronic equipment, batteries and accumulators.

Please, dispose of them correctly at your local community waste collection/recycling centre. Please help us to conserve the environment we live in!





Safety Precautions

Caution:

- *The projector must be grounded.*
 - *Do not expose the projector to raindrops or high humidity to avoid a fire or electric shock.*
- This projector produces intense light from the projection lens. Avoid staring directly into the lens, otherwise eye damage could be caused. Be especially careful that children do not stare directly into the beam.
 - Place the projector in a proper position. Otherwise it may result in fire hazard.
 - Leave an appropriate space from the top, sides, and back of the shell in order to ventilate and cool down the projector. The figures below indicate the minimum distance to be left. It must be satisfied if the projector is placed in sealed environment like a cabinet.

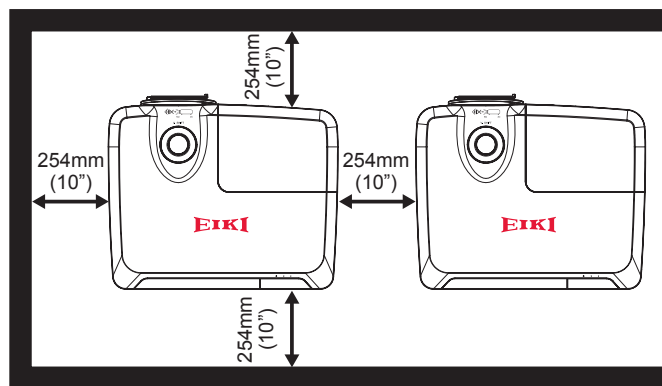

- Do not cover the vent of the projector. Poor radiation may shorten the service life or even cause dangers.
- Remove the AC power plug if the projector is not to be used for a long time.



Caution:

- *Do not set the projector in greasy, wet, or smoky conditions such as in a kitchen, to prevent a malfunction or accident. If the projector comes in contact with oil or chemicals, it may become deteriorated.*
- *Read and keep this manual for future reference.*
- *The mains plug/appliance coupler is used as disconnect device, the disconnect device shall remain readily operable.*

Safety Guide

- All the safety and operating instructions should be read before the product is operated.
 - Read all of the instructions given here and retain them for later use. Unplug this projector from AC power supply before cleaning. Do not use liquid or aerosol cleaners.
 - Use a damp cloth for cleaning.
 - Follow all warnings and instructions marked on the projector.
 - For added protection to the projector during a lightning storm, or when it is left unattended and unused for long periods of time, unplug it from the wall outlet. This will prevent damage due to lightning and power line surges.
 - Do not expose this unit to rain or use near water... for example, in a wet basement, near a swimming pool, etc...
 - Do not use attachments not recommended by the manufacturer as they may cause hazards.
 - Do not place this projector on an unstable cart, stand, or table. The projector may fall, causing serious injury to a child or an adult, and serious damage to the projector.
- 
- Use only with a cart or stand recommended by the manufacturer, or sold with the projector. Wall or shelf mounting should follow the manufacturer's instructions, and should use a mounting kit approved by the manufacturers.
 - An appliance and cart combination should be moved with care. Quick stops, excessive force, and uneven surfaces may cause the appliance and cart combination to overturn.
 - Slots and openings in the back and bottom of the cabinet are provided for ventilation, to ensure reliable operation of the equipment and to protect it from overheating.
 - The openings should never be covered with cloth or other materials, and the bottom opening should not be blocked by placing the projector on a bed, sofa, rug, or other similar surface. This projector should never be placed near or over a radiator or heat register.
 - This projector should not be placed in a build-in installation such as a book case unless proper ventilation is provided.
 - Never push objects of any kind into this projector through cabinet slots as they may touch dangerous voltage points or short out parts that could result in a fire or electric shock. Never spill liquid of any kind on the projector.
 - Do not install the projector near the ventilation duct of air-conditioning equipment.
 - This projector should be operated only from the type of power source indicated on the marking label.
 - If you are not sure of the type of power supplied, consult your authorized dealer or local power company.
 - Do not overload wall outlets and extension cords as this can result in fire or electric shock. Do not allow anything to rest on the power cord. Do not locate this projector where the cord may be damaged by persons walking on it.
 - Do not attempt to service this projector yourself as opening or removing the covers may expose you to dangerous voltage or other hazards. Refer all servicing to qualified service personnel.
 - Unplug this projector from wall outlet and refer servicing to qualified service personnel under the following conditions:
 - When the power cord or plug is damaged or frayed.
 - If liquid has been spilled into the projector.
 - If the projector has been exposed to rain or water.
 - If the projector does not operate normally by following the operating instructions. Adjust only those controls that are covered by the operating instructions as improper adjustment of other controls may result in damage and will often require extensive work by a qualified technician to restore the projector to normal operation.
 - If the projector has been dropped or the cabinet has been damaged.

- When the projector exhibits a distinct change in performance - this indicates a need for service.
- When replacement parts are required, be sure the service technician has used replacement parts specified by the manufacturer that have the same characteristics as the original part. Unauthorized substitutions may result in fire, electric shock, or injury to persons.
- Upon completion of any service or repairs to this projector, ask the service technician to perform routine safety checks to determine that the projector is in safe operating condition.

Information for users in the European Union

This is a device to project images onto a screen, etc., and is not intended for use as indoor lighting in a domestic environment.

Directive 2009/125/EC.

Note for customers in the US

Lamp(s) inside this product contain mercury and must be recycled or disposed of according to local state or federal laws.

Lamp(s) inside this product contain mercury and must be recycled or disposed of according to local state or federal laws.

Air circulation

Vents in the cabinet are provided for ventilation. To ensure reliable operation of the product and to protect it from overheating, these openings must not be blocked or covered.

**Caution:**

- *Hot air is exhausted from the exhaust vent. When using or installing the projector, the following precautions should be taken.*
- *Do not put any flammable objects, or spray can near the projector. Hot air is exhausted from the air vents.*
- *Keep the exhaust vent at least 1m away from any objects.*
- *Do not touch a peripheral part of the exhaust vent, especially screws and metallic part. This area will become hot while the projector is being used.*
- *Do not put anything on the projector. Objects put on the cabinet will not only get damaged but also may cause fire hazard by heat.*
- *Cooling fans are provided to cool down the projector.*
- *The fan's running speed is changed according to the temperature inside the projector.*

**Caution:****Contains mercury**

- *For more information on safe handling procedures, the measures to be taken in case of accidental breakage and safe disposal options visit: ec.gc.ca/mercure-mercury/.*
- *Dispose of or recycle in accordance with applicable laws.*

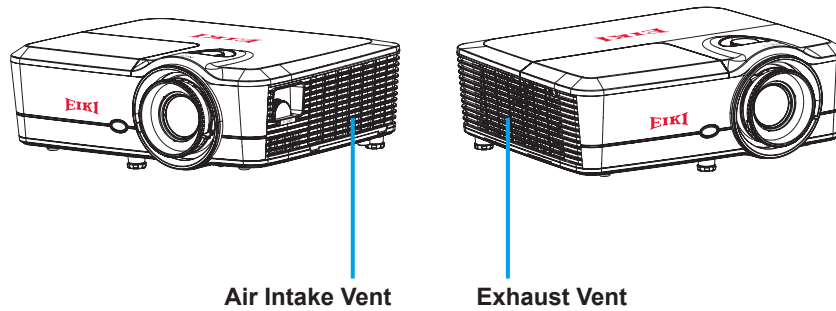

Moving the projector

When moving the projector, take care of the lens and retract the adjustable foot to prevent damage to the lens and cabinet.

Installing the projector properly

- Please set the projector on nearly-level.
- Be sure to install the projector properly. Improper installation may reduce the lamp lifetime and even cause a fire hazard.



Caution in ceiling installation the projector

- *Only qualified personal is authorized for ceiling installation.*
- *We are not responsible for the hurt and damage caused by ceiling bracket that purchased from unauthorized dealer even in warranty period.*
- *Remove the ceiling bracket immediately while not use.*
- *While installing, torque screwdriver is suggested, don't use electric or impact-type screwdriver.*
- *Please read the manual of bracket for details.*
- *The bracket is subject to change without notice.*

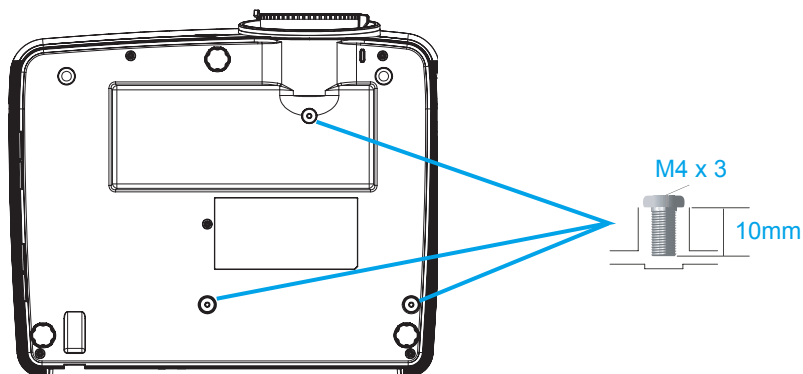

Caution in moving or transporting the projector

- *Do not drop or bump the projector, otherwise damages or malfunctions may result.*
- *When carrying the projector, use a suitable carrying case.*
- *Do not transport the projector by courier or any other transport service in an unsuitable transport case. This may cause damage to the projector. For information about transporting the projector by courier or any other transport service, consult your dealer.*
- *Do not put the projector in a case before it is cooled enough.*

Compliance

FCC Caution

Note: This equipment has been tested and found to comply with the limits for a Class A digital device, pursuant to Part 15 of the FCC Rules. These limits are designed to provide reasonable protection against harmful interference in a residential installation. This equipment generates, uses, and can radiate radio frequency energy, and if not installed and used in accordance with the instructions, may cause harmful interference to radio communications. However, there is no guarantee that interference will not occur in a particular installation. If this equipment does cause harmful interference to radio or television reception, which can be determined by turning the equipment off and on, the user is encouraged to try to correct the interference by one or more of the following measures:

- Reorient or relocate the receiving antenna.
- Increase the separation between the equipment and receiver.
- Connect the equipment into an outlet on a circuit different from that to which the receiver is connected.
- Consult the dealer or an experienced radio/TV technician for help.

Use of shielded cable is required to comply with class A limits in Subpart B of Part 15 of FCC Rules.

Do not make any changes or modifications to the equipment unless otherwise specified in the instructions. If such changes or modifications should be made, you could be required to stop operation of the equipment.

Model Number : EK-600U/EK-601W

Trade Name : EIKI

Responsible party : EIKI International, Inc.

Address : 30251 Esperanza Rancho Santa Margarita CA 92688-2132

Telephone No. : 800-242-3454 (949-457-0200)

AC Power Cord Requirement

The AC Power Cord supplied with this projector meets the requirement for use in the country you purchased it.

AC Power Cord for the United States and Canada:

AC Power Cord used in the United States and Canada is listed by the Underwriters Laboratories (UL) and certified by the Canadian Standard Association (CSA).

AC Power Cord has a grounding-type AC line plug. This is a safety feature to be sure that the plug will fit into the power outlet. Do not try to defeat this safety feature. Should you be unable to insert the plug into the outlet, contact your electrician.

Warning:

A plug with bared flexible cord is hazardous if engaged in a live socket outlet.

The Wires in this mains lead are coloured in accordance with the following code:

- Green-and-yellow Earth
- Blue Neutral
- Brown Live

As the colours of the wires in the mains lead of this apparatus may not correspond with the coloured markings identifying the terminals in your plug proceed as follows:

- The wire which is coloured green-and-yellow must be connected to the terminal in the plug which is marked by the letter E or by the safety earth symbol or coloured green or green-and-yellow.
- The wire which is coloured blue must be connected to the terminal which is marked with the letter N or coloured black.
- The wire which is coloured brown must be connected to the terminal which is marked with the letter L or coloured red.

Warning:

This apparatus must be earthed.

Note:

The socket-outlet should be installed near the equipment and easily accessible.

Contents

GETTING STARTED	1
PACKING CHECKLIST.....	1
VIEWS OF PROJECTOR PARTS	2
Front-right View	2
Left View	3
Rear View	4
Built-in Keypad.....	5
Bottom View.....	6
REMOTE CONTROL PARTS	7
REMOTE CONTROL OPERATING RANGE	9
PROJECTOR AND REMOTE CONTROL BUTTONS	9
INSERTING THE REMOTE CONTROL BATTERIES	10
SETUP AND OPERATION	11
STARTING AND SHUTTING DOWN THE PROJECTOR	11
Turn the Projector On	11
Turn the Projector Off	12
ADJUSTING THE PROJECTOR LEVEL.....	13
ADJUSTING THE ZOOM, FOCUS, AND KEYSTONE	14
PROJECTION SIZE	15
Projection Size v.s Throw Distance.....	15
ON-SCREEN DISPLAY (OSD) MENU SETTINGS	17
OSD MENU CONTROLS.....	17
Navigating the OSD	17
SETTING THE OSD LANGUAGE	18
OSD MENU OVERVIEW	19
PICTURE MENU	27
Advanced Menu.....	28
Color Matching Menu.....	29
Signal Menu (VGA Input).....	30
Signal Menu (Video Input)	31
OUTPUT MENU	32
Image Warping Menu.....	33
3D Display Menu	34
SETUP MENU	35
Pin Menu.....	36
Audio Settings Menu.....	37

Advanced Menu	38
HDBaseT Control Menu	38
Communications Menu	39
OPTIONS MENU	40
Remote Settings Menu	41
Advanced Menu	42
Lamp Settings Menu	43
Optional Filter Settings Menu	44
CONTROL YOUR PROJECTOR USING WEB BROWSER	45
Wired LAN Terminal functionalities	45
Supported External Devices	45
LAN_RJ45	45
RS232 by Telnet Function	50
MAINTENANCE AND SECURITY	53
REPLACING THE PROJECTION LAMP	53
Resetting the Lamp	55
REPLACING THE FILTER (FILTER IS OPTIONAL.)	56
CLEANING THE PROJECTOR	57
Cleaning the Lens	57
Cleaning the Case	58
USING THE KENSINGTON® LOCK	58
TROUBLESHOOTING	59
COMMON PROBLEMS AND SOLUTIONS	59
TIPS FOR TROUBLESHOOTING	59
LED ERROR MESSAGES	60
IMAGE PROBLEMS	61
LAMP PROBLEMS	61
REMOTE CONTROL PROBLEMS	62
HAVING THE PROJECTOR SERVICED	62
HDMI Q & A	63
SPECIFICATIONS	64
SPECIFICATIONS	64
COMPATIBLE RESOLUTION	65
PROJECTOR DIMENSIONS	68

REGULATORY COMPLIANCE 69
FCC WARNING 69
CANADA 69
SAFETY CERTIFICATIONS 69

GETTING STARTED

Packing Checklist

Carefully unpack the projector and check that the following items are included:

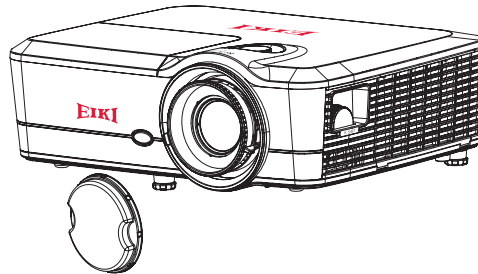

DLP PROJECTOR

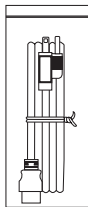

AC POWER CORD

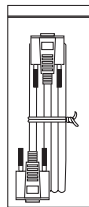

VGA CABLE

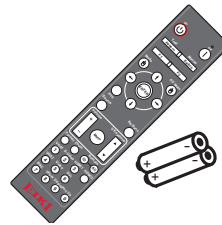

REMOTE CONTROL
(WITH TWO AAA
BATTERIES)

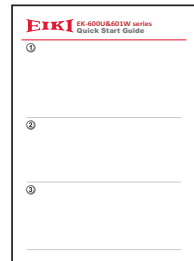

QUICK START GUIDE

Contact your dealer immediately if any items are missing, appear damaged, or if the unit does not work. It is recommended that you keep the original packing material should you ever need to return the equipment for warranty service.

Note:

- Avoid using the projector in dusty environments.

Views of Projector Parts

Front-right View

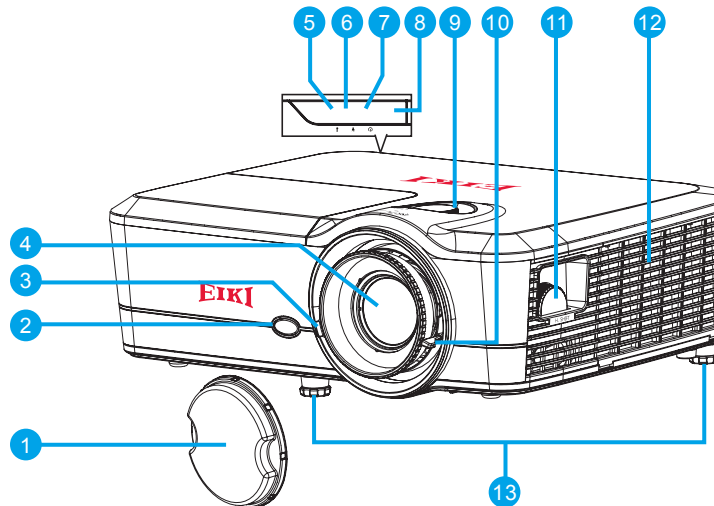

ITEM	LABEL	DESCRIPTION	SEE PAGE
1	Lens Cap	Provides protection for projector lens.	-
2	Front IR Sensor	Receives signals from the IR remote. Keep the signal path to the sensor unobstructed for uninterrupted communication with the projector.	9
3	Focus	Adjust focus.	14
4	Projection Lens	Allows automated zoom.	-
5	Temp LED	Indicate the temperature status.	60
6	Lamp LED	Indicate the lamp status.	60
7	On/Standby LED	Indicate the power status.	60
8	Top IR Sensor	Receives signals from the IR remote. Keep the signal path to the sensor unobstructed for uninterrupted communication with the projector.	9
9	Lens Shift (Vertical)	Adjust the lens vertical offset setting.	16
10	Zoom	Adjust zoom.	14
11	Lens Shift (Horizontal)	Adjust the lens horizontal offset setting.	16
12	Cooling Air Vents (Intake)	Keep these vents unobstructed to prevent the projector from overheating.	-
13	Adjustable Feet	Raise or lower the feet to level the projector.	13

Important:

Ventilation openings on the projector allow for good air circulation, which keeps the projector lamp cool. Do not obstruct any of the ventilation openings.

Left View

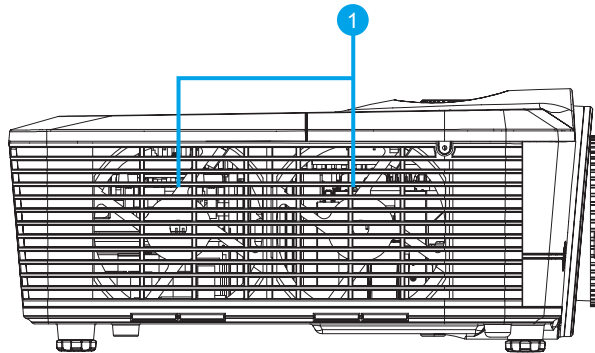

ITEM	LABEL	DESCRIPTION	SEE PAGE
1	Cooling Air Vents (Exhaust)	Keep these vents unobstructed to prevent the projector from overheating.	-

Important:

Ventilation openings on the projector allow for good air circulation, which keeps the projector lamp cool. Do not obstruct any of the ventilation openings.

Rear View

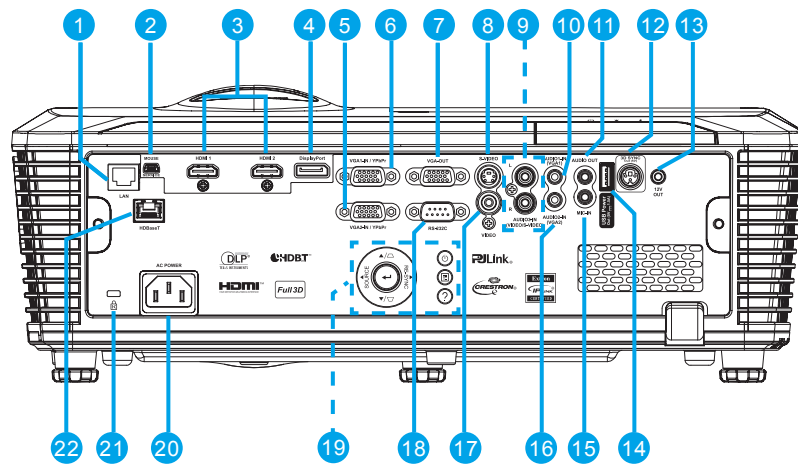

ITEM	LABEL	DESCRIPTION	SEE PAGE
1	RJ45	Connect a LAN cable from Ethernet.	45
2	USB-B Mini	Mouse connection.	-
3	HDMI	Connect the HDMI cable to a HDMI device.	-
4	DisplayPort	Connect the displayport cable to a display.	66-67
5	VGA2-IN/YPbPr	Connect the VGA cable from a computer or component device.	-
6	VGA1-IN/YPbPr	Connect the VGA cable from a computer or component device.	-
7	VGA-OUT	Connect the VGA cable to a display.	-
8	S-Video	Connect the S-video cable to a video device.	-
9	Audio3-IN (Video/S-Video)	Connect the audio cable from an audio-video device.	-
10	Audio1-IN(VGA1)	Connect the audio cable from an audio-video device.	-
11	Audio OUT	Connect the audio cable to an audio device.	-
12	3D Sync OUT (5V)	Connect the 3D IR glasses transmitter. (Note: For Specific 3D IR glasses only)	-
13	12V OUT	Connect a 12V DC connector.	-
14	USB Power Out (5V---1.5A)	Connect a USB dongle.	-
15	MIC-IN	Connect the microphone.	-
16	Audio2-IN(VGA2)	Connect the audio cable from an audio-video device.	-
17	VIDEO	Connect the video cable to a video device.	-
18	RS-232C	Connect RS-232 serial port cable for remote control.	-
19	Built-in Keypad	Control the projector.	5
20	AC Input	Connect to the supplied power adapter.	11
21	Kensington Lock	Use to secure the projector to countertops, tables, etc.	58
22	HDBaseT	Connect a RJ45 Cat5/Cat6 Ethernet cable to input uncompressed high-definition video control signals.	-

Built-in Keypad

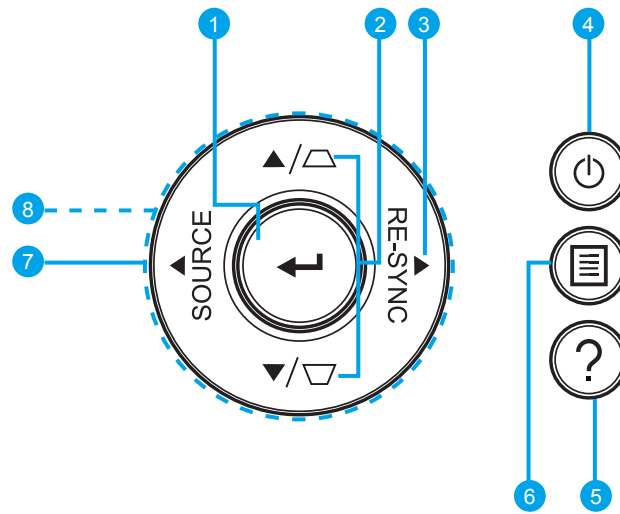

ITEM	LABEL	DESCRIPTION	SEE PAGE
1	Enter	<ul style="list-style-type: none"> Select a highlighted menu item. Change or accept a value. 	17
2	Keystone Correction	Adjust the image distortion caused by tilting the projector.	15-16
3	Re-Sync	Automatically synchronize the projector to the input source.	-
4	Power	Turn the projector on or off.	11-12
5	Information	Display the projector information.	-
6	Menu	OSD MENU Setting.	17
7	Source	Select an input signal.	-
8	Arrow keys	<ul style="list-style-type: none"> Adjust a setting UP/DOWN or LEFT/RIGHT. Navigate within a menu. 	17

Bottom View

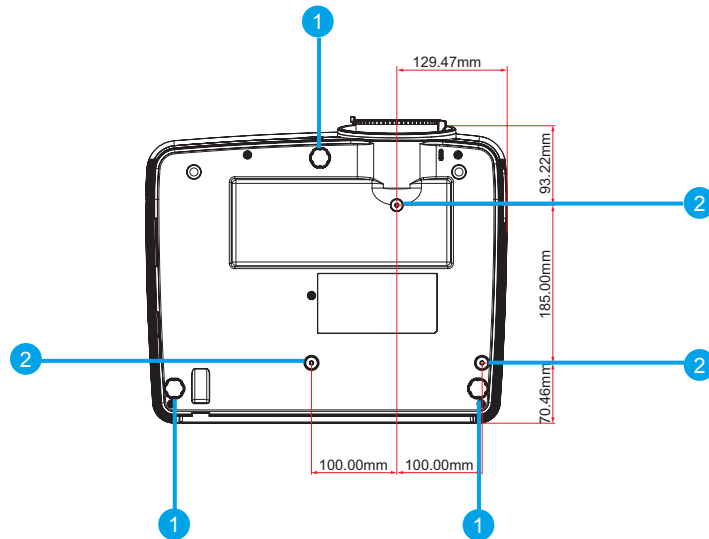

ITEM	LABEL	DESCRIPTION	SEE PAGE
1	Adjustable Feet	Raise or lower the feet to level the projector.	13
2	Ceiling support holes	Contact your dealer for information on mounting the projector on a ceiling.	viii-ix

Note:

- When installing, ensure that you use only UL Listed ceiling mounts.
- For ceiling installations, use approved mounting hardware and M4 screws with a maximum screw depth of 10 mm (0.39 inch).
- The construction of the ceiling mount must be of a suitable shape and strength. The ceiling mount load capacity must exceed the weight of the installed equipment, and as an additional precaution be capable of withstanding three times the weight of the equipment (not less than 20 kg) over a period of 60 seconds.

Remote Control Parts

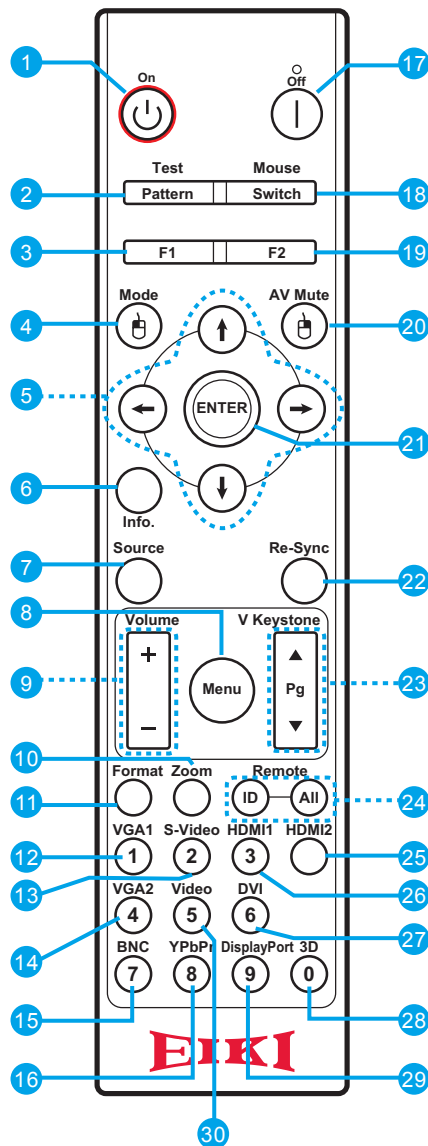

Important:

1. Avoid using the projector with bright fluorescent lighting turned on. Certain high-frequency fluorescent lights can disrupt remote control operation.
2. Be sure nothing obstructs the path between the remote control and the projector. If the path between the remote control and the projector is obstructed, you can bounce the signal off certain reflective surfaces such as projector screens.
3. The buttons and keys on the projector have the same functions as the corresponding buttons on the remote control. This owner's manual describes the functions based on the remote control.

Note:

Complies with FDA performance standards for laser products except for deviations pursuant to Laser Notice No. 50, dated June 24, 2007.

ITEM	LABEL	DESCRIPTION	SEE PAGE
1	Power on	Turn projector ON.	11
2	Pattern	Display a test pattern.	-
3	Function button (F1) (Assignable)	Programmable function button.	-
4	Mode/Mouse left click	<ul style="list-style-type: none"> • Display mode menu on/off. • Use as mouse left click when mouse is switched on. 	-
5	Arrow Keys	<ul style="list-style-type: none"> • Adjust a setting UP/DOWN or LEFT/RIGHT. • Navigate within a menu. 	17
6	Info.	Display source image information.	-
7	Source	Press "Source" to select an input signal.	-
8	Menu	Display menus.	17
9	Volume - / +	Press to increase or decrease the volume.	-
10	Zoom	Adjust zoom to achieve a desired image size.	14
11	Format (Aspect Ratio)	Press to choose the projector format.	-
12	VGA1/1	<ul style="list-style-type: none"> • Select the VGA1 input source. • Use as numeric keypad number "1". 	-
13	S-Video/2	<ul style="list-style-type: none"> • Select the S-Video input source. • Use as numeric keypad number "2". 	-
14	VGA2/4	<ul style="list-style-type: none"> • Select the VGA2 input source. • Use as numeric keypad number "4". 	-
15	BNC/7	<ul style="list-style-type: none"> • Select the BNC input source. • Use as numeric keypad number "7". 	-
16	YPbPr/8	<ul style="list-style-type: none"> • Select the Component input source. • Use as numeric keypad number "8". 	-
17	OFF	Turn projector OFF.	12
18	Mouse	Press to switch the USB mouse on/off.	-
19	Function button (F2) (Assignable)	Programmable function button.	-
20	AV mute/Mouse right click	<ul style="list-style-type: none"> • Press to turn off/on projector built-in speaker. • Use as mouse left click when mouse is switched on. 	-
21	Enter	<ul style="list-style-type: none"> • Select a highlighted menu item. • Change or accept a value. 	17
22	Re-sync	Automatically synchronize the projector to the input source.	-
23	V keystone/Page Up/Down	<ul style="list-style-type: none"> • Adjust the vertical keystone. • Use to navigate page up or page down. 	14
24	Remote ID/Remote all	<ul style="list-style-type: none"> • Press until Power LED is flashing then press 01~99 to set the particular remote code. • Press to set remote code to all. 	-
25	HDMI2	Press to choose HDMI source.	-
26	HDMI1/3	<ul style="list-style-type: none"> • Press to choose HDMI source. • Use as numeric keypad number "3". 	-

ITEM	LABEL	DESCRIPTION	SEE PAGE
27	DVI/6	<ul style="list-style-type: none"> Select the DVI input source. Use as numeric keypad number "6". 	-
28	3D/0	<ul style="list-style-type: none"> Select the 3D input source. Use as numeric keypad number "0". 	-
29	DisplayPort/9	<ul style="list-style-type: none"> Select the Display port input source. Use as numeric keypad number "9". 	66-67
30	Video/5	<ul style="list-style-type: none"> Select the Composite Video input source. Use as numeric keypad number "5". 	-

**Caution:**

Use of controls, adjustments or performance of procedures other than those specified herein may result in hazardous laser light exposure.

Note:

Some keys may have no function for models that do not support these features.

Remote Control Operating Range

The remote control uses infrared transmission to control the projector. It is not necessary to point the remote directly at the projector. Provided you are not holding the remote perpendicular to the front of the projector, the remote will function well within a radius of about 7 meters (23 feet) and 15 degrees above and below the projector level or 10 degrees on the left side or right side of the projector. If the projector does not respond to the remote control, move a little closer.

Projector and Remote Control Buttons

The projector can be operated using the remote control or the buttons on the rear of the projector. All operations can be carried out with the remote control; however, the buttons on the projector are limited in use.

Inserting the Remote Control Batteries

1. Remove the battery compartment cover as shown in the illustration.

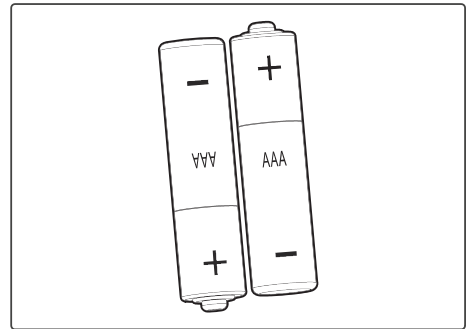

2. Insert the batteries with correct polarity (+/-) as shown inside the battery compartment.

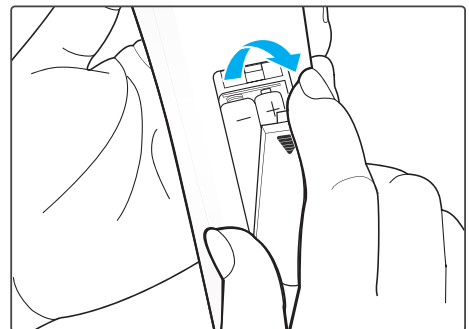

3. Replace the cover.

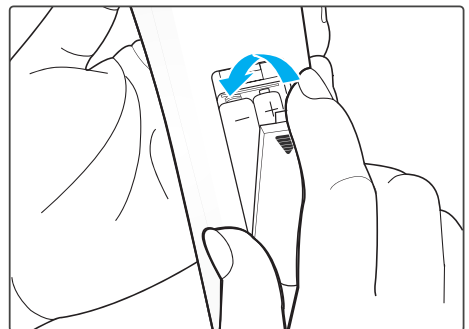

Caution:

- Only use AAA batteries (Alkaline batteries are recommended).
- Dispose of used batteries according to local ordinance regulations.
- Remove the batteries when not using the projector for prolonged periods.

Starting and Shutting down the Projector

Turn the Projector On

1. Connect the power cord to the projector. Then connect the other end to a wall outlet.
The Power button on the built in keypad is illuminated.



2. Remove the lens cap.

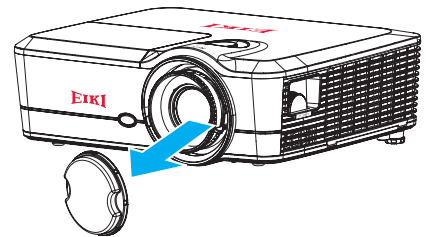

3. Turn on the connected devices.

4. Turn on the projector by pressing “⏻” on the remote control or on the built-in keypad. The Status LED is flashing Blue with a long blink.

The projector splash screen displays and connected devices are detected.



Note:

The first time the projector is turned on you will be asked to select the preferred language, projection orientation and a few other settings.

5. If more than one input device is connected, press the **Source** key on the remote control to select an input source (VGA1, VGA2, Video, S-Video, HDMI1, HDMI2, DisplayPort, or HDBaseT).
6. The projector detects the source you selected and displays the image.

Turn the Projector Off

1. Press “⏻” on the built-in keypad or press “⏻” on the remote control to turn off the projector. A warning message will appear on the displayed image.

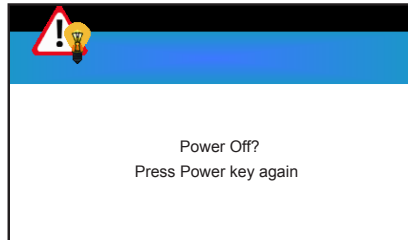

2. Press “⏻” on the built-in keypad or press “⏻” on the remote control again to confirm your selection. If you do not press “⏻” or “⏻” again, the warning message will disappear after 15 seconds.

Caution:

- *The cooling fans will continue to operate for about 10 seconds for the cooling cycle and the On/Standby LED will flash Blue. When the On/Standby LED turns solid red the projector has entered standby mode. If you wish to turn the projector back on, you must wait until the cooling cycle has finished and the projector has entered standby mode. When the projector is in standby mode simply press “⏻” button again to turn on the projector.*

3. Disconnect the power lead from the electrical outlet and the projector.

Adjusting the Projector Level

Take note of the following when setting up the projector:

- The projector table or stand should be level and sturdy.
- Position the projector so that it is perpendicular to the screen.
- Ensure the cables are in a safe location. You could trip over them.

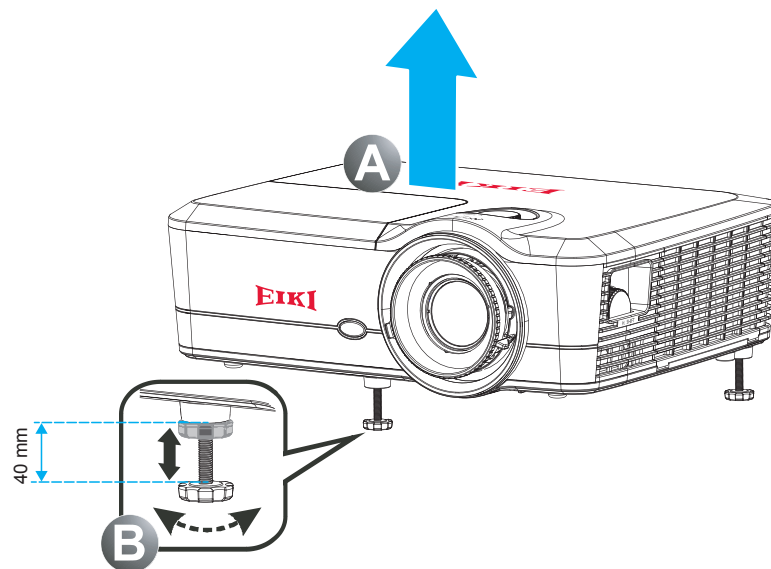

- 1.** To raise the level of the projector, lift the projector **A**.
- 2.** Locate the adjustable foot you wish to modify on the underside of the projector.
- 3.** Rotate the adjustable foot clockwise to raise the projector or counter-clockwise to lower it. Repeat with the remaining feet as necessary **B**.

Adjusting the Zoom, Focus, and Keystone

1. Use the **Zoom** lever to resize the projected image and screen size **B**.
2. Use the **Focus** lever to sharpen the projected image **A**.

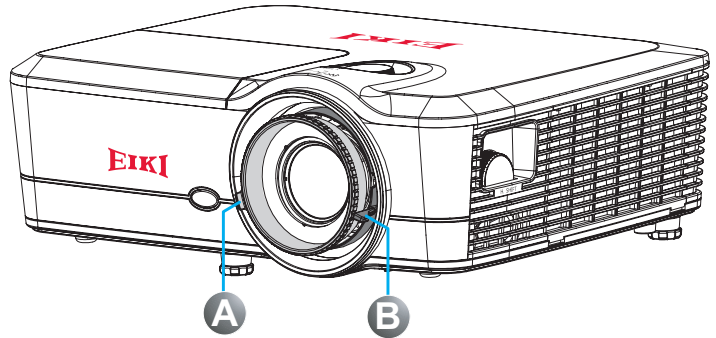

3. Use the **V Keystone** button to adjust the keystone vertically and make a squarer image **A**.

Note:

Horizontal keystone can only be adjusted manually.

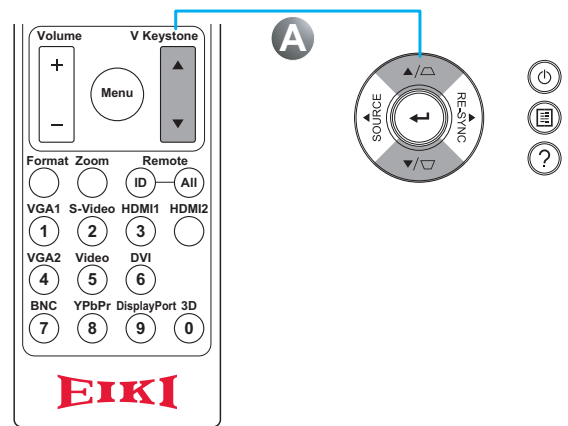

Projection Size

Projection Size v.s Throw Distance

EK-600U

DIAGONAL LENGTH(INCH) SIZE OF 16:10 SCREEN	SCREEN SIZE W x H		PROJECTION DISTANCE (D)		OFFSET (Hd)
	(M)		(M)		(CM)
	WIDTH	HEIGHT	WIDE	TELE	MAX
30	0.65	0.40	/	1.4	8.1
40	0.86	0.54	1.0	1.8	10.8
50	1.08	0.67	1.3	2.3	13.5
60	1.29	0.81	1.5	2.8	16.2
70	1.51	0.94	1.8	3.2	18.9
80	1.72	1.08	2.1	3.7	21.5
90	1.94	1.21	2.3	4.1	24.2
100	2.15	1.35	2.6	4.6	26.9
120	2.58	1.62	3.1	5.5	32.3
150	3.23	2.02	3.9	6.9	40.4
180	3.88	2.42	4.6	8.3	48.5
200	4.31	2.69	5.2	9.2	53.9
250	5.38	3.37	6.4	/	67.3
300	6.46	4.04	7.7	/	80.8

EK-601W

DIAGONAL LENGTH(INCH) SIZE OF 16:10 SCREEN	SCREEN SIZE W x H		PROJECTION DISTANCE (D)		OFFSET (Hd)	
	(M)		(M)		(CM)	
	WIDTH	HEIGHT	WIDE	TELE	MAX	MIN
30	0.65	0.40	/	1.4	10.1	2.0
40	0.86	0.54	1.1	1.9	13.5	2.7
50	1.08	0.67	1.4	2.4	16.8	3.4
60	1.29	0.81	1.6	2.9	20.2	4.0
70	1.51	0.94	1.9	3.4	23.6	4.7
80	1.72	1.08	2.2	3.9	26.9	5.4
90	1.94	1.21	2.4	4.3	30.3	6.1
100	2.15	1.35	2.7	4.8	33.7	6.7
120	2.58	1.62	3.2	5.8	40.4	8.1
150	3.23	2.02	4.1	7.2	50.5	10.1
180	3.88	2.42	4.9	8.7	60.6	12.1
200	4.31	2.69	5.4	9.6	67.3	13.5
250	5.38	3.37	6.8	12.0	84.1	16.8
300	6.46	4.04	8.1	/	101.0	20.2

Note:

- Vertical Lens Shift values are always calculated from the Center of Projection Lens. Therefore the distance 5.2 cm (2.05 inch) from the Base to the Center of Projection Lens needs to be added to each Vertical Lens Shift value.
- Zoom ratio is 1.8x.

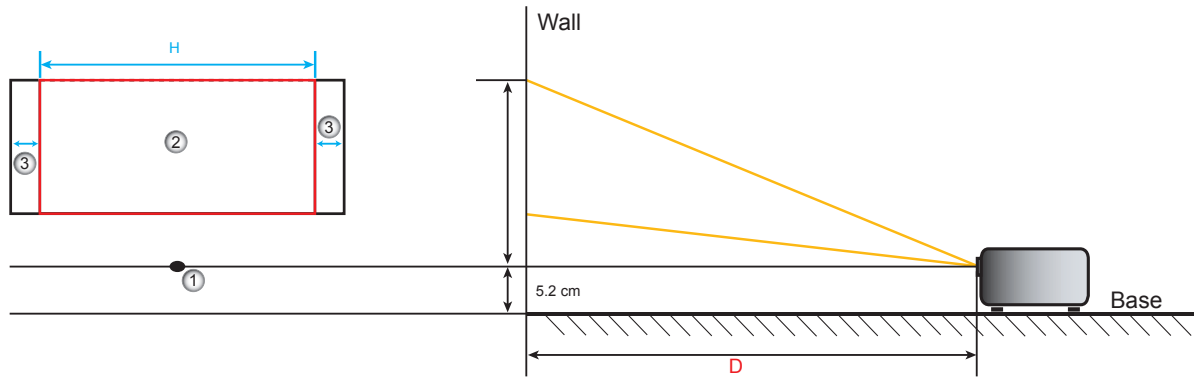

1. Center of projection lens.
2. Projection image while lens shift at the highest position.
3. Horizontal shift range: 10% H.

ON-SCREEN DISPLAY (OSD) MENU SETTINGS

OSD Menu Controls

The projector has an OSD that lets you make image adjustments and change various settings.

Navigating the OSD

You can use the remote control cursor buttons or the projector keypad to navigate and make changes to the OSD.

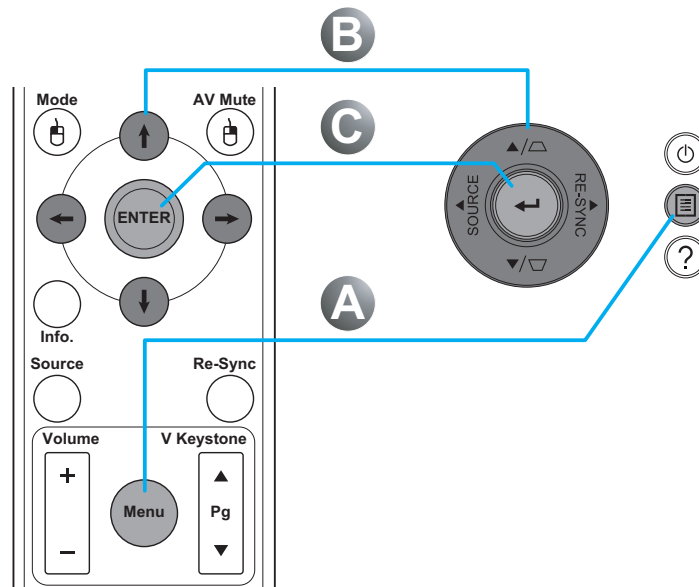

1. To enter the OSD, press the **Menu** button **A**.
2. Use the arrow keys (**▲▼◀▶**) to navigate within the menu and adjust a setting up or down **B**.
3. Press the **Enter** button to enter the submenu or confirm the selection/setting **C**.
4. Press the **Menu** button again to return to the previous menu or exit menus if at top level **A**.

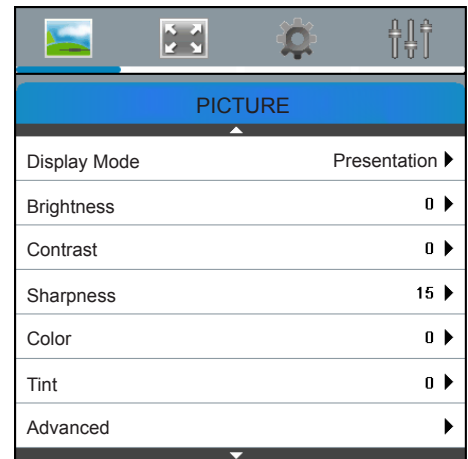

Caution:

Depending on the video source, not all items in the OSD are available. Items that are not available cannot be accessed and are grayed out.

Setting the OSD Language

Set the OSD language to your preference before continuing.

1. Press the **Menu** button.

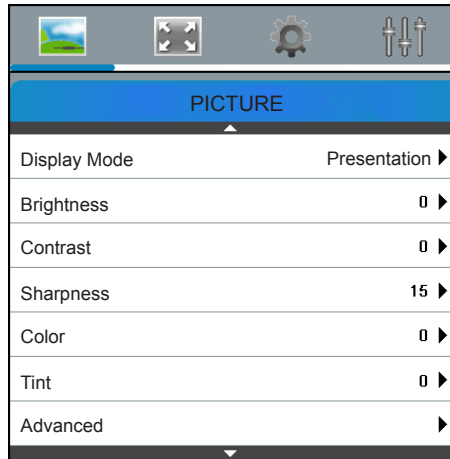

2. Use the arrow keys (▲▼) to select **SETUP** and press the **Enter** button to enter the **SETUP** menu.



3. Use the arrow keys (▲▼) to select **Language** and press the **Enter** button to enter its submenu.
4. Use the arrow keys (▲▼◀▶) to select the desired language and press the **Enter** button to enter its confirm.
5. Press the **Menu** button several times to exit the menu.

Language			
English	Nederlands	Čeština	Türkçe
Deutsch	Norsk/Dansk	عربي	한국어
Français	Polski	繁體中文	Svenska
Italiano	Русский	简体中文	ไทย
Español	Suomi	日本語	Indonesian
Português	Magyar		Exit

OSD Menu Overview

Use the following illustration to quickly find a setting or determine the range for a setting.

MAIN MENU	SUB MENU / SETTINGS				DEFAULT		
PICTURE	Display Mode	Presentation			Presentation (Each mode can adjust and save in each mode).		
		Bright					
		Movie					
		sRGB					
		Blackboard					
		DICOM SIM.					
		User					
		3D					
	Brightness	-50 ~ 50			By source set		
	Contrast	-50 ~ 50					
	Sharpness	1 ~ 15					
	Color	-50 ~ 50					
	Tint	-50 ~ 50					
	Advanced	Noise Reduction	0 ~ 10			Off	
			BrilliantColor™	1 ~ 10			
			DynamicBlack™	On / Off			
		Gamma	Film			By source set	
			Graphics				
			1.8				
			2.0				
			2.2				
			2.6				
			Blackboard				
		DICOM					
		Color Temperature	Warm			By source set	
			Standard				
			Cool				
Cold							
Color Space		Not HDMI Input:			Auto		
		Auto					
		RGB					
		YUV					
	HDMI Input:						
	Auto						
	RGB(0~255)						
	RGB(16~235)						
YUV							

MAIN MENU	SUB MENU / SETTINGS		DEFAULT				
PICTURE	Advanced	Color Settings	Red Gain	-50 ~ 50	By source set		
			Green Gain	-50 ~ 50			
			Blue Gain	-50 ~ 50			
			Red Offset	-50 ~ 50			
			Green Offset	-50 ~ 50			
			Blue Offset	-50 ~ 50			
			Reset	Yes / No			
			Exit				
		Color Matching	Red	Hue	-50 ~ 50	By source set	
				Saturation			
				Gain			
				Exit			
				Green	Hue		-50 ~ 50
					Saturation		
					Gain		
					Exit		
				Blue	Hue		-50 ~ 50
					Saturation		
					Gain		
					Exit		
			Cyan	Hue	-50 ~ 50		
				Saturation			
				Gain			
				Exit			
			Magenta	Hue	-50 ~ 50		
				Saturation			
				Gain			
Exit							
Yellow	Hue		-50 ~ 50				
	Saturation						
	Gain						
	Exit						
White	Red		-50 ~ 50				
	Green						
	Blue						
	Exit						
Reset	Yes						
	No						
Exit							

MAIN MENU	SUB MENU / SETTINGS			DEFAULT	
PICTURE	Advanced	Signal (VGA input)	Auto Image	On	On
				Off	
			Phase	0 ~ 31	
			Frequency	-10 ~ 10	
			Horz Position	-10 ~ 10	
			Vert Position	-10 ~ 10	
			Exit		
		Signal (Video input)	White Level	0 ~ 31	16
			Black Level	-5 ~ 5	0
			IRE	0	0 (NTSC only)
				7.5	
		Exit			
	Reset	Yes			
No					
OUTPUT	Aspect Ratio	4:3		Auto	
		16:9 or 16:10			
		LBX			
		Native			
		Auto			
	Zoom	-5 ~ 25		0	
	Edge Mask	0 ~ 10		By source set	
	Image Shift	H	-100 ~ 100	0	
		V	-100 ~ 100		
	Image Warping	H. Keystone	-30 ~ 30	0	
			V. Keystone		-30 ~ 30
		Auto V. Keystone	On	Off	
			Off		
		Four Corners	Top-Left		
			Top-Right		
			Bottom-Left		
	Bottom-Right				
Reset	Yes				
	No				
	Exit				

MAIN MENU	SUB MENU / SETTINGS				DEFAULT
OUTPUT	3D Display	3D Mode	DLP-Link		Off
			VESA 3D		
			Off		
		3D→2D	3D		3D
			L		
			R		
		3D Enable	Auto		Auto
			Side by Side		
			Top and Bottom		
			Frame Sequential		
3D Invert	On		Off		
	Off				
	Exit				
SETUP	Language	English			
		Deutsch			
		Français			
		Italiano			
		Español			
		Português			
		Svenska			
		Nederlands			
		Norsk/Dansk			
		Polski			
		Русский			
		Suomi			
		Magyar			
		Čeština			
		عربي			
		繁體中文			
		簡體中文			
		日本語			
		한국어			
		ไทย			
	Türkçe				
	Indonesian				
	Projection	Front		Front	
		Rear			
		Front-Ceiling			
		Rear-Ceiling			
	Screen Type	16:10		16:10	
16:9					

MAIN MENU	SUB MENU / SETTINGS				DEFAULT	
SETUP	Menu Location	Top-Left			Center	
		Top-Right				
		Center				
		Bottom-Left				
		Bottom-Right				
	Pin	Pin Protect	On			Off
			Off			
		Security Timer	Month			
			Day			
			Hour			
		Change PIN				1234
	Exit					
	Projector ID	00 ~ 99				00
	Audio Settings	Internal Speaker	On			On
			Off			
		Mute	On			Off
			Off			
	Audio Settings	Volume	Audio	0 ~ 10		5
			Mic	0 ~ 10		
		Audio Input	Default			Default: VGA1 -> Audio 1 (mini jack) VGA2 -> Audio 2 (mini jack) Video, S-Video -> Audio 3 (L/R)
			Audio1			
			Audio2			
			Audio3			
		Audio Out(Standby)	On			Off
			Off			
	Exit					
	Advanced	Logo	Default			Default
			User			
			Neutral			
		Logo Capture				
		Closed Captioning	Off			Off
			CC1			
	Exit					
	HDBaseT Control	Ethernet	On			Off
			Off			
		RS232	On			
			Off			
		HDBaseT Mode	Auto			Auto
			HDBaseT			
	Exit					

MAIN MENU	SUB MENU / SETTINGS				DEFAULT	
SETUP	Communication	LAN	Network Status	Connect / Disconnect	Read-Only	
			MAC Address	xx : xx : xx : xx : xx : xx		
			DHCP	On / Off	Off	
			IP Address	192.168.0.100	192.168.0.100	
			Subnet Mask	255.255.255.0	255.255.255.0	
			Default Gateway	192.168.0.254	192.168.0.254	
			DNS	192.168.0.1	192.168.0.1	
			Exit			
		Control Settings	Crestron	On		On (port: 41794)
				Off		
			Extron	On		On (port: 2023)
				Off		
			PJLink	On		On (port: 4352)
				Off		
	AMX Device Discovery		On		On (port: 9131)	
			Off			
	Telnet	On		On (port: 23)		
		Off				
	HTTP	On		On (port: 80)		
		Off				
	Exit					
Reset						
Exit						
Exit						
OPTIONS	Input Source	VGA1				
		VGA2				
		Video				
		S-Video				
		HDMI1				
		HDMI2				
		Displayport				
		HDBaseT				
		Exit				
	Source Lock	On			Off	
		Off				
	High Altitude	On			Off	
		Off				
	Information Hide	On			Off (Warning message and Power off message are not hidden).	
		Off				

MAIN MENU	SUB MENU / SETTINGS				DEFAULT
OPTIONS	Keypad Lock	On			Off
		Off			
	Display Mode Lock	On			Off
		Off			
	Test Pattern	None			None
		Grid			
		White Pattern			
	Background Color	Black			Blue
		Red			
		Blue			
		Green			
		White			
	Wall Color	Off			Off
		Light Yellow			
		Light Green			
		Light Blue			
		Pink			
		Gray			
	Remote Settings	User1	HDMI2		Test Pattern
			DP		
			VGA2		
			S-Video		
			Test Pattern		
			Zoom		
			Info.		
		HDBaseT			
		User2	HDMI2		Zoom
			DP		
			VGA2		
			S-Video		
			Test Pattern		
			Zoom		
Info.					
HDBaseT					
IR Function	All		All		
	Front				
	Top				
	Off				
Projector Address	00 ~ 99		00		
	Exit				
12V Trigger	On		Off		
	Off				
Beep	On		On		
	Off				

MAIN MENU	SUB MENU / SETTINGS				DEFAULT	
OPTIONS	Advanced	Direct Power On	On		Off	
			Off			
		Auto Power Off (min)	0-180 (one step: 5 mins)		20	
		Sleep Timer (min)	0-990 (one step: 10 mins)		0	
			Repeat		Off	
		Quick Resume	On	(EK601W only)		Off
			Off			
	Standby Power Mode	Normal		Eco.		
		Eco.				
	Exit					
	Lamp Settings	Lamp Hours			Read only	
		Lamp Reminder	On		On	
			Off			
		Lamp Mode	Bright		Bright	
			Eco			
			Power			
		Power	365W		280W	
			350W			
			330W			
			310W			
	300W					
	Lamp Hours Reset	Yes				
		No				
	Exit					
	Filter	Filter Usage Hours			Read only	
		Optional Filter Installed	Yes		No	
			No			
		Filter Reminder	Off		500 hr	
			300 hr			
			500 hr			
			800 hr			
			1000 hr			
		Filter Reset	Yes			
No						
Exit						
Information						
Reset	Yes					
	No					
Exit						

Picture Menu

Press the **Menu** button to open the OSD menu. Press the arrow keys (▲▼) to select **PICTURE** and press the **Enter** button to enter the **PICTURE** menu. Press the arrow keys (▲▼) to select the menu option and press the **Enter** button to enter its submenu. Press the arrow keys (▲▼◀▶) to select or adjust the desired settings and press the **Enter** button to confirm.

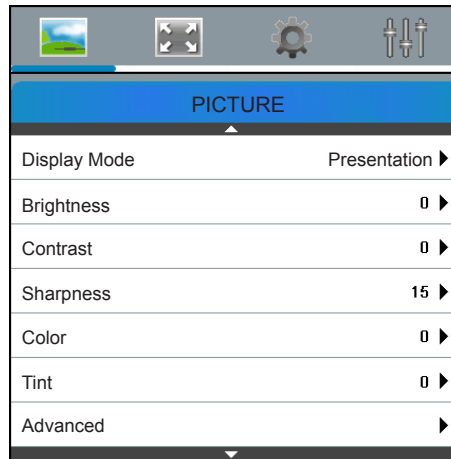

ITEM	DESCRIPTION
Display Mode	Optimize the projector for displaying images under certain conditions, such as Presentation, Bright, Movie, sRGB, Blackboard, DICOM SIM., user-definable preset, and 3D.
Brightness	Adjust the intensity of the image.
Contrast	Adjust the degree of difference between the lightest and darkest parts of the picture and change the amount of black and white in the image.
Sharpness	Select the edge clarity of the image.
Color	Adjust a video image from black and white to fully saturated color. The color setting applies to video sources only.
Tint	Adjust the red-green color balance in the image of video images. The tint setting applies to video sources only.
Advanced	Configure the advanced image settings. See "Advanced Menu" on page 28.

Advanced Menu

Press the **Menu** button to open the OSD menu. Press the arrow keys (▲▼) to select **PICTURE** and press the **Enter** button to enter the **PICTURE** menu. Press the arrow keys (▲▼) to select **Advanced** and press the **Enter** button to enter the **Advanced** menu. Press the arrow keys (▲▼) to select the menu option and press the **Enter** button to enter its submenu. Press the arrow keys (▲▼◀▶) to select or adjust the desired settings and press the **Enter** button to confirm.

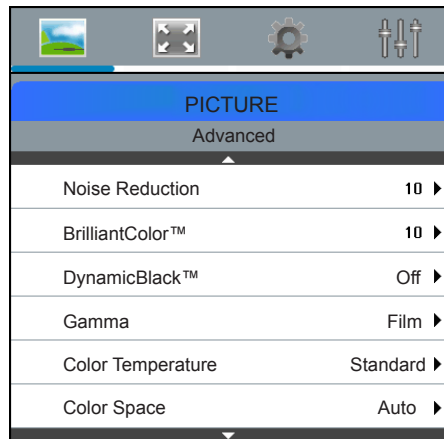

ITEM	DESCRIPTION
Noise Reduction	The motion Adaptive Noise Reduction reduces the amount of visible noise interlaced signals.
BrilliantColor™	Produce an expanded on-screen color spectrum that delivers enhanced color saturation for bright, true-to-life images
DynamicBlack™	Enable or disable the dynamic black function. Enable this function raises the contrast ratio dynamically.
Gamma	Select the appropriate gamma from Film, Graphics, 1.8, 2.0, 2.2, 2.6, Blackboard and DICOM.
Color Temperature	Change the intensity of the colors. Select a listed relative warmth value.
Color Space	Select a color space that has been specifically tuned for the input signal. Use only for analog signals and certain digital sources.
Color Settings	Adjust the gain of the red, green, or blue channel of the image. It will affect the black and white. Adjust the offset of the red, green, or blue channel of the image. It will affect the black and white. Reset RGB gain/offset to return the factory default settings for color adjustments.
Color Matching	Configure the color matching parameters. See “Color Matching Menu” on page 29.
Signal (VGA Input)	Configure the signal paramters for VGA input. See “Signal Menu (VGA Input)” on page 30.
Signal (Video Input)	Configure the signal paramters for Video input. See “Signal Menu (Video Input)” on page 31.

Color Matching Menu

Press the **Menu** button to open the OSD menu. Press the arrow keys (▲▼) to select **PICTURE** and press the **Enter** button to enter the **PICTURE** menu. Press the arrow keys (▲▼) to select **Advanced** and press the **Enter** button to enter the **Advanced** menu. Press the arrow keys (▲▼) to select **Color Matching** and press the **Enter** button to enter the **Color Matching** menu. Press the arrow keys (▲▼) to select the menu option and press the **Enter** button to enter its submenu. Press the arrow keys (▲▼◀▶) to select or adjust the desired settings and press the **Enter** button to confirm.

Color Matching	
Red	Cyan
Green	Magenta
Blue	Yellow
White	Reset
Exit	

You may require a unique color gamut (range) for a single projector or application, or you may need to precisely match colors across multiple adjacent displays. Use Color Matching by Meter Adjustment or by Manual Adjustment to define the precise hue of each primary color component (red, green, blue and white).

The x/y coordinates for each color define its location on the standard CIE chromaticity graph. Changing either or both of these numbers will change the hue of the color, and modify the range of possible colors. For example, changing the x/y coordinates for red may move the color closer to orange or closer to violet, which will in turn affect all displayed colors having a red component. Adjust the slide bars or enter new specific coordinates as desired to define or change the color gamuts needed for your environment and applications.

Enable the selected method (Meter or Manual Adjustment)- this will automatically disable the other method. For both methods, if Auto Test Pattern is enabled, the solid colored test pattern will be displayed according to the menu item on which you are positioned.

- **Meter Adjustment**

1. Using a color meter, enter the current x and y co-ordinates of Red, Green, Blue and White for the projector image into the Measured Data menu. This is the reference point for the projector. The default values in the menu are based on the average for all projectors.
2. After measuring the values for all the projectors to be matched, calculate the target values.
3. Enter the target values for x, y and gain for each color into the Target Data menu.

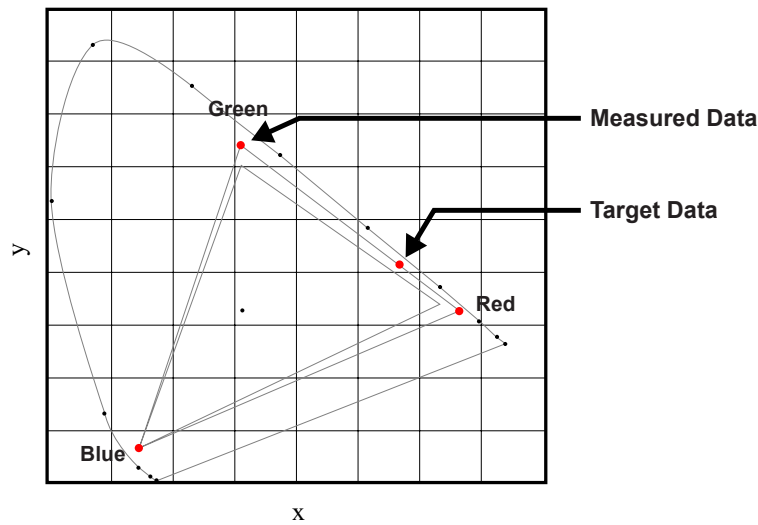

• **Manual Adjustment**

1. Adjust color slide bars and judge image color by eye or meter. A user-defined color “adjustment” can be applied.
2. Use this submenu if you do not have specific color coordinates in mind and will judge color performance by eye or meter. As for Meter Adjustment, each color control actually defines new x/y coordinates for that color and changes its hue. The main colors (red part of red, green part of green and blue part of blue) adjust the intensity of that color component, while the modifying colors (e.g. green part of red and blue part of red) modify the x and y value and change the hue of that color. At the same time the main colors also are used to control the color of the white point.

Signal Menu (VGA Input)

Press the **Menu** button to open the OSD menu. Press the arrow keys (▲▼) to select **PICTURE** and press the **Enter** button to enter the **PICTURE** menu. Press the arrow keys (▲▼) to select **Advanced** and press the **Enter** button to enter the **Advanced** menu. Press the arrow keys (▲▼) to select **Signal** and press the **Enter** button to enter the **Signal** menu. Press the arrow keys (▲▼) to select the menu option and press the **Enter** button to enter its submenu. Press the arrow keys (▲▼◀▶) to select or adjust the desired settings and press the **Enter** button to confirm.

PICTURE	
Advanced: Signal	
Auto Image	On ▶
Phase	16 ▶
Frequency	0 ▶
Horz Position	0 ▶
Vert Position	0 ▶
Exit	

ITEM	DESCRIPTION
Auto Image	Force the projector to reacquire and lock to the input signal. This is useful when signal quality is marginal.
Phase	Analog signals only. Adjust pixel phase when the image still shows shimmer or noise after pixel tracking is optimized. Pixel phase can adjust the phase of the pixel-sampling clock relative to the incoming signal.
Frequency	Analog signals only. Steady flickering or several soft vertical stripes or bands across the entire image indicates poor frequency. Proper frequency ensures that the image quality is consistent across the screen, the aspect ratio is maintained, and that the pixel phase can be optimized.
Horz Position	Move the image right or left within the area of available pixels.
Vert Position	Move the image up or down within the area of available pixels.

Signal Menu (Video Input)

Press the **Menu** button to open the OSD menu. Press the arrow keys (▲▼) to select **PICTURE** and press the **Enter** button to enter the **PICTURE** menu. Press the arrow keys (▲▼) to select **Advanced** and press the **Enter** button to enter the **Advanced** menu. Press the arrow keys (▲▼) to select **Signal** and press the **Enter** button to enter the **Signal** menu. Press the arrow keys (▲▼) to select the menu option and press the **Enter** button to enter its submenu. Press the arrow keys (▲▼◀▶) to select or adjust the desired settings and press the **Enter** button to confirm.

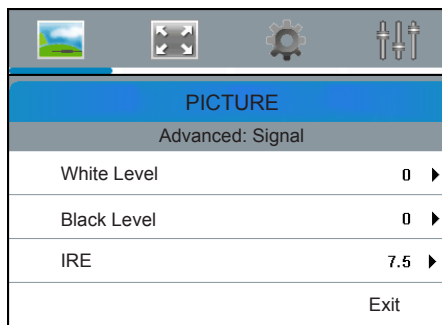

ITEM	DESCRIPTION
White Level	Allow user adjust White Level when inputting Video signals.
Black Level	Allow user adjust Black Level when inputting Video signals.
IRE	Allow user adjust IRE value when inputting Video signals. <div style="border: 1px solid black; padding: 5px; margin-top: 5px;"> <p>Note: IRE is only available with NTSC video format.</p> <ul style="list-style-type: none"> • Press the ◀ to decrease the amount of color in the image. • Press the ▶ to increase the amount of color in the image. </div>

Output Menu

Press the **Menu** button to open the OSD menu. Press the arrow keys (▲▼) to select **OUTPUT** and press the **Enter** button to enter the **OUTPUT** menu. Press the arrow keys (▲▼) to select the menu option and press the **Enter** button to enter its submenu. Press the arrow keys (▲▼◀▶) to select or adjust the desired settings and press the **Enter** button to confirm.





ITEM	DESCRIPTION
Aspect Ratio	Display an image with the detected size, or resize the image by maximizing either the height, width or both, or resize to the maximum size possible while keeping the original aspect ratio.
Zoom	<ul style="list-style-type: none"> Press the ◀ to reduce the size of an image. Press the ▶ to magnify an image on the projection screen.
Edge Mask	Edge mask the image to remove video encoding noise on the edge of video source.
Image Shift	<p>Press ▶ into the next menu as below and then use ▲ or ▼ or ◀ or ▶ to select item.</p> <div data-bbox="555 1323 801 1480" style="border: 1px solid black; padding: 5px; margin: 10px 0;"> <p style="text-align: center;">Image Shift</p> <div style="text-align: center;">  </div> <p style="text-align: center;">H : 0 V : 0</p> </div> <ul style="list-style-type: none"> H: Press the ◀ ▶ to shift the projected image position horizontally. V: Press the ▲ ▼ to shift the projected image position vertically.
Image Warping	Configure the image warping settings. See “Image Warping Menu” on page 33.
3D Display	Configure the 3D display settings. See “3D Display Menu” on page 34.

Image Warping Menu

Press the **Menu** button to open the OSD menu. Press the arrow keys (▲▼) to select **OUTPUT** and press the **Enter** button to enter the **OUTPUT** menu. Press the arrow keys (▲▼) to select **Image Warping** and press the **Enter** button to enter the **Image Warping** menu. Press the arrow keys (▲▼) to select the menu option and press the **Enter** button to enter its submenu. Press the arrow keys (▲▼◀▶) to select or adjust the desired settings and press the **Enter** button to confirm.

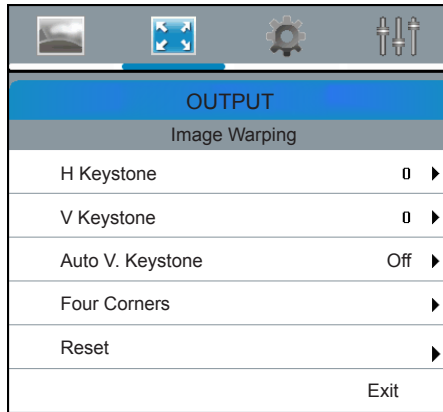

ITEM	DESCRIPTION
H Keystone	Adjust the keystone horizontally and make a squarer image. Horizontal keystone is used to correct a keystone image shape in which the left and right borders of the image are unequal in length. This is intended for use with horizontally on-axis applications. 
V Keystone	Adjust the keystone vertically and make a squarer image. Vertical keystone is used to correct a keystone image shape in which the top and bottom are slanted to one of the sides. This is intended when for use with vertically on-axis applications. 
Auto V Keystone	Automatically corrects vertical keystone error.
Four Corners	Compensate for image distortion by adjusting one corner at a time. To use this function, do the following: <ol style="list-style-type: none"> 1. Use "Four Corners" menu to choose one corner and press "Enter" to confirm. 2. Use ▲▼◀▶ to move the angle and press "Enter" to confirm.
Reset	Reset Image Warping menu items to their factory defaults.

3D Display Menu

Press the **Menu** button to open the OSD menu. Press the arrow keys (▲▼) to select **OUTPUT** and press the **Enter** button to enter the **OUTPUT** menu. Press the arrow keys (▲▼) to select **3D Display** and press the **Enter** button to enter the **3D Display** menu. Press the arrow keys (▲▼) to select the menu option and press the **Enter** button to enter its submenu. Press the arrow keys (▲▼◀▶) to select or adjust the desired settings and press the **Enter** button to confirm.

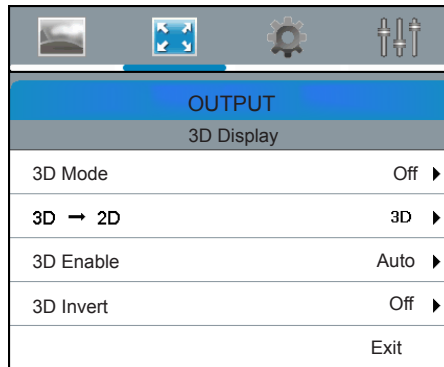

ITEM	DESCRIPTION
3D Mode	<ul style="list-style-type: none"> DLP-Link: Select "DLP-Link" to use optimized settings for DLP Link 3D Glasses. VESA 3D: Select "VESA 3D" to use optimized setting for VESA 3D Glasses. Off: DLP-Link.
3D → 2D	<ul style="list-style-type: none"> 3D: Display 3D signal. L (Left): Display the left frame of 3D content. R (Right): Display the right frame of 3D content.
3D Enable	Set 3D format. Supports Mandatory 3D formats and frame sequential 3D@120Hz.
3D Invert	Invert 3D sync signal for the application of using single projector.

Setup Menu

Press the **Menu** button to open the OSD menu. Press the arrow keys (▲▼) to select **SETUP** and press the **Enter** button to enter the **SETUP** menu. Press the arrow keys (▲▼) to select the menu option and press the **Enter** button to enter its submenu. Press the arrow keys (▲▼◀▶) to select or adjust the desired settings and press the **Enter** button to confirm.

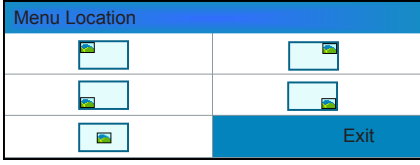

ITEM	DESCRIPTION
Language	This item allows you to select an available language for the OSD display.
Projection	Select the projection mode, depending upon how the projector is mounted. 
Screen Type	Choose the screen type from 16:10 or 16:9.
Menu Location	Choose the menu location on the display screen. 
Pin	Configure the pin settings. See “Pin Menu” on page 36.
Projector ID	ID definition can be set up by menu (range 0-99), and allow user control an individual projector by RS232.
Audio Settings	Configure the audio settings. See “Audio Settings Menu” on page 37.
Advanced	Configure the advanced settings. See “Advanced Menu” on page 38.
HDBaseT Control	Configure the HDBaseT control settings. See “HDBaseT Control Menu” on page 38.
Communications	Configure the communications settings. See “Communications Menu” on page 39.

Pin Menu

Press the **Menu** button to open the OSD menu. Press the arrow keys (▲▼) to select **SETUP** and press the **Enter** button to enter the **SETUP** menu. Press the arrow keys (▲▼) to select **Pin** and press the **Enter** button to enter the **Pin** menu. Press the arrow keys (▲▼) to select the menu option and press the **Enter** button to enter its submenu. Press the arrow keys (▲▼◀▶) to select or adjust the desired settings and press the **Enter** button to confirm.

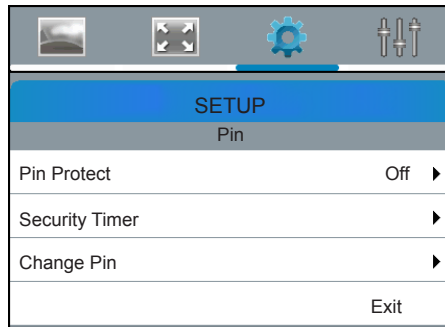

ITEM	DESCRIPTION										
Pin Protect	The Pin (personal identification number) feature allows you to password protect your projector. Once you enable the Pin feature, you must enter the Pin before you can project an image. (Pin Default : 12345)										
Security Timer	Can be select the time (Month/Day/Hour) function to set the number of hours the projector can be used. Once this time has elapsed you will be requested to enter your password again. <div data-bbox="555 1133 976 1341" data-label="Image"> <table border="1"> <thead> <tr> <th colspan="2">Security Timer</th> </tr> </thead> <tbody> <tr> <td>Month</td> <td>6</td> </tr> <tr> <td>Day</td> <td>15</td> </tr> <tr> <td>Hour</td> <td>12</td> </tr> <tr> <td colspan="2">Exit</td> </tr> </tbody> </table> </div>	Security Timer		Month	6	Day	15	Hour	12	Exit	
Security Timer											
Month	6										
Day	15										
Hour	12										
Exit											
Change Pin	Change the Pin.										

Audio Settings Menu

Press the **Menu** button to open the OSD menu. Press the arrow keys (▲▼) to select **SETUP** and press the **Enter** button to enter the **SETUP** menu. Press the arrow keys (▲▼) to select **Audio Settings** and press the **Enter** button to enter the **Audio Settings** menu. Press the arrow keys (▲▼) to select the menu option and press the **Enter** button to enter its submenu. Press the arrow keys (▲▼◀▶) to select or adjust the desired settings and press the **Enter** button to confirm.

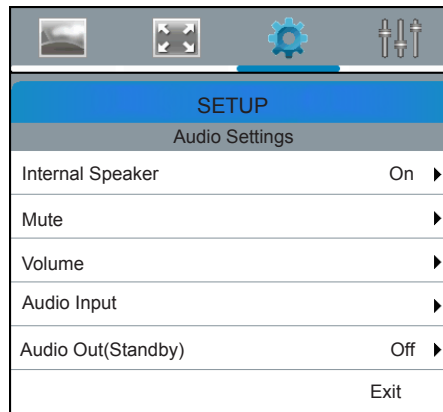

ITEM	DESCRIPTION
Internal Speaker	Choose the "On" or "Off" to turn on or off the internal speaker.
Mute	Mute or unmute the volume: <ul style="list-style-type: none"> Choose the "On" to turn mute on. Choose the "Off" to turn mute off. <div style="border: 1px solid black; padding: 5px; margin-top: 10px;"> <p>Note: "Mute" function affects both internal and external speaker volume.</p> </div>
Volume	Configure volume parameters. <ul style="list-style-type: none"> Audio: Adjust the volume level. Mic: Adjust the microphone volume level.
Audio Input	The default audio settings are on the back panel of the projector. Use this option to reassign any of the Audio Inputs (1, 2, or 3) to the current image source. Each Audio input can be assigned to more than one video source. <ul style="list-style-type: none"> Default: VGA 1 -> Audio 1; VGA 2 -> Audio 2; Video, S-Video -> Audio 3 (L/R). Audio 1 / 2: Mini jack connection. Audio 3: L/R.
Audio Out(Standby)	Choose the "On" or "Off" to turn on or off the audio out.

Advanced Menu

Press the **Menu** button to open the OSD menu. Press the arrow keys (▲▼) to select **SETUP** and press the **Enter** button to enter the **SETUP** menu. Press the arrow keys (▲▼) to select **Advanced** and press the **Enter** button to enter the **Advanced** menu. Press the arrow keys (▲▼) to select the menu option and press the **Enter** button to enter its submenu. Press the arrow keys (▲▼◀▶) to select or adjust the desired settings and press the **Enter** button to confirm.

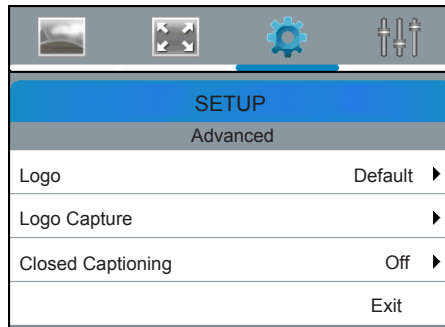

ITEM	DESCRIPTION
Logo	Use this function to set the desired startup screen. If changes are made they will take effect the next time the projector is powered on. <ul style="list-style-type: none"> • Default: The default startup screen. • User: Create a customized startup screen using the Logo Capture function. • Neutral: Logo is not displayed on startup screen.
Logo Capture	Press ▶ to capture an image of the picture currently displayed on screen.
Closed Capturing	Closed Captioning is a text version of the program sound or other information displayed on the screen. If the input signal contains closed captions, you can turn on the feature and watch the channels. Press ◀ or ▶ to select Off, CC1, or CC2.

HDBaseT Control Menu

Press the **Menu** button to open the OSD menu. Press the arrow keys (▲▼) to select **SETUP** and press the **Enter** button to enter the **SETUP** menu. Press the arrow keys (▲▼) to select **HDBaseT Control** and press the **Enter** button to enter the **HDBaseT Control** menu. Press the arrow keys (▲▼) to select the menu option and press the **Enter** button to enter its submenu. Press the arrow keys (▲▼◀▶) to select or adjust the desired settings and press the **Enter** button to confirm.

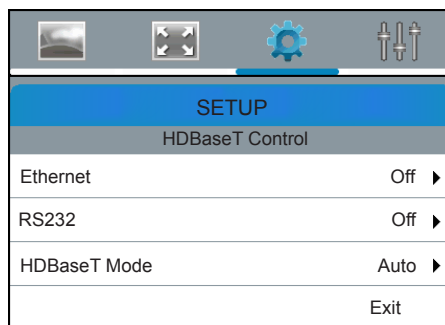

ITEM	DESCRIPTION
Ethernet	Enable or disable the Ethernet feature.
RS232	Enable or disable the RS232 feature.
HDBaseT Mode	Set the HDBaseT mode setting: <ul style="list-style-type: none"> • Auto: The projector will automatically switch to the HDBaseT mode when it detects a signal from the HDBaseT port. • HDBaseT: The projector is switched to the HDBaseT mode.

Communications Menu

Press the **Menu** button to open the OSD menu. Press the arrow keys (▲▼) to select **SETUP** and press the **Enter** button to enter the **SETUP** menu. Press the arrow keys (▲▼) to select **Communications** and press the **Enter** button to enter the **Communications** menu. Press the arrow keys (▲▼) to select the menu option and press the **Enter** button to enter its submenu. Press the arrow keys (▲▼◀▶) to select or adjust the desired settings and press the **Enter** button to confirm.

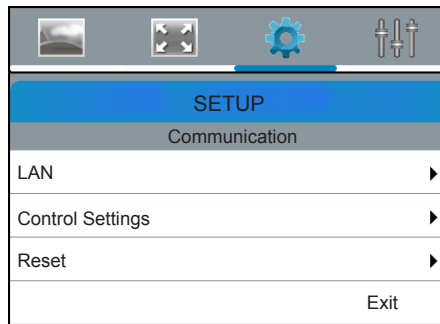

ITEM	DESCRIPTION
LAN	Configure the local area network (LAN) settings. <ul style="list-style-type: none"> • Network Status: Display the network connection status (read-only). • MAC Address: Display the network MAC Address value. • DHCP: Turn the DHCP ON/OFF. • IP Address: Assign Network IP Address. • Subnet Mask: Assign Network Subnet Mask. • Default Gateway: Assign Network Default Gateway. • DNS: Display DNS number.
Control Settings	<ul style="list-style-type: none"> • Crestron: Use this function to select the network function (port: 41794). For more information, please visit http://www.crestron.com and www.crestron.com/getroomview. • Extron: Use this function to select the network function (port: 2023). • PJLink: Use this function to select the network function (port: 4352). • AMX Device Discovery: Use this function to select the network function (port: 1023). • Telnet: Use this function to select the network function (port: 23). • HTTP: Use this function to select the network function (port: 80).
Reset	Reset the Communication menu items to their factory defaults.

Options Menu

Press the **Menu** button to open the OSD menu. Press the arrow keys (▲▼) to select **OPTIONS** and press the **Enter** button to enter the **OPTIONS** menu. Press the arrow keys (▲▼) to select the menu option and press the **Enter** button to enter its submenu. Press the arrow keys (▲▼◀▶) to select or adjust the desired settings and press the **Enter** button to confirm.

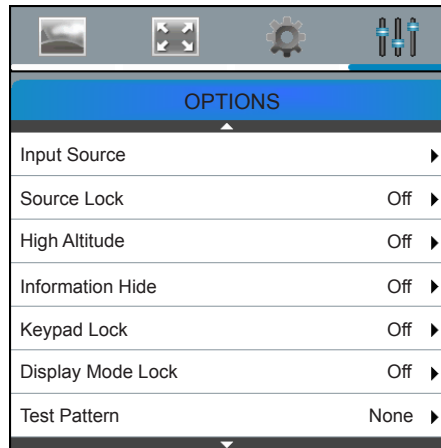

ITEM	DESCRIPTION
Input Source	Use this option to enable/disable input sources. Press ► to enter the submenu and select which sources you require. Press “Enter” to finalize the selection. The projector will only search for inputs that are enabled.
Source Lock	<ul style="list-style-type: none"> On: The projector will only search current input connection. Off: The projector will search for other signals if the current input signal is lost.
High Altitude	Set high altitude mode On/Off. When On, the fan will operate at high speed to ensure sufficient air flow for high altitudes.
Information Hide	<ul style="list-style-type: none"> On: Choose “On” to hide the info message. Off: Choose “Off” to show the “searching” message.
Keypad Lock	When the keypad lock function is “On”, the Keypad will be locked however, the projector can be operated by the remote control. By selecting “Off”, you will be able to reuse the Keypad.
Display Mode Lock	<ul style="list-style-type: none"> On: Lock adjusting display mode settings. Off: Unlock adjusting display mode settings.
Test Pattern	Display a test pattern. There are Grid, White Pattern and None.
Background Color	Use this feature to display a “Black”, “Red”, “Blue”, “Green” or “White” screen when no signal is available.
Wall Color	Use this function to obtain an optimized screen image according to the wall color. The available options: “Off”, “Light Yellow”, “Light Green”, “Light Blue”, “Pink”, and “Gray”.
Remote Settings	Configure the remote settings. “Remote Settings Menu” on page 41.

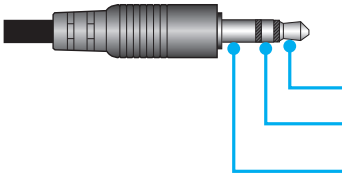
ITEM	DESCRIPTION
12V Trigger	<ul style="list-style-type: none"> On: Choose "On" to enable the trigger. Off: Choose "Off" to disable the trigger. 
Beep	<ul style="list-style-type: none"> Off: No beep sound is audible when a key is pressed or in an error event. On: Beep sound is audible when a key is pressed or in an error event.
Advanced	Configure the advanced settings. See "Advanced Menu" on page 42.
Lamp Settings	Configure the lamp settings. See "Lamp Settings Menu" on page 43.
Optional Filter Settings	Configure the optional filter settings. See "Optional Filter Settings Menu" on page 44.
Information	Display the projector information for source, resolution, and software version on the screen.

Remote Settings Menu

Press the **Menu** button to open the OSD menu. Press the arrow keys (▲▼) to select **OPTIONS** and press the **Enter** button to enter the **OPTIONS** menu. Press the arrow keys (▲▼) to select **Remote Settings** and press the **Enter** button to enter the **Remote Settings** menu. Press the arrow keys (▲▼) to select the menu option and press the **Enter** button to enter its submenu. Press the arrow keys (▲▼◀▶) to select or adjust the desired settings and press the **Enter** button to confirm.

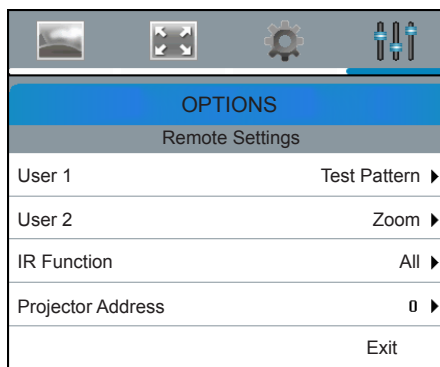

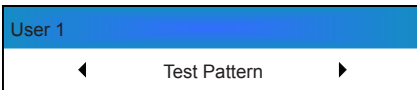
ITEM	DESCRIPTION
User 1	<p>The default value is "Test Pattern".</p> <ul style="list-style-type: none"> Press ▶ into the next menu and then use ◀ or ▶ to select "HDMI2", "DP", "VGA2", "S-Video", "Test Pattern", "Zoom", or "Info.", "HDBaseT" item. 

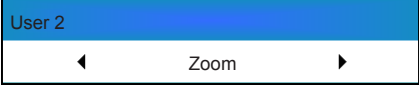
ITEM	DESCRIPTION
User 2	<p>The default value is "Zoom".</p> <ul style="list-style-type: none"> Press ► into the next menu and then use ◀ or ▶ to select "HDMI2", "DP", "VGA2", "S-Video", "Test Pattern", "Zoom", or "Info.", "HDBaseT" item. 
IR Function	<ul style="list-style-type: none"> All: Choose "All", the projector can be operated by the remote control from front or top IR receiver. Front: Choose "Front", the projector can be operated by the remote control from front IR receiver. Top: Choose "Top", the projector can be operated by the remote control from top IR receiver. Off: Choose "Off", the projector can't be operated by the remote control from front or top IR receiver. By selecting "Off", you will be able to use the Keypad keys. <p>Note: "Front" and "Top" cannot be selected in standby mode.</p>
Projector Address	Set the projector address. The projector will respond to IR remotes set either at the same address as the projector or to IR remotes set to address 0.

Advanced Menu

Press the **Menu** button to open the OSD menu. Press the arrow keys (▲▼) to select **OPTIONS** and press the **Enter** button to enter the **OPTIONS** menu. Press the arrow keys (▲▼) to select **Advanced** and press the **Enter** button to enter the **Advanced** menu. Press the arrow keys (▲▼) to select the menu option and press the **Enter** button to enter its submenu. Press the arrow keys (▲▼◀▶) to select or adjust the desired settings and press the **Enter** button to confirm.

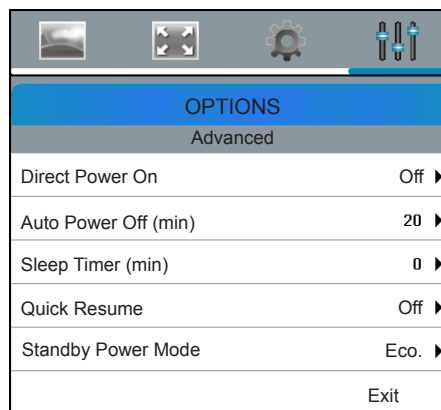

ITEM	DESCRIPTION
Direct Power On	The projector automatically turns on when electrical power is connected.
Auto Power Off (min)	Automatically turns the projector off after no signals are detected for a preset number of minutes. If an active signal is received before the projector powers down, the image will be displayed.

ITEM	DESCRIPTION
Sleep Timer (min)	This item allows the projector to automatically power off after it has been on for a specified amount of time.
Quick Resume	<ul style="list-style-type: none"> On: If the projector is accidentally turned off, this feature allows the projector to be instantly powered on again, if selected within a period of 100 seconds. Off: The fan will start cooling the system after 10 seconds when user turns off the projector. Quick Resume is not supported for WUXGA models due to the Power Down Refresh Mode.
Standby Power Mode	Set the standby power mode. <ul style="list-style-type: none"> Normal: Choose "Normal" to return to normal standby Eco.: Choose "Eco." to save power dissipation further < 0.5W.

Lamp Settings Menu

Press the **Menu** button to open the OSD menu. Press the arrow keys (▲▼) to select **OPTIONS** and press the **Enter** button to enter the **OPTIONS** menu. Press the arrow keys (▲▼) to select **Lamp Settings** and press the **Enter** button to enter the **Lamp Settings** menu. Press the arrow keys (▲▼) to select the menu option and press the **Enter** button to enter its submenu. Press the arrow keys (▲▼◀▶) to select or adjust the desired settings and press the **Enter** button to confirm.

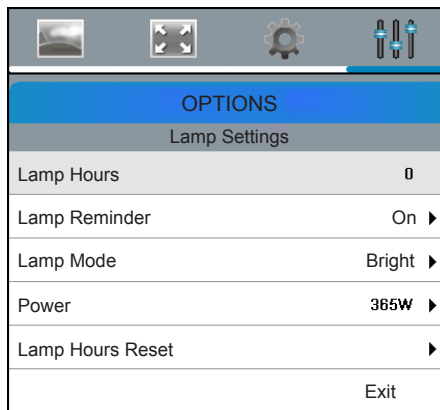

ITEM	DESCRIPTION
Lamp Hours	Display the projection time.
Lamp Reminder	Choose this function to show or to hide the warning message when the changing lamp message is displayed. The message will appear 30 hours before suggested replacement of lamp.
Lamp Mode	Select Bright , Eco , or Power mode. When in Eco mode, the projector will adjust to the lowest fan speed and switch the light source power to the minimum setting.
Power	Set the value of the light source power (in Watts).
Lamp Hours Reset	Reset the lamp used hours counter to zero. Do this after changing the lamp.

Optional Filter Settings Menu

Press the **Menu** button to open the OSD menu. Press the arrow keys (▲▼) to select **OPTIONS** and press the **Enter** button to enter the **OPTIONS** menu. Press the arrow keys (▲▼) to select **Optional Filter Settings** and press the **Enter** button to enter the **Optional Filter Settings** menu. Press the arrow keys (▲▼) to select the menu option and press the **Enter** button to enter its submenu. Press the arrow keys (▲▼◀▶) to select or adjust the desired settings and press the **Enter** button to confirm.

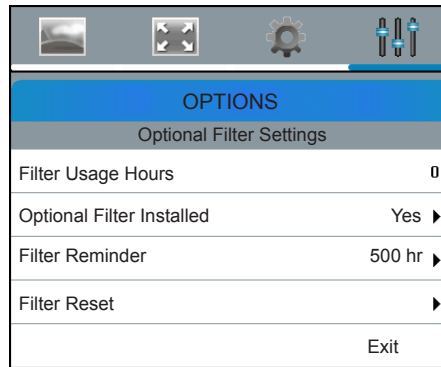

ITEM	DESCRIPTION
Filter Usage Hours	Display the filter time.
Optional Filter Installed	<ul style="list-style-type: none"> • Yes: Display warning message after 500 hours of use. • No: Turn off warning message. <div style="border: 1px solid black; padding: 5px; margin-top: 5px;"> <p>Note: “Filter Usage Hours / Filter Reminder / Filter Reset” will only appear when “Optional Filter Installed” is “Yes”.</p> </div>
Filter Reminder	Choose this function to show or hide the warning message when the changing filter message is displayed. (Factory default setting: 500 hours).
Filter Reset	Reset the dust filter counter after replacing or cleaning the dust filter.

Control Your Projector Using Web Browser

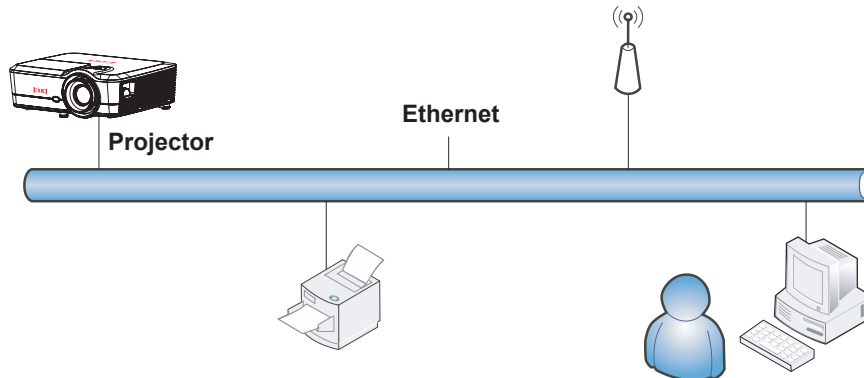

Wired LAN Terminal functionalities

Remote control and monitoring of a projector from a PC (or Laptop) via wired LAN is also possible. Compatibility with Crestron control boxes enables not only collective projector management on a network but also management from a control panel on a PC (or Laptop) browser screen.

- Crestron is a registered trademark of Crestron Electronics, Inc. of the United States.

Supported External Devices

This projector is supported by the specified commands of the Crestron Electronics controller and related software (ex, RoomView®).

<http://www.crestron.com/>

For more detail of information about the diverse types of external devices which can be connected to the Ethernet port and remote/control the projector, as well as the related control commands supporting for each external device, kindly please get contact with the Support-Service team directly.

LAN_RJ45

1. Connect an RJ45 cable to Ethernet port on the projector and the PC (Laptop).

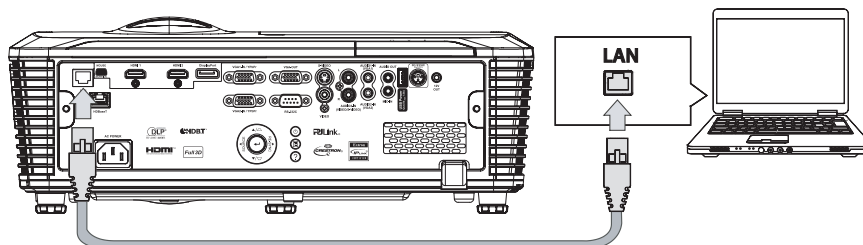

2. On the PC (Laptop), select **Start** → **Control Panel** → **Network and Internet**.

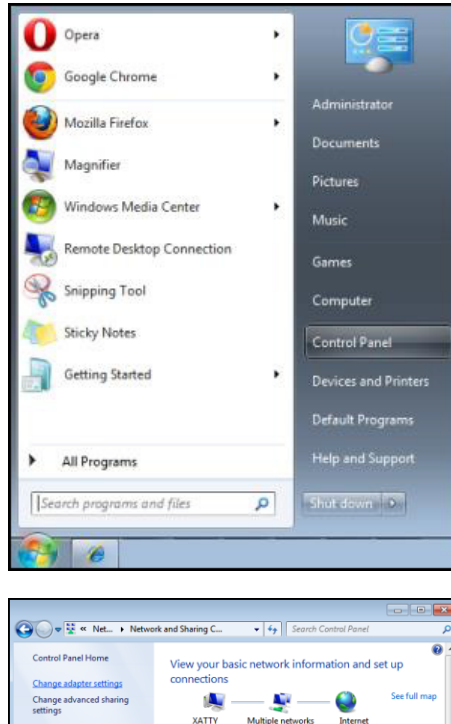

3. Right-click on **Local Area Connection**, and select **Properties**.

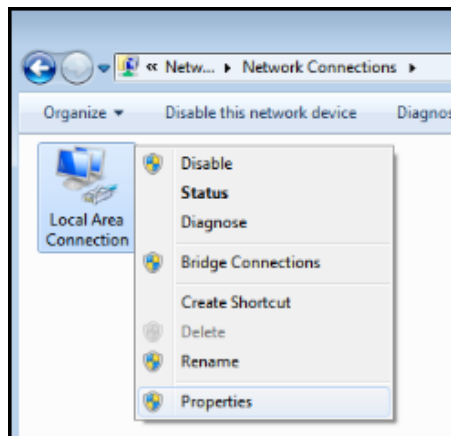

4. In the **Properties** window, select the **Networking** tab, and select **Internet Protocol (TCP/IP)**.

5. Click **Properties**.

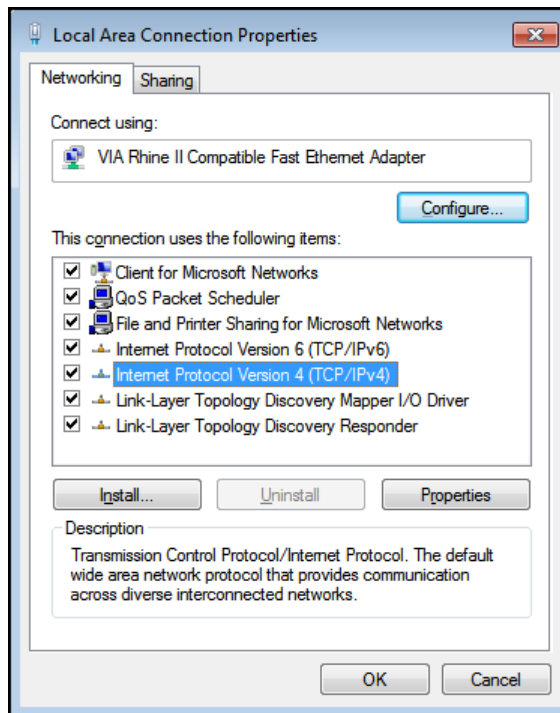

6. Click **Use the following IP address** and fill in the IP address and Subnet mask, then click **OK**.

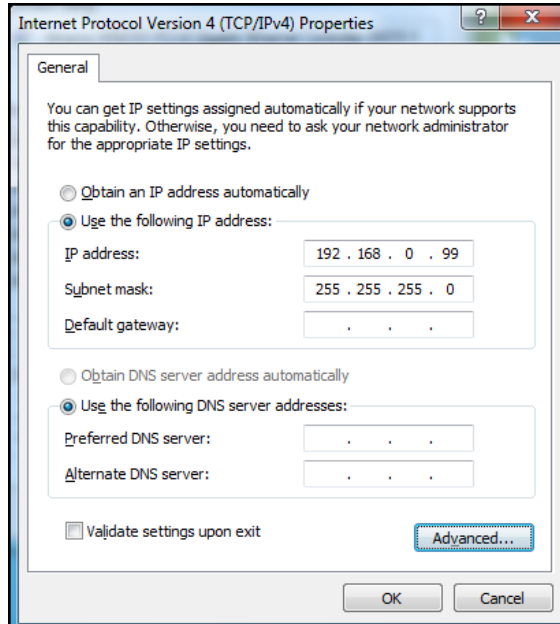

7. Press the **Menu** button on the projector.

8. Select **SETUP** → **Communications** → **LAN**.

9. After getting into **LAN**, input the following:

- DHCP: Off
- IP Address: 192.168.0.100
- Subnet Mask: 255.255.255.0
- Default Gateway: 0.0.0.0

10. Press the **Enter / ►** button to confirm settings.

Open a web browser (for example, Microsoft Internet Explorer with Adobe Flash Player 9.0 or higher).

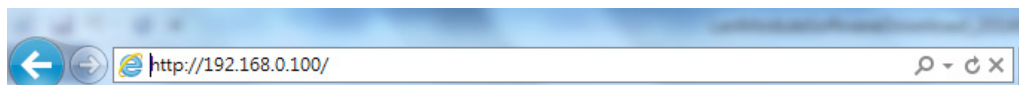

11. In the Address bar, input the IP address: 192.168.0.100.

12. Press the **Enter / ►** button.

The projector is setup for remote management. The LAN/RJ45 function displays as follows.



Model: EIKI		Tool	Info	Contact IT Help
<h1>EIKI</h1>				
Projector Information			Projector Status	
Projector Name	EIK-601W	Power Status	Power On.	
Location		Source	Displayport	
Firmware Version	C02.01	Color mode		
Mac Address	00.50.41.90.33.2D	Projector Position	Front-Desktop	
Resolution		Lamp Mode	Bright	
Lamp Hours	2	Error Status	0.No Error	
Assigned to	EIKI Projector			
<input type="button" value="exit"/>				
			Expansion Options	

CATEGORY	ITEM	INPUT-LENGTH
Crestron Control	IP Address	15
	IP ID	3
	Port	5
Projector	Projector Name	10
	Location	10
	Assigned To	10
Network Configuration	DHCP (Enabled)	(N/A)
	IP Address	15
	Subnet Mask	15
	Default Gateway	15
	DNS Server	15
User Password	Enabled	(N/A)
	New Password	10
	Confirm	10
Admin Password	Enabled	(N/A)
	New Password	10
	Confirm	10

For more information, please visit <http://www.crestron.com>.

RS232 by Telnet Function

Besides projector connected to RS232 interface with “Hyper-Terminal” communication by dedicated RS232 command control, there is alternative RS232 command control way, so called “RS232 by TELNET” for LAN/RJ45 interface.

Quick Start-Guide for “RS232 by TELNET”

Check and get the IP-Address on OSD of the projector.

Make sure that laptop/PC can access the web-page of the projector.

Make sure that “Windows Firewall” setting to be disabled in case of “TELNET” function filtering out by laptop/PC.

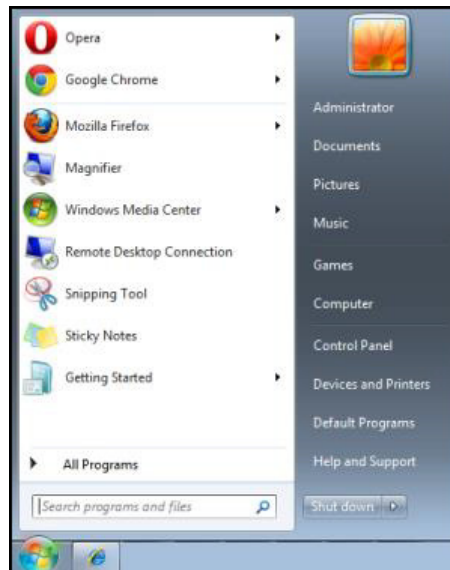

Start → All Programs → Accessories → Command Prompt

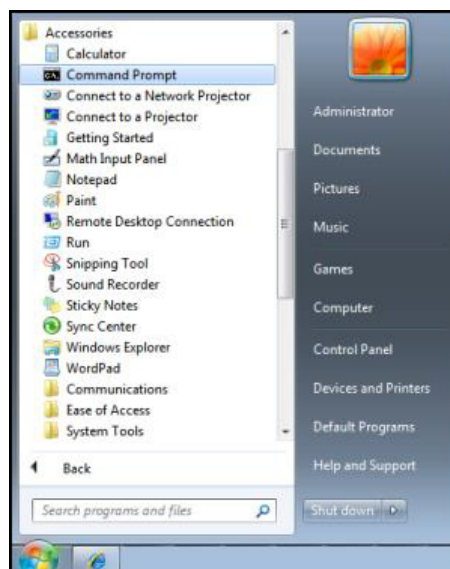

Input the command format like the below:

telnet ttt.xxx.yyy.zzz 3023 (the **Enter** button is pressed)

(**ttt.xxx.yyy.zzz**: IP-Address of the projector)

If Telnet-Connection ready, and user can have RS232 command input, then press the **Enter** button, the RS232 command will be workable.

How to have TELNET enabled in Windows VISTA / 7

By default installation for Windows VISTA, "TELNET" function is not included. But end-user can have it by way of "Turn Windows features On or Off" to be enabled.

1. Open "Control Panel" in Windows VISTA.

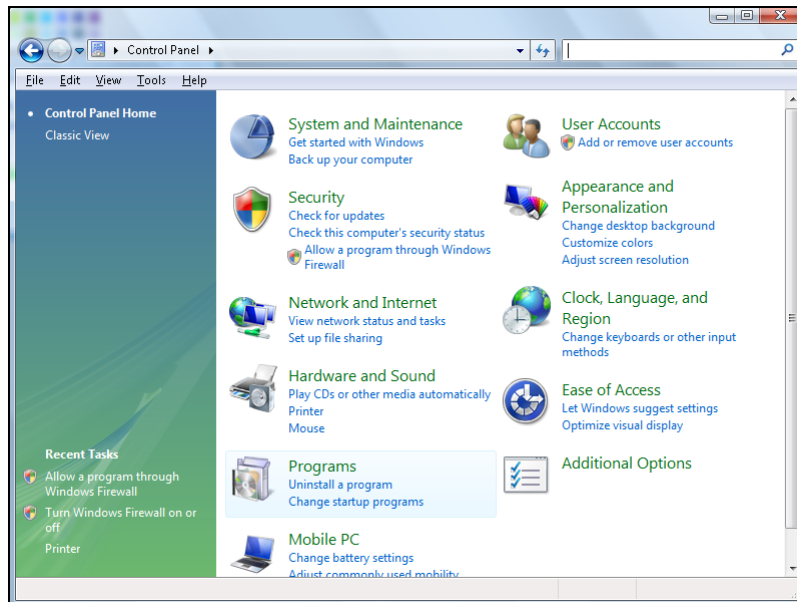

2. Open "Programs".

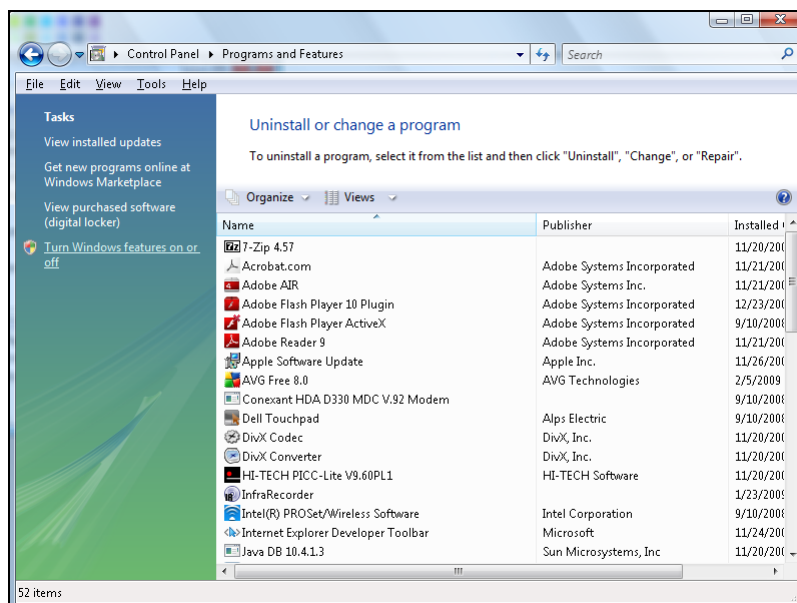

3. Select "Turn Windows features on or off" to open.

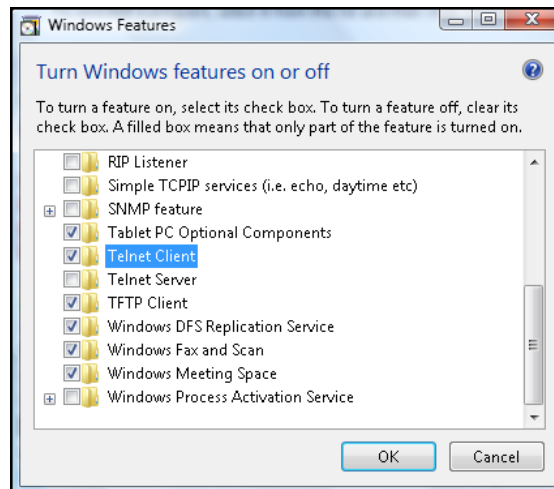

4. Have "Telnet Client" option checked, then click **OK**.

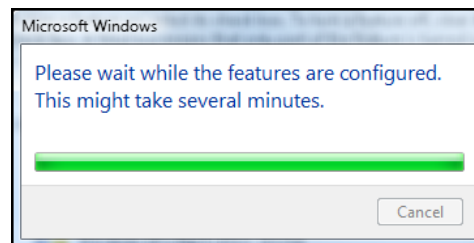

Specsheet for "RS232 by TELNET":

1. Telnet: TCP
2. Telnet port: 3023
(for more detail, kindly please get contact with the service agent or team)
3. Telnet utility: Windows "TELNET.exe" (console mode)
4. Disconnection for RS232-by-Telnet control normally: Close Windows Telnet utility directly after TELNET connection ready.
5. Limitation 1 for Telnet-Control: there is less than 50 bytes for successive network payload for Telnet-Control application.
Limitation 2 for Telnet-Control: there is less than 31 bytes for one complete RS232 command for Telnet-Control.
Limitation 3 for Telnet-Control: Minimum delay for next RS232 command must be more than 200 (ms).
(* , In Windows built-in "TELNET.exe" utility, pressing the **Enter** button will create a "Carriage-Return" and "New-Line" code.)

MAINTENANCE AND SECURITY

Replacing the Projection Lamp

The projection lamp should be replaced when it burns out. It should only be replaced with a certified replacement part, which you can order from your local dealer.

Lamp parts number : SP.74W01GC01

Important:

- *The projection lamp used in this product contains a small amount of mercury.*
- *Do not dispose this product with general household waste.*
- *Disposal of this product must be carried out in accordance with the regulations of your local authority.*

Warning:

Be sure to turn off and unplug the projector at least 30 minutes before replacing the lamp. Failure to do so could result in a severe burn.

Caution:

- *In rare cases the lamp bulb may burn out during normal operation and cause glass dust or shards to be discharged outward from the rear exhaust vent.*
- *Do not inhale or do not touch glass dust or shards. Doing so could result in injury.*
- *Always keep your face away from the exhaust vent so that you do not suffer from the gas and broken shards of the lamp.*
- *When removing the lamp from a ceiling-mounted projector, make sure that no one is under the projector. Glass fragments could fall if the lamp has been burned out.*



IF A LAMP EXPLODES

- *If a lamp explodes, the gas and broken shards may scatter inside the projector and they may come out of the exhaust vent. The gas contains toxic mercury.*
- *Open windows and doors for ventilation.*
- *If you inhale the gas or the shards of the broken lamp enter your eyes or mouth, consult the doctor immediately.*

Perform the following to replace the lamp:

- 1.** Turn the projector off. Allow the projector to cool down into standby mode.
- 2.** Remove the screw on the lamp door.

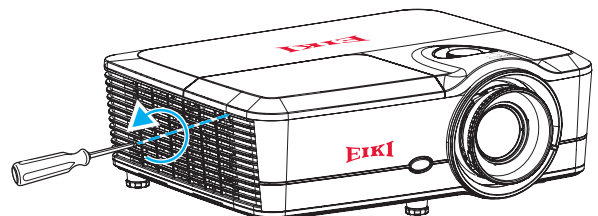

3. Remove the lamp door.

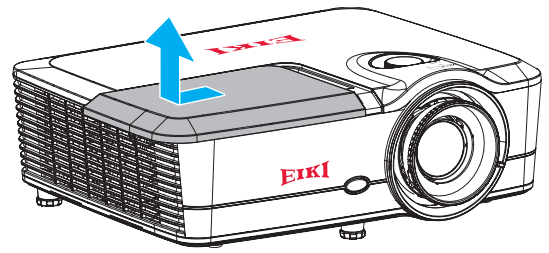

4. Lift up the lamp handle. Press on the both sides then lift up and remove the lamp cord.

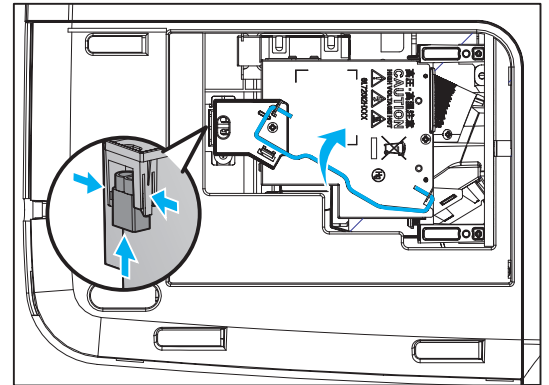

5. Remove the screws on the lamp module.

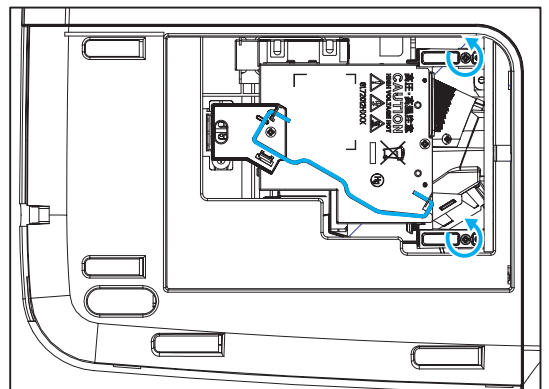

6. Lift up the lamp handle and remove the lamp module slowly and carefully.

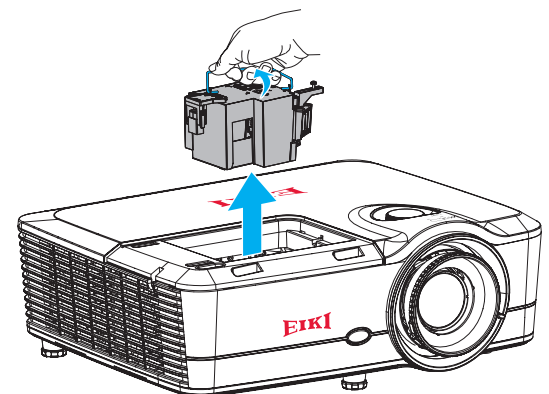

Resetting the Lamp

After replacing the lamp, you should reset the lamp hour counter to zero. Perform the following to reset the lamp hour counter:

1. Press the **Menu** button.

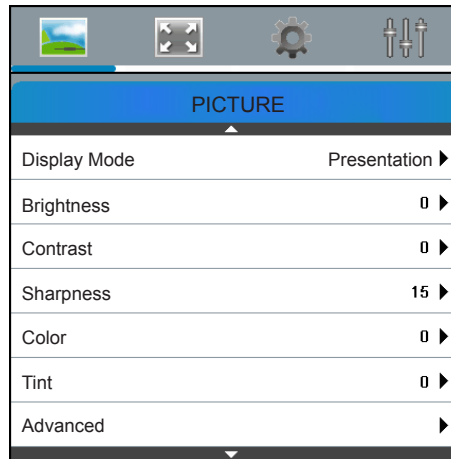

2. Use the arrow keys (▲▼) to select **OPTIONS** and press the **Enter** button to enter the **OPTIONS** menu.

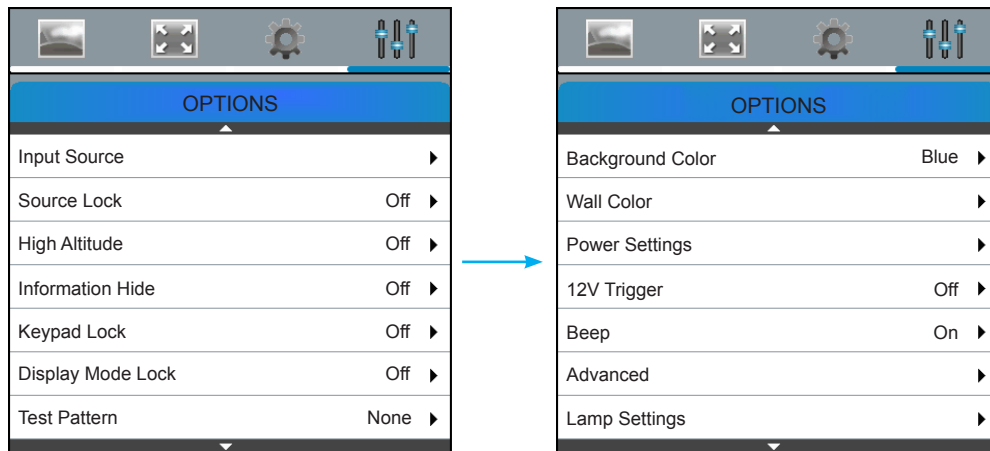

3. Use the arrow keys (▲▼) to select **Lamp Settings** and press the **Enter** button to enter its submenu.

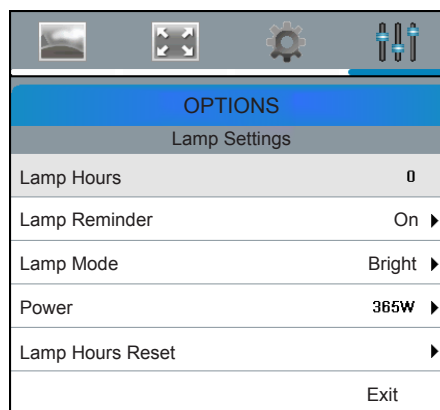

4. Use the arrow keys (▲▼) to select **Lamp Hours Reset** and press the **Enter** button to enter its submenu.
5. Use the arrow keys (▲▼) to select “Yes” and press the **Enter** button to reset the lamp used hours counter to zero.

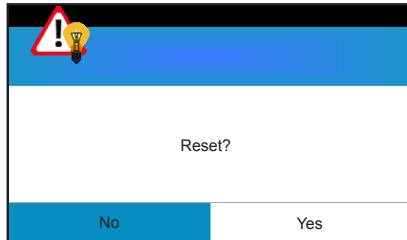

Replacing the Filter (Filter is optional.)

The interval of the filter replacement is affected by the dustiness. Check the filters periodically for better performance.

Filter parts number : 51.72025G001

Note:

Dirty filter may reduce the air flowing into the projector and the temperature in the projector may rise as the result. This may activate the protection mechanism or damage the components.

Important:

Check, clean, and replace the filter periodically.



Caution:

To avoid damage, you need to support the dust filter cover with your both hands when removing it.

Perform the following to replace the filter:

1. Turn the projector off. Allow the projector to cool down into standby mode.
2. Place the tips of your index fingers under the bottom edge of the dust filter cover.
3. Using the index finger and thumb of your both hands, hold the dust filter cover firmly.

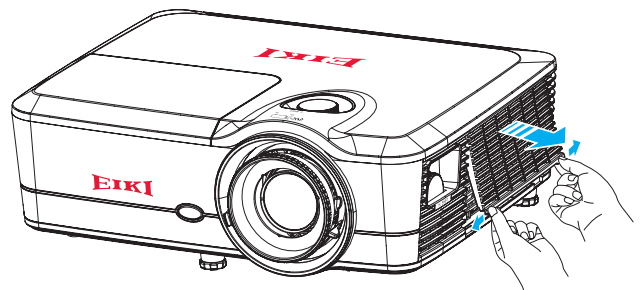

4. Slightly move the dust filter cover to the left and to the right direction to release it from the latches on the case. And then remove.

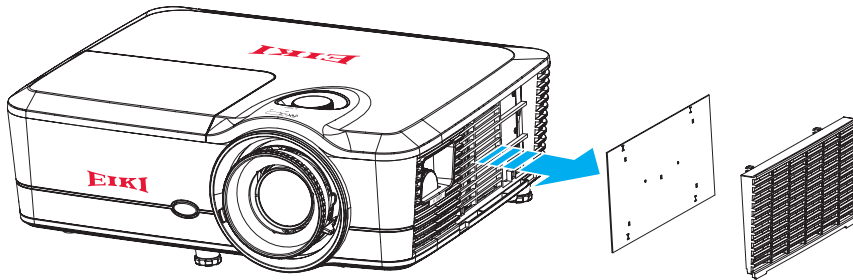

5. Install the new filter by reversing the previous steps.

Note:

Dust filters are only required/supplied in the selected regions with excessive dust.

Cleaning the Projector

Cleaning the projector to remove dust and grime will help ensure trouble-free operation.

Warning:

- *Be sure to turn off and unplug the projector at least 30 minutes before cleaning. Failure to do so could result in a severe burn.*
- *Use only a dampened cloth when cleaning. Do not allow water to enter the ventilation openings on the projector.*
- *If a little water gets into the projector interior while cleaning, leave unplugged in a well-ventilated room for several hours before using.*
- *If a lot of water gets into the projector interior when cleaning, have the projector serviced.*

Cleaning the Lens

You can purchase Optical lens cleaner from most camera stores. Refer to the following to clean the projector lens.

1. Apply a little Optical lens cleaner to a clean soft cloth. (Do not apply the cleaner directly to the lens.)
2. Lightly wipe the lens in a circular motion.

Caution:

- *Do not use abrasive cleaners or solvents.*
- *To prevent discoloration or fading, avoid getting cleaner on the projector case.*

Cleaning the Case

Refer to the following to clean the projector case.

1. Wipe off dust with a clean dampened cloth.
2. Moisten the cloth with warm water and mild detergent (such as used to wash dishes), and then wipe the case.
3. Rinse all detergent from the cloth and wipe the projector again.

Caution:

To prevent discoloration or fading of the case, do not use abrasive alcohol-based cleaners.

Using the Kensington® Lock

If you are concerned about security, attach the projector to a permanent object with the Kensington slot and a security cable.

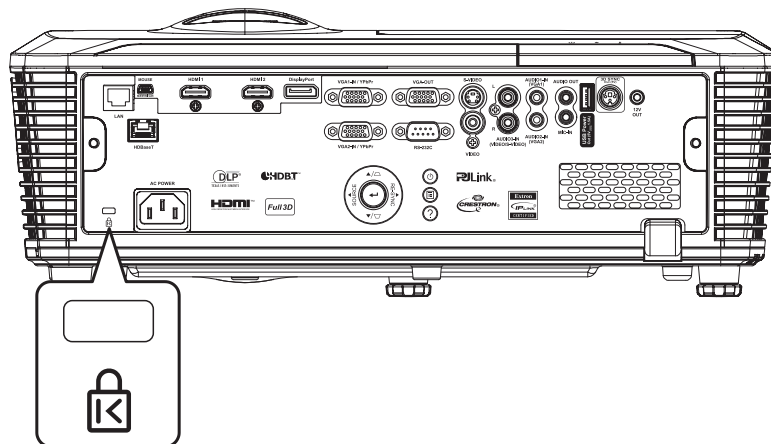

Note:

Contact your vendor for details on purchasing a suitable Kensington security cable. The security lock corresponds to Kensington's MicroSaver Security System. If you have any comment, contact: Kensington, 2853 Campus Drive, San Mateo, CA 94403, U.S.A. Tel: 800-535-4242, <http://www.Kensington.com>.

TROUBLESHOOTING

Common Problems and Solutions

These guidelines provide tips to deal with problems you may encounter while using the projector. If the problem remains unsolved, contact your dealer for assistance.

Often after time spent troubleshooting, the problem is traced to something as simple as a loose connection. Check the following before proceeding to the problem-specific solutions.

- Use some other electrical device to confirm that the electrical outlet is working.
- Ensure the projector is turned on.
- Ensure all connections are securely attached.
- Ensure the attached device is turned on.
- Ensure a connected PC is not in suspending mode.
- Ensure a connected notebook computer is configured for an external display. (This is usually done by pressing an Fn-key combination on the notebook.)

Tips for Troubleshooting

- In each problem-specific section, try the steps in the order suggested. This may help you to solve the problem more quickly.
- Try to pin point the problem and thus avoid replacing non-defective parts. For example, if you replace batteries and the problem remains, put the original batteries back and go to the next step.
- Keep a record of the steps you take when troubleshooting: The information may be useful when calling for technical support or for passing on to service personnel.

LED Error Messages

The LED status indicators are located on the top of the projector. Each LED is defined below.

- **Power LED**

LED STATUS		PROJECTOR STATE
RED	BLUE	
Steady Light	Off	Standby state (power cord connected).
Off	Flashing (0.5 second interval)	Power is on (warming) or power is off (cooling). Note: <i>If the projector is in cooling state and the power LED turns red then it indicates that the fan has turned off.</i>
Off	Flashing (Flashing (0.25 second interval)	The projector is in Quick Resume mode and can be powered on again within a 100 seconds.
Off	Flashing	Standby state, burnin (warning), or (burnin (cooling)).

- **Temp LED**

LED STATUS		PROJECTOR STATE
TEMP (RED)	POWER (RED)	
Flashing	Flashing	Fan has failed and is in error state.
Steady Light	Flashing	Over temperature. The projector will shut down.

- **Lamp LED**

LED STATUS		PROJECTOR STATE
LAMP (RED)	POWER (RED)	
Steady Light	Flashing	Lamp has failed and is in error state.

Image Problems

Problem: No image appears on the screen

1. Verify the settings on your notebook or desktop PC.
2. Turn off all equipment and power on again in the correct order.

Problem: The image is blurred

1. Use the **Focus** lever to adjust the focus on the projector.
2. Ensure the projector-to-screen distance is within the specified range.
3. Check that the projector lens is clean.

Problem: The image is wider at the top or bottom (trapezoid effect)

1. Position the projector so it is as perpendicular to the screen as possible.
2. Press the **Keystone V** button on the remote control or built-in keypad or manually adjust horizontal keystone to correct the problem.

Problem: The image is reversed

Check the **Rear** projection on the **Setup** menu of the OSD.

Problem: The image is streaked

1. Set the **Phase** and **Frequency** settings on the **Picture > Signal (VGA input)** menu of the OSD to the default settings.
2. Ensure the problem is not caused by a connected PC's video card, connect to another computer.

Problem: The image is flat with no contrast

Adjust the **Contrast** setting on the **Picture** menu of the OSD.

Problem: The color of the projected image does not match the source image

Adjust the **Color Temperature** and **Gamma** settings on the **Picture > Advanced** menu of the OSD.

Lamp Problems

Problem: There is no light from the projector

1. Check that the power cable is securely connected.
2. Ensure the power source is good by testing with another electrical device.
3. Restart the projector in the correct order and check that the Lamp LED has not turned to red.
4. If you have replaced the lamp recently, try resetting the lamp connections.

5. Replace the lamp module.
6. Put the old lamp back in the projector and have the projector serviced.

Problem: The lamp goes off

1. Power surges can cause the lamp to turn off. Re-plug power cord. Press “” on the built-in keypad or the remote control to turn off the projector.
2. Replace the lamp module.
3. Put the old lamp back in the projector and have the projector serviced.

Remote Control Problems

Problem: The projector does not respond to the remote control

1. Direct the remote control towards remote sensors on the projector.
2. Ensure the path between remote and sensor is not obstructed.
3. Turn off any fluorescent lights in the room.
4. Make sure that the batteries are installed with the correct polarity.
5. Replace the batteries.
6. Turn off other Infrared-enabled devices in the vicinity.
7. Have the remote control serviced.

Having the Projector Serviced

If you are unable to solve the problem, you should have the projector serviced. Pack the projector in the original carton. Include a description of the problem and a checklist of the steps you took when trying to fix the problem. The information may be useful to service personnel. For servicing, return the projector to the place you purchased it.

HDMI Q & A

Q. What is the difference between a “Standard” HDMI cable and a “High-Speed” HDMI cable?

Recently, HDMI Licensing, LLC announced that cables would be tested as Standard or High-Speed cables.

- Standard (or “category 1”) HDMI cables have been tested to perform at speeds of 75Mhz or up to 2.25Gbps, which is the equivalent of a 720p/1080i signal.
- High Speed (or “category 2”) HDMI cables have been tested to perform at speeds of 340Mhz or up to 10.2Gbps, which is the highest bandwidth currently available over an HDMI cable and can successfully handle 1080p signals including those at increased color depths and/or increased refresh rates from the Source. High-Speed cables are also able to accommodate higher resolution displays, such as WQXGA cinema monitors (resolution of 2560 x 1600).

Q. How do I run HDMI cables longer than 10 meters?

There are many HDMI Adopters working on HDMI solutions that extend a cable's effective distance from the typical 10 meter range to much longer lengths. These companies manufacture a variety of solutions that include active cables (active electronics built into cables that boost and extend the cable's signal), repeaters, amplifiers as well as CAT5/6 and fiber solutions.

Q. How can I tell if a cable is an HDMI certified cable?

All HDMI products are required to be certified by the manufacturer as part of the HDMI Compliance Test Specification. However, there may be instances where cables bearing the HDMI logo are available but have not been properly tested. HDMI Licensing, LLC actively investigates these instances to ensure that the HDMI trademark is properly used in the market. We recommend that consumers buy their cables from a reputable source and a company that is trusted.

For more detail information check <http://www.hdmi.org/learningcenter/faq.aspx#49>.

Specifications

ITEM	DESCRIPTION
Display type	0.67" DMD WUXGA/0.65" DMD WXGA
Resolution	1920X1200(WUXGA)/ 1280X800(WXGA)
Zoom/focus	Manual focus, automatic zoom
Zoom ratio	1.8x
Keystone correction	Vertical and Horizontal: +/- 30 degrees
Projection methods	Front, Rear, Fron-Ceiling, Rear-Ceiling
Data compatibility	VGA, SVGA, XGA, SXGA, Quad VGA, SXGA+, UXGA, WUXGA(RB), WSVGA, WXGA, WXGA+, WSXGA, WUXGA, PowerBook G4, i Mac DV(G3)
Video compatibility	480i/p, 576i/p, 720p, 1080i/p
H-Sync	15.375~91.146 kHz
V-Sync	24~85Hz, 120Hz for 3D mode
Safety Certification	cTUVus, FCC, CB, IEC 6247-5, CE EMC Report, CCC, CECP, VCCI, PSE
Operation temperature	5° ~ 40°C
Dimensions (W x H x D)	424x359.5x145 mm (w/o feet) 424x359.5x159 mm (with feet)
AC Input	100 VAC – 240 VAC
Power consumption	355W (ECO), 510W (Max. Full Mode)
Lamp	3000 hours at typical full power mode (445W) 4000 hours at Eco mode (355W)
Input Terminals	VGA-IN/YPbPr: D-sub 15-pin female connector for VGA input and component video input x 2 Audio-IN: Phone jack for audio input (3.5mm) x 3, RCA audio jacks for audio input x 2 MIC-IN: Phone jack for microphone input (3.5mm) x 1 Video: RCA jack for composite video input x 1 S-Video: Mini DIN 4-pin for S-video input x 1 HDMI: HDMI1.4b input x 2 DisplayPort: DisplayPort input x 1
Output Terminals	VGA-OUT: D-sub 15-pin female connector for VGA output x 1 Ethernet: RJ45 connector for network management Audio-OUT: Phone jack for audio output (3.5mm) x 1 3D Sync OUT: Mini din 3-pin VESA 3D sync output connector x 1
Control Terminals	RS-232C D-SUB 9-pin connector for HDBaseT firmware update and projector control x 1 USB-B Mini For firmware update x 1 USB Power OUT Type-A USB for power 5V/1.5A output.
Security	Kensington lock

Note:

For questions regarding product specifications, please contact your local distributor.

Compatible Resolution

ITEMS	MODE	RESOLUTION	FREQUENCY	
			V: [Hz]	H: [KHz]
1) VGA Analog – PC Signal	VGA	640x480	60	31.47
			72	37.86
			75	37.5
			85	43.27
	SVGA	800x600	56	35.2
			60	37.88
			72	48.08
			75	46.88
			85	53.67
	XGA	1024x768	60	48.36
			70	56.48
			75	60.02
			85	68.67
	SXGA	1152x864	70	63.8
			75	67.5
			85	77.1
		1280x1024	60	63.98
			72	77.9
			75	79.98
			85	91.15
		Quad VGA	1280x960	60
	75			75
	SXGA+	1400x1050	60	65.32
	UXGA	1600x1200	60	75
	WUXGA(RB)	1920x1200	60	74.038
	PowerBook G4	640x480	60	31.5
			66.6(67)	35
		800x600	60	37.88
1024x768		60	48.36	
1152x870		75	68.68	
	1280x960	75	75.2	
i Mac DV(G3)	1024x768	75	60.3	

ITEMS	MODE	RESOLUTION	FREQUENCY	
			V: [Hz]	H: [KHz]
(2) VGA Analog – Extended Wide timing	WSVGA	1024x600	60	37.3
	WXGA	1280x768	60	47.78
			75	60.29
			85	68.63
		1280x720	60	44.8
		1280x800	60	49.6
	1366x768	60	47.71	
	WXGA+	1440x900	60	55.9
	WSXGA	1680x1050	60	65.3
	WUXGA	1920x1080-RB	60	66.6
1920x1080-EIA		60	67.5	
(3) VGA Analog – Component signal	480i	720x480	59.94(29.97)	27
	480p		59.94	31.47
	576i	720x576	50(25)	27
	576p		50	31.25
	720p	1280x720	60	45
			50	37.5
	1080i	1920x1080	60(30)	33.75
			50(25)	33.75
	1080p		60	67.5
			50	56.25

ITEMS	MODE	RESOLUTION	FREQUENCY	
			V: [Hz]	H: [KHz]
(1) HDMI & Displayport – PC Signal	VGA	640x480	60	31.47
			72	37.86
			75	37.5
			85	43.27
	SVGA	800x600	56	35.2
			60	37.88
			72	48.08
			75	46.88
	XGA	1024x768	85	53.67
			60	48.36
			70	56.48
			75	60.02
	SXGA	1152x864	85	68.67
			70	63.8
			75	67.5
			85	77.1

ITEMS	MODE	RESOLUTION	FREQUENCY	
			V: [Hz]	H: [KHz]
(1) HDMI & Displayport – PC Signal	SXGA	1280x1024	60	63.98
			72	77.9
			75	79.98
			85	91.15
	Quad VGA	1280x960	60	60
			75	75
	SXGA+	1400x1050	60	65.32
	UXGA	1600x1200	60	75
	WUXGA(RB)	1920x1200	60	74.038
	PowerBook G4	640x480	60	31.5
			66.6(67)	35
		800x600	60	37.88
		1024x768	60	48.36
		1152x870	75	68.68
i Mac DV(G3)	1024x768	75	75.2	
		75	60.3	
(2) HDMI – Extended Wide timing	WSVGA	1024x600	60	37.3
	WXGA	1280x768	60	47.78
			75	60.29
			85	68.63
		1280x720	60	44.8
		1280x800	60	49.6
	1366x768	60	47.71	
	WXGA+	1440x900	60	55.9
	WSXGA	1680x1050	60	65.3
	WUXGA	1920x1080-RB	60	66.6
1920x1080-EIA		60	67.5	
1920x1200-RB		59.95	74.04	
(3) HDMI – Video signal	480i	720x480	59.94(29.97)	
	480p		27	
	576i	720x576	59.94	31.47
	576p		50(25)	27
	720p	1280x720	50	31.25
			60	45
	1080i	1920x1080	50	37.5
			60(30)	33.75
	50(25)		33.75	
	60		67.5	
50	56.25			
1080p	23.97/24	27		

Projector Dimensions

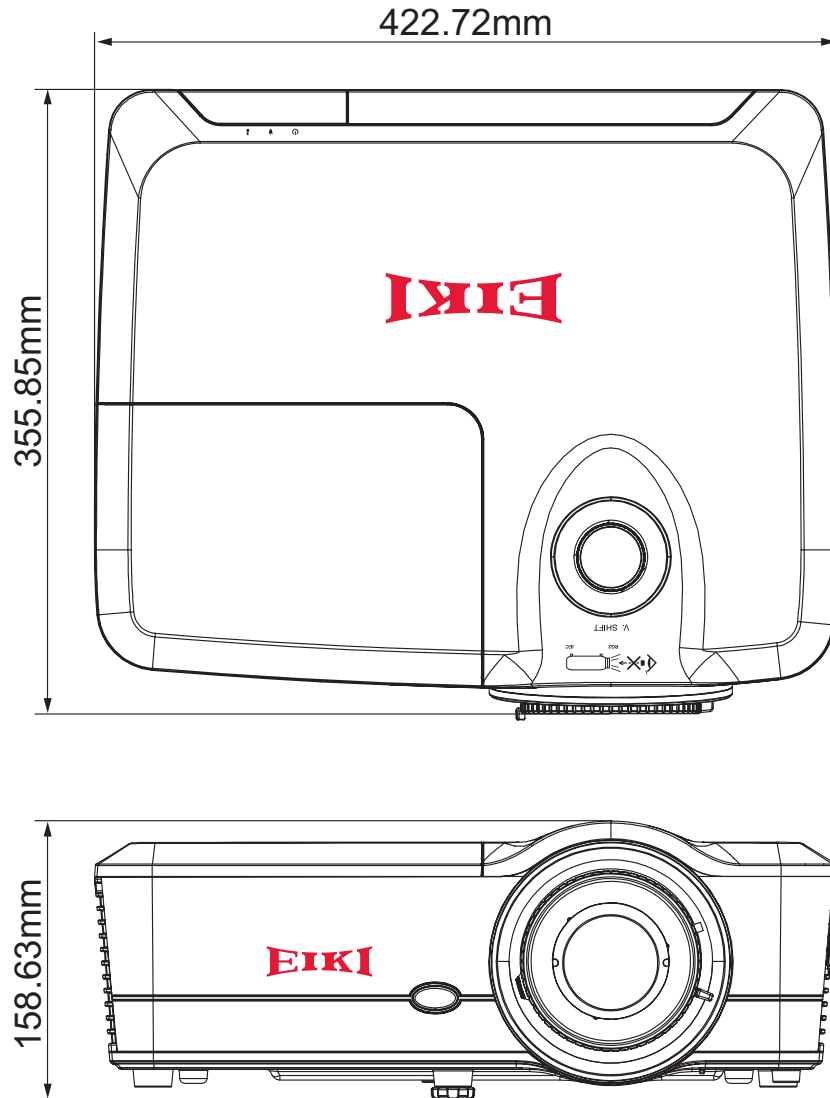

REGULATORY COMPLIANCE

FCC Warning

This equipment has been tested and found to comply with the limits for a Class A digital device pursuant to Part 15 of the FCC Rules. These limits are designed to provide reasonable protection against harmful interference when the equipment is operated in a commercial environment.

This equipment generates, uses, and can radiate radio frequency energy and, if not installed and used in accordance with the instruction manual, may cause harmful interference to radio communications. Operation of this equipment in a residential area is likely to cause harmful interference in which case the user will be required to correct the interference at his/her own expense.

Changes or modifications not expressly approved by the parties responsible for compliance could void the user's authority to operate the equipment.

Canada

This class A digital apparatus complies with Canadian ICES-003.

Safety Certifications

cTUVus, CB, IEC 62471-5, CE, CCC, CECF, VCCI, PSE

EIKI

U.S.A.

EIKI International, Inc.
30251 Esperanza
Rancho Santa Margarita
CA 92688-2132
U.S.A.
Tel: +1 800-242-3454 +1 949-457-0200
Fax: +1 800-457-3454 +1 949-457-7878
E-Mail: usa@eiki.com

Deutschland & Österreich

EIKI Deutschland GmbH
Am Frauwald 12
65510 Idstein
Deutschland
Tel: +49 6126-9371-0
Fax: +49 6126-9371-11
E-Mail: info@eiki.de

South East Asia

EIKI Industrial (M) Sdn Bhd
No. 11, Nouvelle Industrial Park,
Lorong Teknologi B, Taman Sains
Selangor 1, Kota Damansara PJU5,
47810 Petaling Jaya, Selangor Darul Ehsan,
Malaysia
Tel: +60 3-6157-9330
Fax: +60 3-6157-1320
E-Mail: sales@eiki.my

China

EIKI (Shanghai) Co., Ltd.
LAKESIDE OASIS MIDDLE RING
BUSINESS CENTRE
Block 1, Room 606,
1628, Jin Sha Jiang Road
Shanghai, 200333
CHINA
Tel: +86 21-3251-3993
Service Hot line: +86 21-3251-3995
Fax: +86 21-3251-3997
E-mail: info@eiki-china.com

Canada

EIKI CANADA - Eiki International, Inc.
P.O. Box 156, 310 First St. - Unit 2,
Midland, ON, L4R 4K8, Canada
Tel: +1 800-563-3454
+1 705-527-4084
E-Mail: canada@eiki.com

Eastern Europe

EIKI CZECH SPOL. s.r.o.
Nad Cementárnou 1163/4a
Praha 4, Podolí
147 00
Czech Republic
Tel: +420 241-410-928
+420 241-403-095
Fax: +420 241-409-435
E-Mail: info@eiki.cz

Oceania

EIKI AUSTRALIA PTY LTD
Level 5, 11 Queens Road,
Melbourne, Victoria 3004
Tel: +61 03-8530-7048
Fax: +61 03-9820-5834
E-Mail: sales@eiki.net.au

Japan & Worldwide

EIKI Industrial Company Limited.
6-23 Teramoto, Itami-shi, Hyogo,
664-0026 JAPAN
Tel: +81 72-782-7492
Fax: +81 72-781-5435

WorldWide Website <http://www.eiki.com>