

datavideo

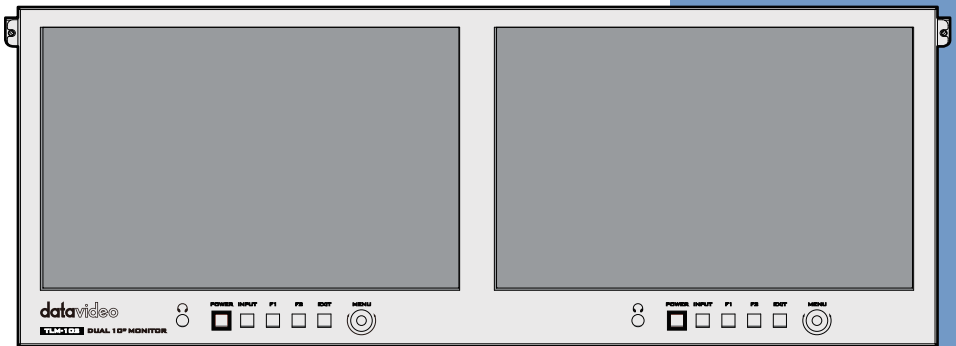

DUAL 10" MONITOR TLM-102 Instruction Manual

www.datavideo.com

Table of Contents

FCC COMPLIANCE STATEMENT	3
WARNINGS AND PRECAUTIONS	3
WARRANTY.....	4
STANDARD WARRANTY	4
THREE YEAR WARRANTY	5
DISPOSAL.....	5
1. INTRODUCTION.....	6
FEATURES	6
TLM-102 MODEL TYPE	7
COMPATIBLE RESOLUTIONS AND FORMATS.....	8
2. CONNECTIONS AND CONTROLS.....	9
FRONT PANEL.....	9
REAR PANEL.....	11
3. SOFTWARE FUNCTION	12
4. BUILT-IN SDI-HDMI CROSS-CONVERSION.....	13
5. OSD MENU.....	15
6. INSTALL THE TLM-102.....	17
7. DIMENSIONS.....	20
8. SPECIFICATIONS	21
9. ACCESSORIES.....	22
10. SERVICE AND SUPPORT	24

Disclaimer of Product and Services

The information offered in this instruction manual is intended as a guide only. At all times, Datavideo Technologies will try to give correct, complete and suitable information. However, Datavideo Technologies cannot exclude that some information in this manual, from time to time, may not be correct or may be incomplete. This manual may contain typing errors, omissions or incorrect information. Datavideo Technologies always recommend that you double check the information in this document for accuracy before making any purchase decision or using the product. Datavideo Technologies is not responsible for any omissions or errors, or for any subsequent loss or damage caused by using the information contained within this manual. Further advice on the content of this manual or on the product can be obtained by contacting your local Datavideo Office or dealer.

FCC Compliance Statement

This device complies with part 15 of the FCC rules. Operation is subject to the following two conditions:

1. This device may not cause harmful interference, and
2. This device must accept any interference received, including interference that may cause undesired operation.

Warnings and Precautions

1. Read all of these warnings and save them for later reference.
2. Follow all warnings and instructions marked on this unit.
3. Unplug this unit from the wall outlet before cleaning. Do not use liquid or aerosol cleaners. Use a damp cloth for cleaning.
4. Do not use this unit in or near water.
5. Do not place this unit on an unstable cart, stand, or table. The unit may fall, causing serious damage.
6. Slots and openings on the cabinet top, back, and bottom are provided for ventilation. To ensure safe and reliable operation of this unit, and to protect it from overheating, do not block or cover these openings. Do not place this unit on a bed, sofa, rug, or similar surface, as the ventilation openings on the bottom of the cabinet will be blocked. This unit should never be placed near or over a heat register or radiator. This unit should not be placed in a built-in installation unless proper ventilation is provided.
7. This product should only be operated from the type of power source indicated on the marking label of the AC adapter. If you are not sure of the type of power available, consult your Datavideo dealer or your local power company.
8. Do not allow anything to rest on the power cord. Do not locate this unit where the power cord will be walked on, rolled over, or otherwise stressed.
9. If an extension cord must be used with this unit, make sure that the total of the ampere ratings on the products plugged into the extension cord do not exceed the extension cord rating.
10. Make sure that the total amperes of all the units that are plugged into a single wall outlet do not exceed 15 amperes.
11. Never push objects of any kind into this unit through the cabinet ventilation slots, as they may touch dangerous voltage points or short out parts that could result in risk of fire or electric shock. Never spill liquid of any kind onto or into this unit.
12. Except as specifically explained elsewhere in this manual, do not attempt to service this product yourself. Opening or removing covers that are marked "Do Not Remove" may expose you to dangerous voltage points or other risks, and will void your warranty. Refer all service issues to qualified service personnel.

13. Unplug this product from the wall outlet and refer to qualified service personnel under the following conditions:
 - a. When the power cord is damaged or frayed;
 - b. When liquid has spilled into the unit;
 - c. When the product has been exposed to rain or water;
 - d. When the product does not operate normally under normal operating conditions. Adjust only those controls that are covered by the operating instructions in this manual; improper adjustment of other controls may result in damage to the unit and may often require extensive work by a qualified technician to restore the unit to normal operation;
 - e. When the product has been dropped or the cabinet has been damaged;
 - f. When the product exhibits a distinct change in performance, indicating a need for service.

Warranty

Standard Warranty

- Datavideo equipment are guaranteed against any manufacturing defects for one year from the date of purchase.
- The original purchase invoice or other documentary evidence should be supplied at the time of any request for repair under warranty.
- The product warranty period begins on the purchase date. If the purchase date is unknown, the product warranty period begins on the thirtieth day after shipment from a Datavideo office.
- All non-Datavideo manufactured products (product without Datavideo logo) have only one year warranty from the date of purchase.
- Damage caused by accident, misuse, unauthorized repairs, sand, grit or water is not covered under warranty.
- Viruses and malware infections on the computer systems are not covered under warranty.
- Any errors that are caused by unauthorized third-party software installations, which are not required by our computer systems, are not covered under warranty.
- All mail or transportation costs including insurance are at the expense of the owner.
- All other claims of any nature are not covered.
- All accessories including headphones, cables, and batteries are not covered under warranty.
- Warranty only valid in the country or region of purchase.
- Your statutory rights are not affected.

Three Year Warranty

- All Datavideo products purchased after July 1st, 2017 are qualified for a free two years extension to the standard warranty, providing the product is registered with Datavideo within 30 days of purchase.
- Certain parts with limited lifetime expectancy such as LCD panels, DVD drives, Hard Drive, Solid State Drive, SD Card, USB Thumb Drive, Lighting, Camera module, PCIe Card are covered for 1 year.
- The three-year warranty must be registered on Datavideo's official website or with your local Datavideo office or one of its authorized distributors within 30 days of purchase.

Disposal



recycling centre.

For EU Customers only - WEEE Marking.

This symbol on the product indicates that it should not be treated as household waste. It must be handed over to an applicable take-back scheme for the recycling of Waste Electrical and Electronic Equipment. For more detailed information about the recycling of this product, please contact your local Datavideo office or your local

1. Introduction

The Datavideo TLM-102 Dual 10" monitor is a 4RU Rack mount dual monitor which is designed for the broadcast quality monitoring application. Datavideo TLM-102's 4RU rack design, SDI and HDMI inputs and outputs and different mounting methods make it the best solution for various applications such as live vans, on-site monitoring and video wall.

The Datavideo TLM-102 Dual 10" monitor brings high quality and user friendly viewing experience for users via its excellent display quality and advanced auxiliary functions. Please see following chapters for more details about the TLM-102 Dual 10" monitor.

Features

- Dual 10" Monitor with 1280*800 IPS Panel Resolution.
- Dual Monitor with 4RU Rack Mount.
- Support 3G-SDI video input with loop-through output.
- Support HDMI video input with loop-through output.
- Support OSD menu for various functions including Column (YRGB peak), time code, waveform, vector scope, audio level meter, peaking, zoom, pix to pix, underscan, check field, etc.
- Support SDI & HDMI Cross Conversion.
- Individual adjustment of Brightness, Contrast, Color Saturation and LED Backlight Level for each monitor.
- Colour temperature menu option has 4 modes (6500K, 7500K,9300K and user defined)
- Support front panel headphone jack.
- Support 15 pin Tally input interface.
- Support User-definable function buttons F1 and F2

TLM-102 Model Type

Model	TLM-102
Image	
System	4U Rack Mount

Compatible Resolutions and Formats

Format	TLM-102 Interface	
	HDMI	SDI
1920x1080P @ 59.94	Support	Support
1920x1080P @ 60	Support	Support
1920x1080P @ 50	Support	Support
1920x1080P @ 29.97	Support	Support
1920x1080P @ 25	Support	Support
1920x1080P @ 30	Support	Support
1920x1080P @ 23.98	Support	Support
1920x1080P @ 24	Support	Support
1920x1080i @ 59.94	Support	Support
1920x1080i @ 60	Support	Support
1920x1080i @ 50	Support	Support
1280x720P @ 59.94	Support	Support
1280x720P @ 60	Support	Support
1280x720P @ 50	Support	Support
1280x720P @ 23.98	Support	Support
1280x720P @ 24	Support	Support
1280x720P @ 25	Support	Support
1280x720p@29.97	Support	Support
1280x720p@30	Support	Support
720 x 480i (NTSC)	Support	Support
720 x 576i (PAL)	Support	Support

2. Connections and Controls

Front Panel

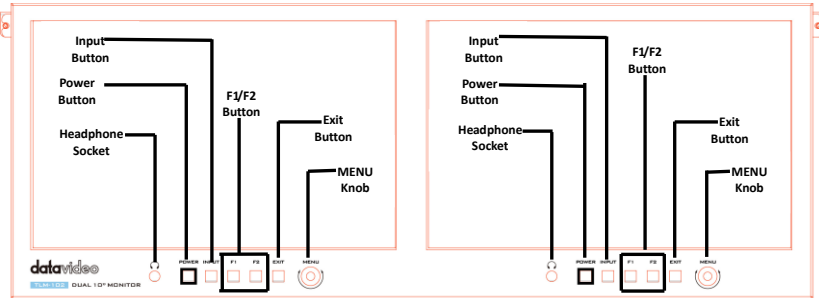

Buttons	Descriptions
Headphone Socket	3.5mm headphone socket.
Power Button	Press the power button to turn ON/OFF the monitor.
Input Button	This button is for users to select the input signal type. The available input interfaces are SDI and HDMI.
F1/F2 Button	<p>Long press any F1-F2 key for 3-5 seconds to pop-up shortcut menu directly. Select option via dialing to the left or right. Press to confirm option as default, then press EXIT to exit.</p> <p>Functions of F1-F2 buttons can also be customized: Center Marker, Aspect Marker, Check, Field, Underscan, Scan, Aspect, DSLR, Freeze, H/V delay, Peaking, False Color, Exposure, Histogram, Level Meter, Waveform and Time Code.</p> <p>Default function:</p>

	F1: Scan F2 :Waveform
Exit Button	Press the Exit button to exit or go back.
Menu Knob	<p>Menu Function: press to activate the menu displayed on screen.</p> <p>Option Function: select the options in the menu via dialing to the left or right.</p> <p>Confirm Function: press to confirm after option selected.</p> <p>Shortcut Function: Turn the Menu Knob to left or right, brightness will appear at the bottom of the screen, then press the Menu Knob to select brightness, sharpness, contrast, saturation, volume, tint, and Exit. User can adjust the parameters of the selected item by turning left or right to meet their needs.</p>

Rear Panel

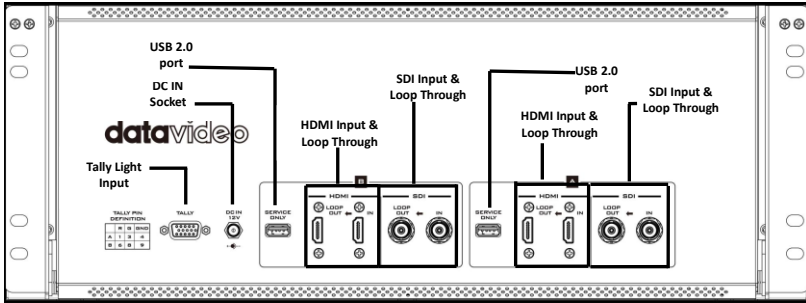

Ports	Descriptions													
Tally Light Input	Tally light information can be supplied to the TLM-102 from Datavideo's switchers via this socket. Pin1 and pin6 represent "Red". Pin3 and pin 8 represents "Green". Pin4 and pin9 represents "GND".	<p>TALLY PIN DEFINITION</p> <table border="1"> <tr> <td></td> <td>R</td> <td>G</td> <td>GND</td> </tr> <tr> <td>A</td> <td>1</td> <td>3</td> <td>4</td> </tr> <tr> <td>B</td> <td>6</td> <td>8</td> <td>9</td> </tr> </table>		R	G	GND	A	1	3	4	B	6	8	9
	R	G	GND											
A	1	3	4											
B	6	8	9											
Service Only USB Port	For service only. The two USB ports are used for maintenance, firmware update or further function upgrading Only by the original manufacturer. For customers, please DO NOT use these service ports.													
SDI Input & Loop Through	BNC input for HD / SD SDI with a loop through output.													
HDMI Input & Loop Through	Video and Audio input from an HDMI device.													
DC In Socket	DC In Socket for connecting 12V / 3A power supply. The connection can be secured by screwing the outer fastening ring of the DC In plug to the socket.													

Note 1: the interfaces within the monitor 1 only provide signal sources for the monitor1 and the interfaces within the monitor 2 provide signal sources for the monitor 2 only.

Note2: The Tally Light Input and 12V DC IN interfaces are common interfaces for both monitor 1 and monitor 2.

3. Software Function

Basic Functions	
Center Marker	●
Safety Marker	●
Aspect Marker	●
Aspect	●
Underscan	●
Pixel to Pixel	●
Zoom	●
H/V Delay	●
DSLR	●
Freeze	●
Check Field	●
Level Meter	●
TALLY	●
Advanced Functions	
Peaking	●
False Color	●
Exposure	●
Histogram	●
Waveform	●
Vector	●
Time Code	●
HDMI/SDI Convert	●
Color Bar	●

4. Built-in SDI-HDMI Cross-Conversion

The TLM-102 provides built-in SDI-HDMI cross-conversion function which is useful for users to convert SDI input signal into HDMI output signal or to convert HDMI input signal into SDI output signal. There are three modes for the SDI-HDMI cross conversion which are shown as follows.

- **Conversion Function is OFF**

When the conversion function is OFF, there is no impact on the output signal no matter the input signal format. So, when the conversion function is OFF, SDI IN signal will be SDI OUT signal and the HDMI IN signal will be HDMI OUT signal.

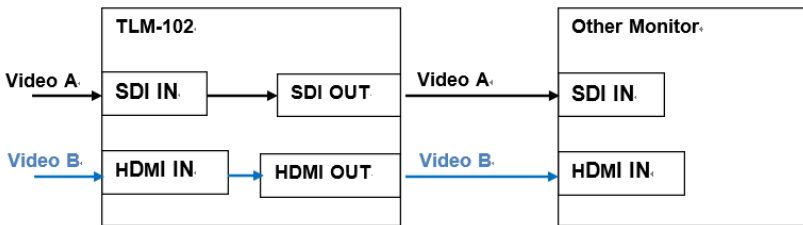

- **Conversion Function is ON (When the TLM-102 is switched to HDMI Screen)**

When the conversion function is ON and the TLM-102 is switched to the HDMI input screen, the cross-conversion function between SDI and HDMI signals will be activated. In this situation, the HDMI IN signal will be cross-converted to be the SDI OUT signal and the SDI IN signal will be cross-converted to be the HDMI OUT signal.

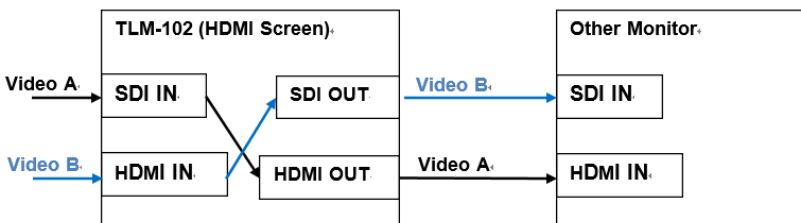

- **Conversion Function is ON (When the TLM-102 is switched to SDI Screen)**

When the conversion function is ON and the TLM-102 is switched to the SDI input screen, the cross-conversion function will be affected only for the SDI input signal. In this situation, the SDI input signal will pass-through to be the SDI OUT signal. So, the SDI OUT source will be SDI IN and the HDMI OUT source will also be SDI IN.

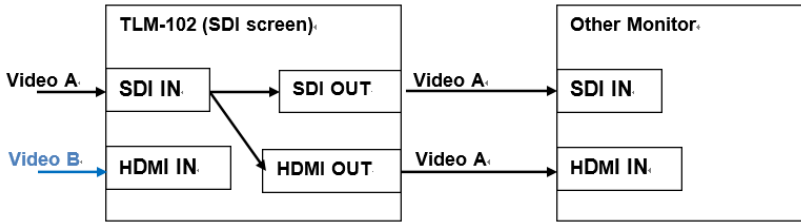

5. OSD Menu

The TLM-102 can be set up using an OSD menu system. To display the OSD menu, please press the MENU knob. This menu system is navigated using the knob to change a value or to highlight a menu option. Press the MENU Knob to select an option or confirm a value.

Main Options	Sub Options	Parameters
Picture	BRIGHTNESS	0~100
	CONTRAST	0~100
	SATURATION	0~100
	TINT	0~100
	Sharpness	0~100
	Color Temp.	6500K/7500K/9300K/User
Marker	Center Marker	On/Off
	Aspect Marker	Off/16:9/1.85:1/2.35:1/4:3/3:2
	Safety Marker	Off/95%/93%/90%/88%/85%/80%
	Marker Color	Red/Green/Blue/White/Black
	Marker Mat	Off/1~7
	Thickness	2/4/6
Function	Scan	Aspect/Pixel to Pixel/Zoom
	Aspect	Full/16:9/1.85:1/2.35:1/4:3/3:2
	Underscan	On/Off
	H/V Delay	OFF/H/V/HV
	Check Field	OFF/RED/GREEN/BLUE
	Zoom	10%~90%
	Freeze	On/Off
	DSLR	Off/5D2/5D3 (under HDMI)
Waveform	3G Format	Normal GBRA444 10 YCbCrA444 10 YCbCrA422 12 GBR444 12 YCbCr444 12 (under SDI)
	Waveform	Off/Multi/Y/YCbCr/RGB
	Waveform Trans.	Off/20%/50%
	Peaking	Off/On
	Peaking Color	Red/Green/Blue/White
	Peaking Level	0~100
	False Color	On/Off
	Exposure	On/Off
Exposure Level	0~100	
	Histogram	Off/Y/RGB/Color

	Time Code	Off/LTC/VITC(under SDI)
Audio	Volume	0~100
	Level Meter	On/Off
	Audio Ch	Ch1&Ch2 (under SDI)
	Language	English/Chinese
System	HDMI/SDI Convert	On/Off
	Color Bar	On/100%/75%
	OSD Timer	10s/20s/30s
	Back light	0 ~100
	Reset	On/Off
	Version	V1.0

6. Install the TLM-102

For installing the TLM-102 Dual 10" monitor, please refer to following diagrams.

1.

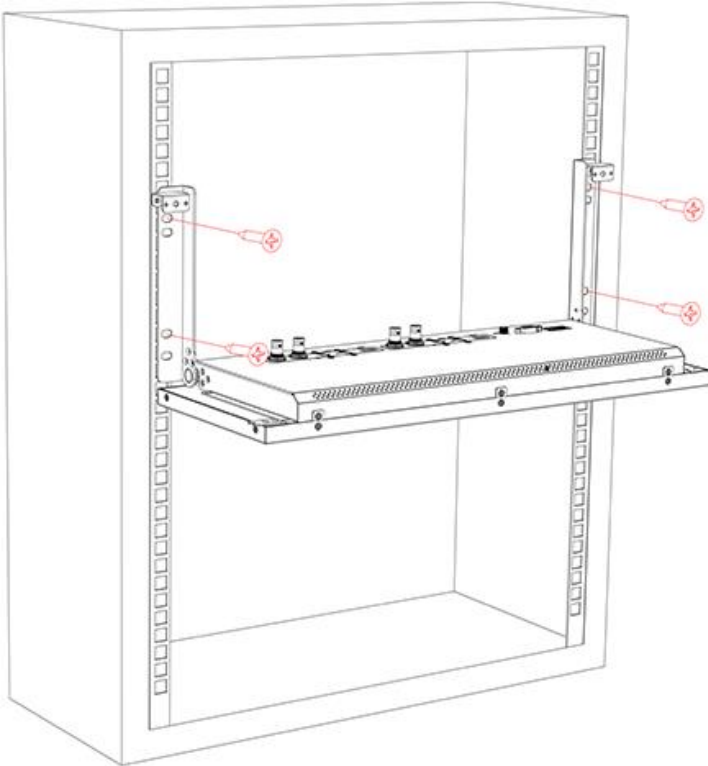

2.

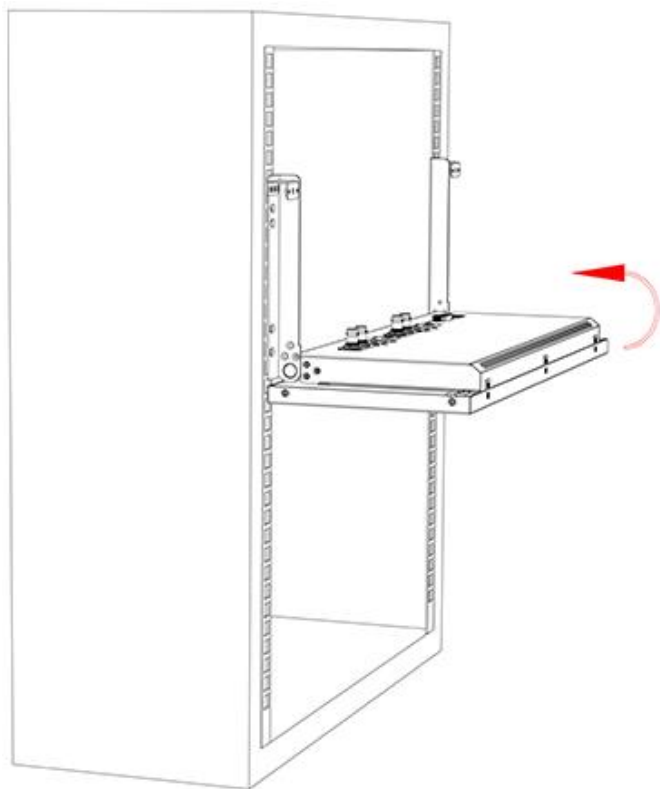

3.

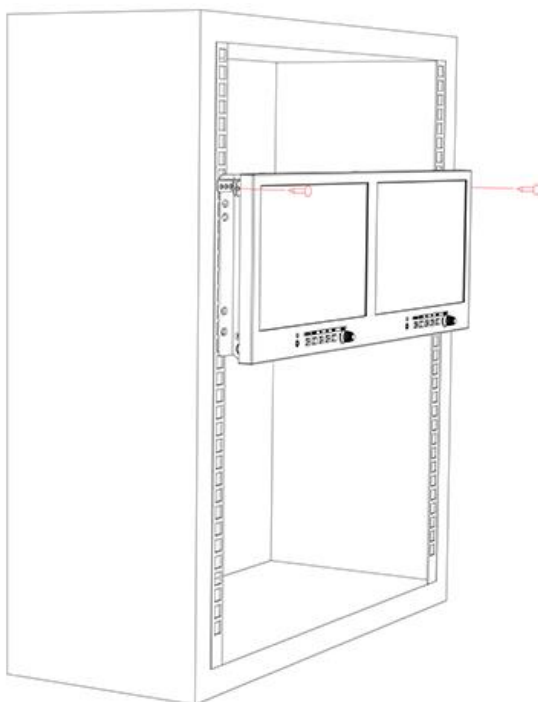

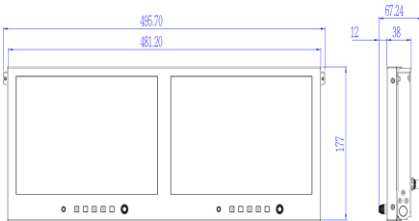
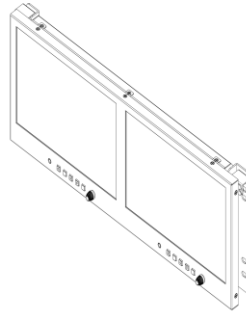
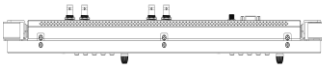

7. Dimensions



8. Specifications

Model Name	TLM-102
Product Name	Dual 10" Monitor
Screen	10.1" LCD
Chassis	4RU Rack Mount
Resolution	1280 x 800
Viewing Angle	(H) 170° (V) 170°
Luminance/Contrast	300 cd/m ² 800:1
Video Input	2x 3G/HD/SD-SDI 2x HDMI
Loop Through	2x 3G/HD/SD-SDI 2x HDMI
Support Input Resolutions	1080p (23.98/24/25/29.97/30/50/59.94/60Hz), 1080i (50/59.94/60Hz), 720p (23.98/24/25/29.97/30/50/59.94/60Hz), 480i (NTSC), 576i (PAL)
Aspect Ratio	16:9, 4:3
Tally LED	Live (Red) Cued (Green)
Audio In/OUT	Embedded Audio on SDI and HDMI Headphone Jack
Special Features	Time Code, Waveform, Vector Scope & Audio Level Meter, Peaking, Zoom, Pix to Pix, Underscan, SDI, HDMI Cross Conversion
Power	DC 12V, 28W
Service	USB x 2
Operating Temperature	-10°C ~ 40°C (14°F-104°F)
Storage Temperature	-40°C ~ 60°C(-40°F-140°F)
Dimension(mm)	482.5(L)× 178(W)× 38(D) mm
Weight	3.6Kg
Accessory	TALLY× 1 piece 12V DC adapter× 1 piece Manual× 1copy

9. Accessories

 1	 2	 3
Accessories	Quantity	
1. DC 12V Power adapter	1 piece	
2. Tally Connector	1 piece	
3. Manual	1 piece	

Note

Service & Support

It is our goal to make your products ownership a satisfying experience. Our supporting staff is available to assist you in setting up and operating your system. Please refer to our web site www.datavideo.com for answers to common questions, support requests or contact your local office below.



Please visit our website for latest manual update.

https://www.datavideo.com/product/TLM-102_

datavideo
www.datavideo.com



@DatavideoUSA @DatavideoIndia2016
@DatavideoEMEA @Datavideojapan
@DatavideoTaiwan @DatavideoLatam
@DatavideoAsia @DatavideoBrasil



@Datavideo
@Datavideo_EMEA
@Datavideo_Taiwan



@DatavideoUSA
@DVTWDCVN



@DatavideoUSA
@DatavideoEurope

All the trademarks are the properties of their respective owners.
Datavideo Technologies Co., Ltd. All rights reserved 2020