



®

HOSPITALITY & SPECIALTY  
COMMUNICATIONS

# DX121

## One-to-One Wireless Intercom System



### Operating Instructions

---

**HM ELECTRONICS, INC.**

2848 Whiptail Loop, Carlsbad, CA 92010 USA  
Phone: 1-800-848-4468 Fax: 858-552-0172  
Website: [www.hme.com](http://www.hme.com) Email: [support@hme.com](mailto:support@hme.com)

HME# 400G749  
Rev. B 3/16/18



# Table of Contents

<b>SECTION 1. INTRODUCTION . . . . .</b>	<b>2</b>
Typical DX121 Applications. . . . .	2
Equipment Identification . . . . .	4
Main Equipment Features . . . . .	5
<b>SECTION 2. BASE STATION SETUP . . . . .</b>	<b>7</b>
Basic Base Station Setup . . . . .	7
AC50 Battery Charger Setup . . . . .	8
Beltpac / All-In-One Headset Setup and Registration . . . . .	12
Intercom and Relay Connections . . . . .	16
<b>SECTION 3. EQUIPMENT OPERATION. . . . .</b>	<b>17</b>
Base Station Operation. . . . .	17
Beltpac Operation . . . . .	18
All-In-One Headset Operation . . . . .	20
<b>SECTION 4. TROUBLESHOOTING . . . . .</b>	<b>22</b>
<b>SECTION 5. DX SERIES LED AID. . . . .</b>	<b>23</b>
Syncing Secondary to Primary Bases Feature . . . . .	23
<b>SECTION 6. TECHNICAL DATA. . . . .</b>	<b>25</b>
DX121 Equipment Specifications. . . . .	25
<b>SECTION 7. INDEX. . . . .</b>	<b>27</b>
<b>BASE STATION BLOCK DIAGRAM . . . . .</b>	<b>28</b>

Illustrations in this publication are approximate representations of the actual equipment, and may not be exactly as the equipment appears.

HM Electronics, Inc. is not responsible for equipment malfunctions due to erroneous translation of its publications from their original English version.

## FCC NOTICE

This device complies with Part 15 of the FCC rules. Operation is subject to the following two conditions:

(1) This device may not cause harmful interference, and (2) This device must accept any interference received, including interference that may cause undesired operation.

**NOTE:** This equipment has been tested and found to comply with the limits for a Class A digital device, pursuant to Part 15 of the FCC rules. These limits are designed to provide reasonable protection against harmful interference when the equipment is operated in a commercial environment. This equipment generates, uses and can radiate radio frequency energy and, if not installed and used in accordance with the instruction manual, may cause harmful interference to radio communication. Operation of this equipment in a residential area is likely to cause harmful interference, in which case the user will be required to correct the interference at his own expense.

Changes or modifications not expressly approved by HM Electronics, Inc. could void the user's authority to operate this equipment.

## MANDATORY SAFETY INSTRUCTIONS FOR INSTALLERS AND USERS

Use only manufacturer or dealer supplied antennas.

The Federal Communications Commission has adopted a safety standard for human exposure to RF (Radio Frequency) energy, which is below the OSHA (Occupational Safety and Health Act) limits.

**Base Station Antenna minimum safe distance:** 7.9 inches (20 cm) at 100% duty cycle.

**Base Station Antenna gain:** This device has been designed to operate with an antenna having a maximum gain of up to 2dBi.

**Antenna mounting:** The antenna(s) used for the base transmitter must be installed to provide a separation distance of at least 7.9 inches (20 cm) from all persons and must not be co-located or operating in conjunction with any other antenna or transmitter.

**Antenna substitution:** Do not substitute any antenna for the one supplied by the manufacturer or radio dealer. You may be exposing person or persons to excess radio frequency radiation. You may contact your radio dealer or the manufacturer for further instructions.

**WARNING:** Maintain a separation distance from the Base Station transmit antenna to a person(s) of at least 7.9 inches (20 cm) at 100% duty cycle.

You, as the qualified end-user of this radio device must control the exposure conditions of bystanders to ensure the minimum separation distance (above) is maintained between the antenna and nearby persons for satisfying RF exposure compliance. The operation of this transmitter must satisfy the requirements of Occupational/Controlled Exposure Environment, for work-related use. Transmit only when person(s) are at least the minimum distance from the properly installed, externally mounted antenna.

## IC Notice to Users English/French in accordance with RSS GEN Issue 3

This device complies with Industry Canada license-exempt RSS standard(s). Operation is subject to the following two conditions: (1) this device may not cause interference, and (2) this device must accept any interference, including interference that may cause undesired operation of the device.

Cet appareil est conforme avec Industrie Canada RSS standard exempts de licence (s). Son utilisation est soumise à Les deux conditions suivantes: (1) cet appareil ne peut pas provoquer d'interférences et (2) cet appareil doit accepter Toute interférence, y compris les interférences qui peuvent causer un mauvais fonctionnement du dispositif.

This device complies with Health Canada's Safety Code 6 / IC RSS-210. The installer of this device should ensure that RF radiation is not emitted in excess of the Health Canada's requirement. Information can be obtained at: [http://www.hc-sc.gc.ca/ewh-semt/pubs/radiation/radio\\_guidelignes\\_direct-eng.php](http://www.hc-sc.gc.ca/ewh-semt/pubs/radiation/radio_guidelignes_direct-eng.php)

Cet appareil est conforme avec Santé Canada Code de sécurité 6 / IC RSS-210. Le programme d'installation de cet appareil doit s'assurer que les rayonnements RF n'est pas émis au-delà de l'exigence de Santé Canada. Les informations peuvent être obtenues:

Hereby, HM Electronics, Inc. declares that the DX121 is in compliance with the essential requirements and other relevant provisions of R&TTE Directive 1999/5/EC.



This product operates in the 2400 to 2483.5 MHz frequency range. The use of this frequency range is not yet harmonized between all countries. Some countries may restrict the use of a portion of this band or impose other restriction relating to power level or use. You should contact your Spectrum authority to determine possible restrictions.

## **Waste Electrical and Electronic Equipment (WEEE)**

The European Union (EU) WEEE Directive 2012/19/EU places an obligation on producers (manufacturers, distributors and/or retailers) to take-back electronic products at the end of their useful life. The WEEE Directive covers most HME products being sold into the EU as of August 13, 2005. Manufacturers, distributors and retailers are obliged to finance the costs of recovery from municipal collection points, reuse, and recycling of specified percentages per the WEEE requirements.

### **Instructions for Disposal of WEEE by Users in the European Union**

The symbol shown below is on the product or on its packaging which indicates that this product was put on the market after August 13, 2005 and must not be disposed of with other waste. Instead, it is the user's responsibility to dispose of the user's waste equipment by handing it over to a designated collection point for the recycling of WEEE. The separate collection and recycling of waste equipment at the time of disposal will help to conserve natural resources and ensure that it is recycled in a manner that protects human health and the environment. For more information about where you can drop off your waste equipment for recycling, please contact your local authority, your household waste disposal service or the seller from whom you purchased the product.



### Base Station



<b>Power</b>	<ul style="list-style-type: none"> <li>➤ Connect power — See <a href="#">page 8</a></li> <li>➤ Press <b>POWER</b> button to turn base station on/off — Red light above button indicates power on</li> <li>➤ BATT <b>PWR</b> light (not used in this product)</li> </ul>
<b>Belpac and Headset Registration</b>	<ul style="list-style-type: none"> <li>➤ Insert a charged battery</li> <li>➤ Press <b>REG</b> button on the base station to enter registration mode — See <a href="#">page 12</a></li> <li>➤ Hold down <b>ISO</b> button while you press and release <b>POWER</b> button on the headset or belpac</li> </ul>
<b>IC/ISO Indicators</b>	<ul style="list-style-type: none"> <li>➤ Green lights indicate IC or ISO communication is being received</li> </ul>
<b>Headset / 4-Wire Audio Level</b>	<ul style="list-style-type: none"> <li>➤ Adjust INbound/OUTbound headset and 4-Wire equipment audio levels using small screwdriver</li> </ul>
<b>Battery Charger</b>	<ul style="list-style-type: none"> <li>➤ Place battery in port for charging</li> <li>➤ Red CHG light indicates battery is charging</li> <li>➤ Green RDY light indicates fully-charged battery is ready</li> </ul>

### Headset



- Power on/off
- Volume up
- Volume down
- Intercom
- Isolate

### Belpac



- Power on/off
- Volume up
- Volume down
- Intercom
- Isolate

### Hands Free (HF)

### Push-To-Talk (PTT)

### ISO Lockout

<b>Mode Setup</b>	<ul style="list-style-type: none"> <li>➤ Power OFF</li> <li>➤ Press/hold  and  while you press/release </li> <li>➤ Release  and </li> </ul>	<ul style="list-style-type: none"> <li>➤ Power OFF</li> <li>➤ Press/hold  and  while you press/release</li> <li>➤ Release  and </li> </ul>	<ul style="list-style-type: none"> <li>➤ Power OFF</li> <li>➤ Press/hold  while you press/release </li> </ul>
			<p>To reset ISO —</p> <ul style="list-style-type: none"> <li>➤ Press/hold  and  while you press/release </li> </ul>
<b>Operation</b>	<ul style="list-style-type: none"> <li>➤ Press and release  or  quickly to latch into mode to talk to other users</li> <li>➤ Press/release again to unlatch and listen</li> </ul>	<ul style="list-style-type: none"> <li>➤ Press and hold  or  while talking to other users</li> <li>➤ Release to listen</li> </ul>	<ul style="list-style-type: none"> <li>➤ Use either  or  to talk to other users in HF or PTT</li> <li>➤  will not operate relay</li> </ul>

### Change Battery

If you hear “Change battery” —

- Remove battery from belpac
- Place battery in battery-charger port for recharging
- Install fully charged battery in belpac

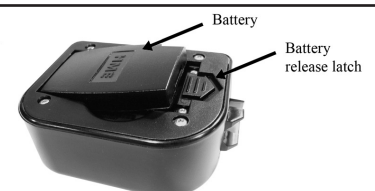

# SECTION 1. INTRODUCTION

The DX121 is a 2.4 GHz Wireless Intercom System. The Base Station will connect to a dynamic microphone headset jack or the 4-Wire connector of a hardwired intercom station. It also provides battery-charging capability for one battery. The system typically uses BP200 Beltpacs, but it can also be used with the WH220 All-in-One Headset. Once connected to your system, you can leave your console or intercom station while using a beltpac or headset.

- Each Base Station supports one beltpac or headset in full duplex, hands-free operation.
  - Each Base Station supports up to four registered beltpac or headset.
  - Compatible with RTS and ClearCom/Production Intercom wired intercom headset or 4-Wire capable equipment.
- NOTE:** Use only with headset connectors capable of supporting dynamic microphone headsets.
- In the default mode, the **ISO** button activates relay-controlled contacts. For alternate operating mode, see [Relay Operation](#) on page 16.
  - The **IC** button activates audio to the 4-Wire and headset Input/Output connector(s).
  - The **ISO** and **IC** buttons activate audio to other registered beltpacs and headsets.
  - The Base Station can charge a BAT41 battery in less than 3 hours.

## Typical DX121 Applications

### Large Venue

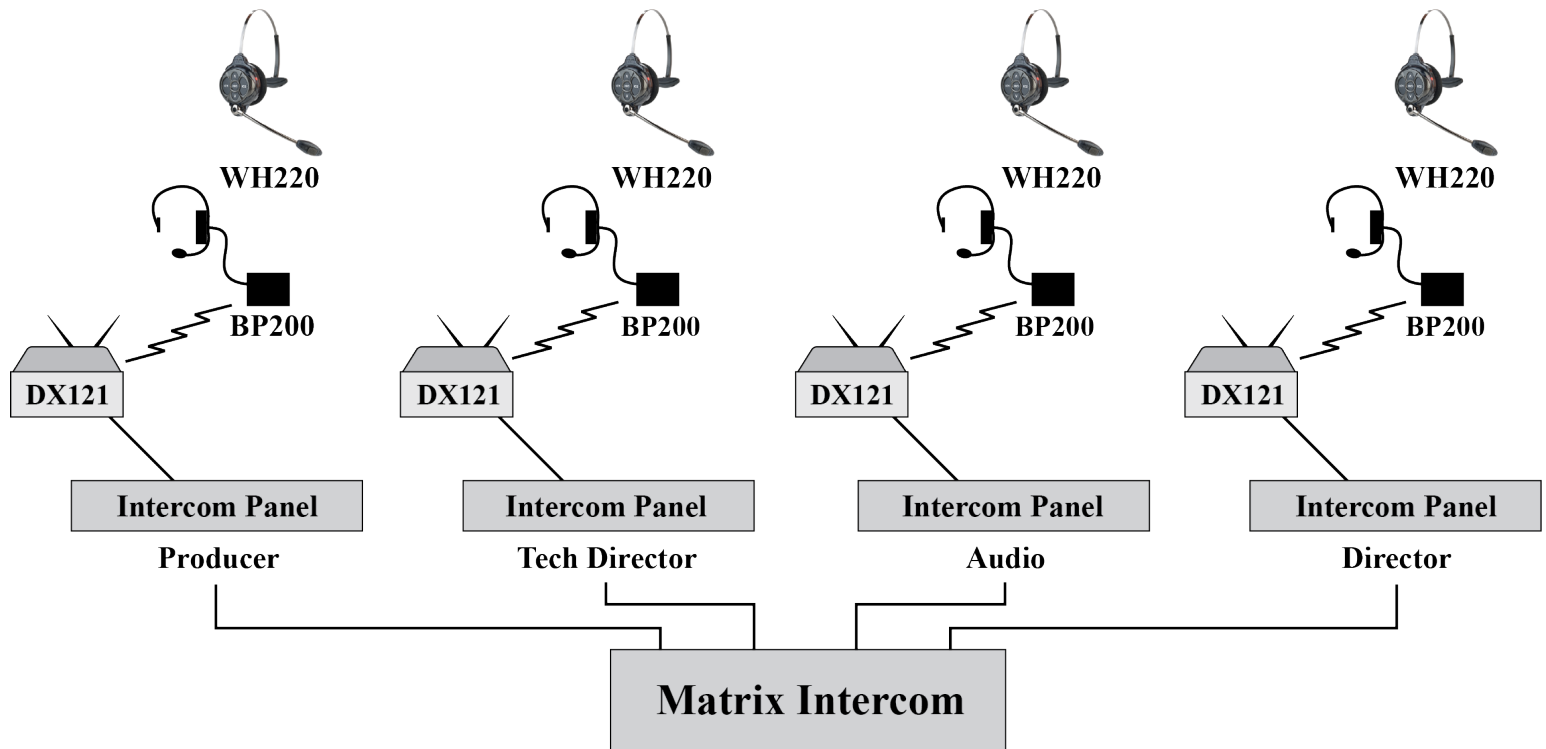

# Radio Communication Center

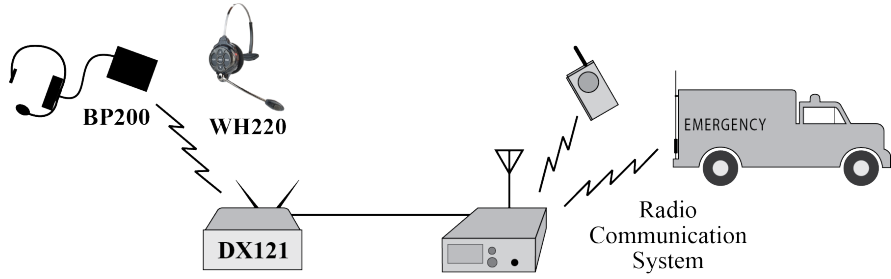

## Broadcasting

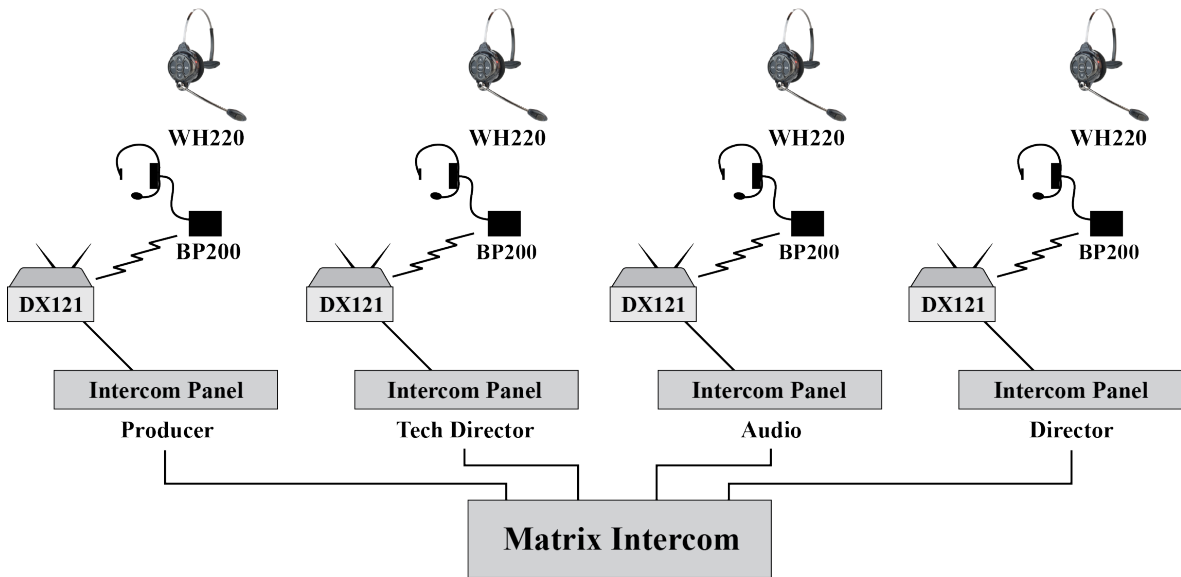

## Theater

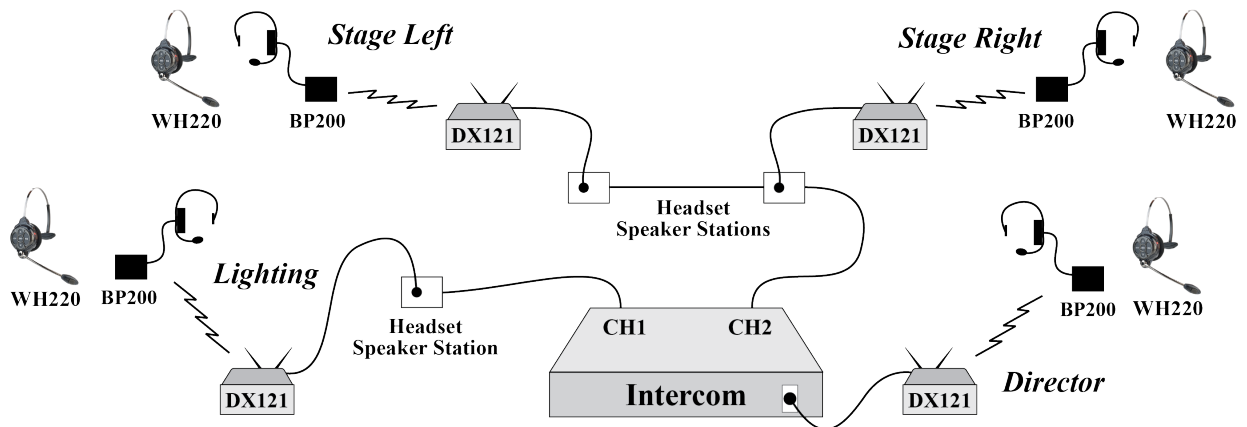



# Equipment Identification

The DX121 One-to-One Wireless Intercom System includes a base station and may include any combination of belt-pacs and headsets. Other optional equipment may also be used with your system. As you unpack the equipment, check the enclosed shipping document to be sure you received all items listed.

## Base Station



**BS121 Base Station**



**Base Station Antennas**  
(2 per Base Station)



**115/230 Volt AC Power Supply**  
(1 per Base Station, with Power Cord)

## Beltpac and Headset



**BP200 Beltpac**

**CC-15-MD4 Headset**

**Beltpac Pouch**



**WH220 All-in-One**  
Wireless Headset



**Battery (BAT41)**  
Two per Beltpac or All-in-One Headset



**Battery (BAT50)**  
Two per Beltpac or All-in-One Headset



**AC50 Battery Charger**  
**NOTE:** If you're using a WH220 with the MB121, you will need to purchase AC50 battery charger.

## OPTIONAL EQUIPMENT

- BP200 Beltpac
- CC-15-MD4 Single-Muff Headset
- CC-15-MD4 Dual-Muff Headset
- HS16 Lightweight Headset
- HS4-3 Earpiece & Lapel Microphone
- HSI6000 Headset Adapter
- WH220 All-in-One Headset
- BAT41 Rechargeable Battery
- BAT50 Rechargeable Battery
- AC50 Battery Charger

# Main Equipment Features

## Base Station Features

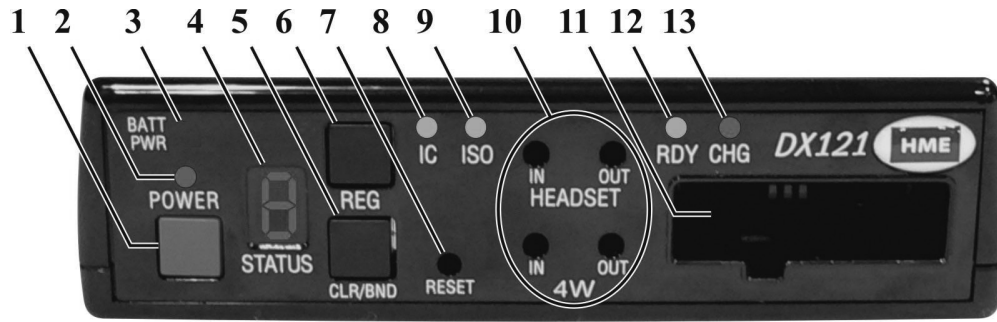

### Front Panel

1. **POWER** button
2. **POWER** light
3. **BATT PWR** light (not used)
4. **STATUS** display
5. **CLR/BND** (clear/band) button
6. **REG** (registration) button
7. **RESET** button (recessed)
8. **IC** indicator light
9. **ISO** indicator light
10. **HEADSET** and **4W** (4-Wire) **IN** and **OUT** audio level controls
11. Battery charger port (BAT41 battery only)
12. **RDY** (battery ready) light
13. **CHG** (battery charging) light

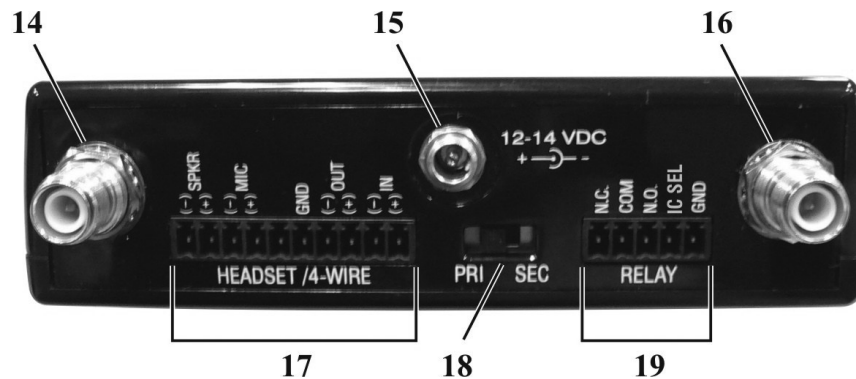

### Rear Panel

14. Antenna connector
15. **12-14 VDC** power supply connector
16. Antenna connector
17. **HEADSET / 4-WIRE** connector block
18. **PRI SEC** (primary/secondary) switch
19. **RELAY** connector block

## Beltpac Features

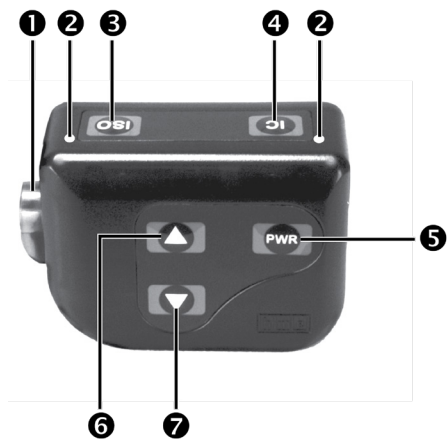

1. Headset cable connector
2. Beltpac power and transmit lights
3. **ISO** (Isolate) button
4. **IC** (Intercom) button
5. **PWR** (Power) button



6. Volume-up ▲ button
7. Volume-down ▼ button
8. Battery
9. Battery release latch

## WH220 Headset Features

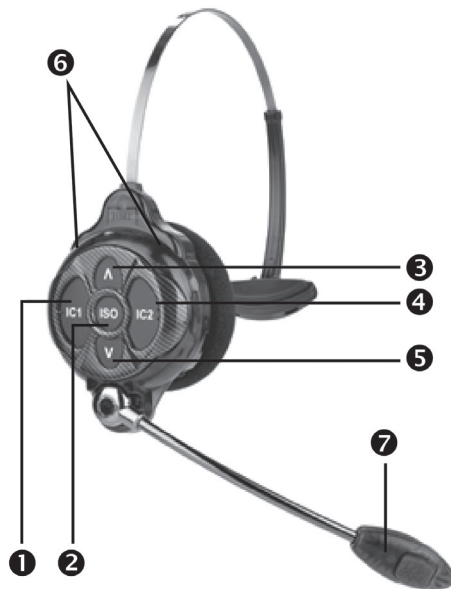

1. IC1 button
2. **ISO** (Isolate) button
3. Volume-up button
4. IC2 button
5. Volume-down button

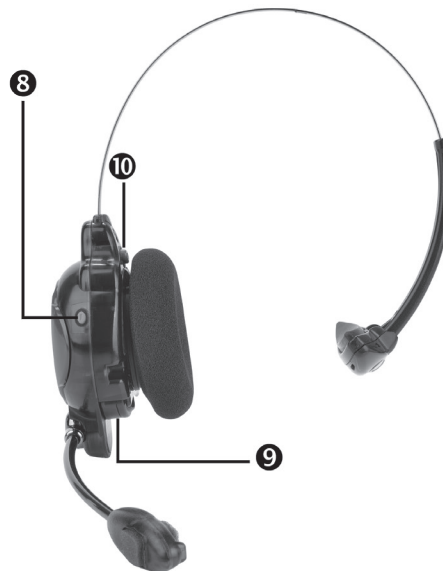

6. Power/mode lights
7. Microphone
8. Power button
9. Battery
10. Battery-release latch

## SECTION 2. BASE STATION SETUP

### Basic Base Station Setup

The following description is for a basic, stand-alone DX121 One-to-One Wireless Intercom System setup. Intercom headset, 4-Wire intercom and relay connections are described on [page 16](#).

Set up the Base Station as follows:

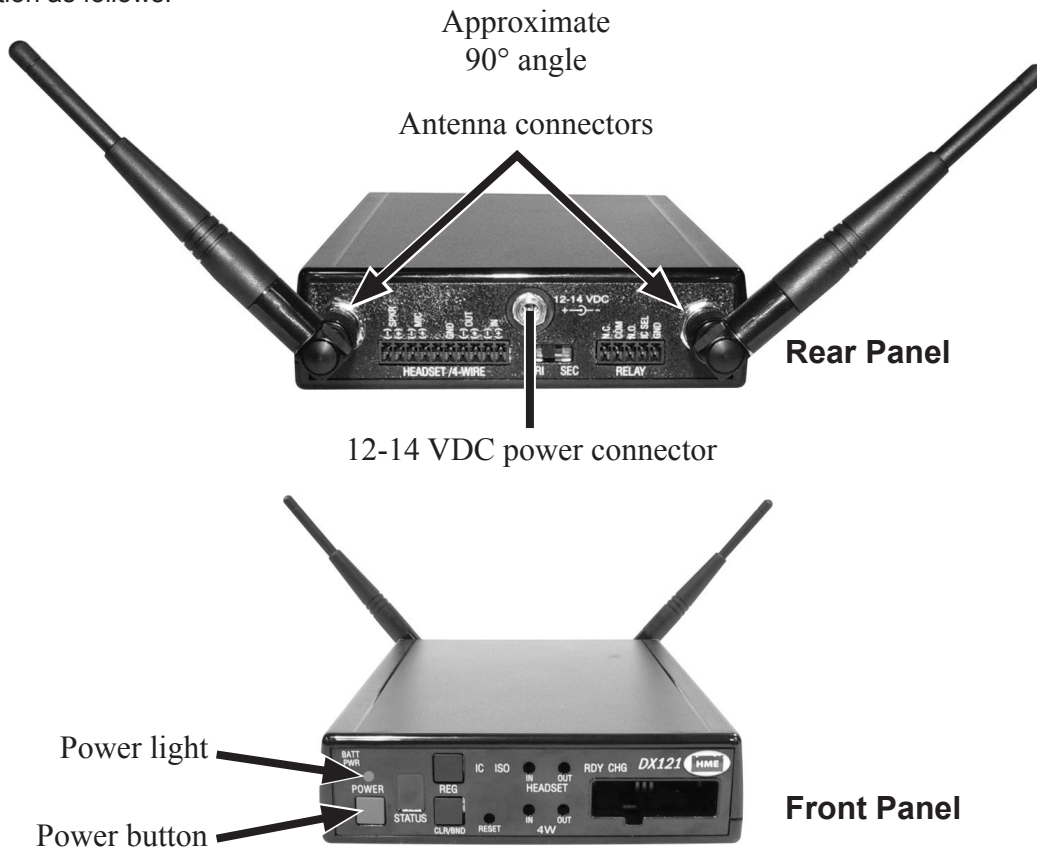

#### 1. Mount antennas -

Mount the two enclosed antennas on the antenna connectors on the rear panel of the Base Station. Position the antennas at an approximate **90°** angle. Turn the sleeve on each of the antenna connectors clockwise to tighten it securely in place.

#### 2. Connect power -

- Plug the connector at the end of the AC power supply cord into the **12-14VDC** power connector on the rear panel of the Base Station, and turn the nut on the connector clockwise to secure it to the Base Station.
- Plug the female connector at one end of the power cord into the AC power supply, and plug the other end into an electrical outlet.
- Press the **POWER** button on the front of the Base Station to turn it on. The red light above the button should turn on.

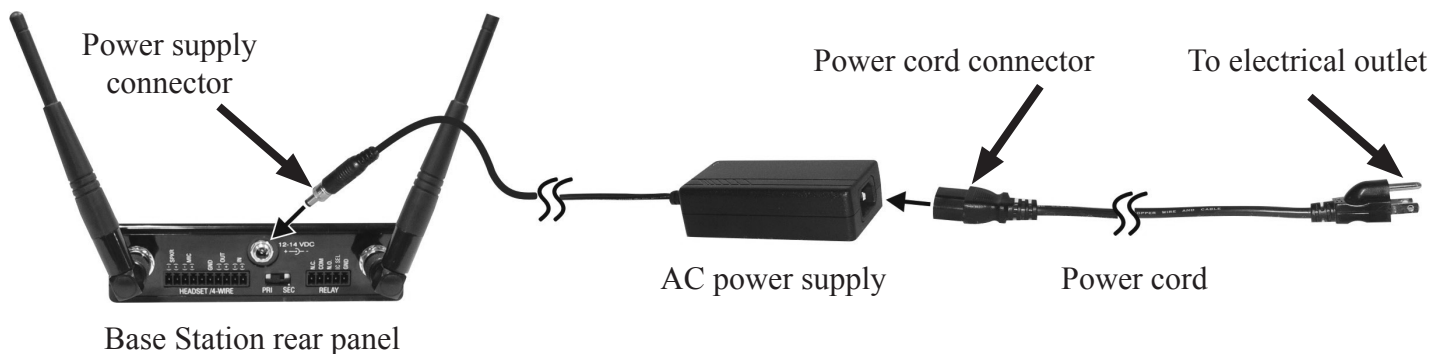

### 3. Charge batteries -

**IMPORTANT!** – Before using the DX121 system, charge the batteries for the Beltpacs and/or WH220 Headsets. Charging time for fully-discharged batteries is about 3 hours per battery.

- One battery can be charged in the battery charger at a time.
- Insert a battery in the charging port until it clicks in place.
- A red charging **CHG** light above the battery port stays on while a battery in the port is charging.
- A green ready **RDY** light above the battery port goes on when a battery in the port is fully charged.

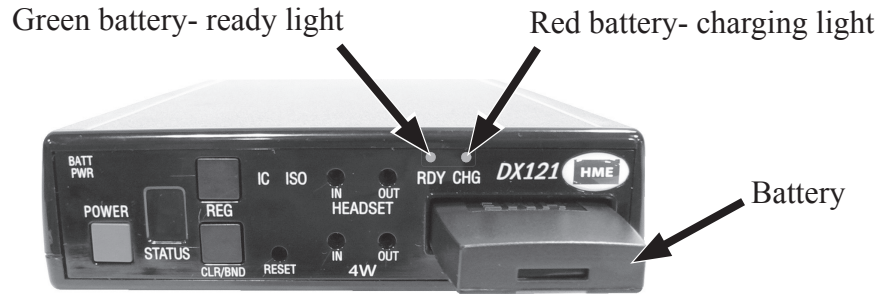

## AC50 Battery Charger Setup

The AC50 is the charger for All-in-One headsets.

Before installing the system, connect the AC power supply to the battery charger and plug it into an electrical outlet. Charge all the batteries while the other equipment is being installed. Charging time is about 2.5 hours.

### Connect AC Power Supply

To connect the AC power supply to the battery charger:

- Connect the AC power supply cable connector to the power connection on the battery charger.
- Connect the AC power cord to an electrical outlet.

The red lights on the charger will briefly display, and then the yellow lights will appear and remain on.

### Charging the Batteries

Up to four batteries can be charged in the battery charger at one time. The battery status lights next to each charging port indicate the battery status. Up to four fully charged batteries can be stored in the battery Storage ports. Insert a battery in each of four Charging ports until it clicks in place.

- A yellow light next to a Charging port indicates that the port is **EMPTY**.
- A red light next indicates that the battery port is **CHARGING**.
- A green light indicates that the battery is **READY**.
- A steady yellow light indicates that the **CHARGE FAILED**. If a charge fails, refer to the instructions on the side of battery charger.
- A flashing yellow light next indicates **CHARGE PENDING**, which means the inserted battery is too hot. Adjust the room temperature or move the charger to a cooler area.
- Store fully charged batteries in storage ports.

**IMPORTANT:** Batteries should not be left in charge ports after being fully charged. A battery left in a charging port for more than three weeks may display the yellow indicator light, but it does not indicate a faulty battery.

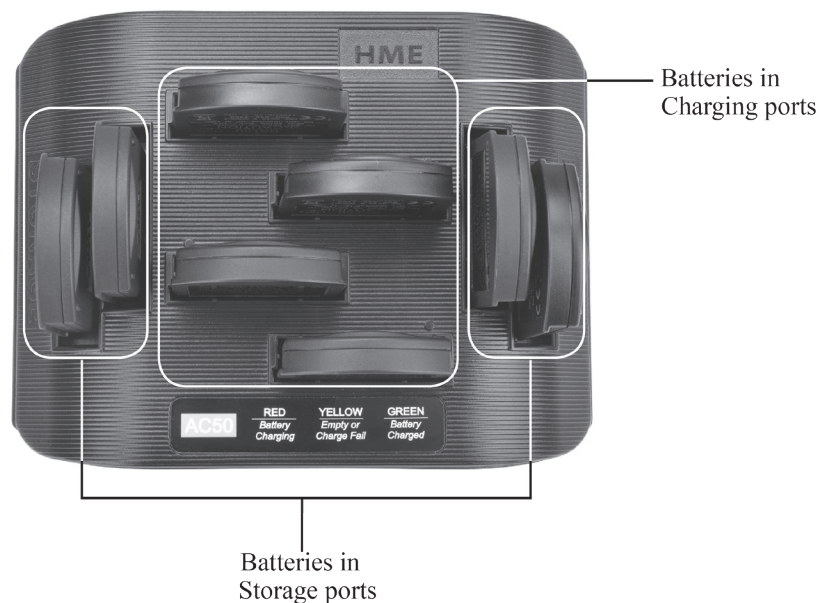

## Interference Avoidance

Interference, which may be heard in a headset as popping sounds, may occur whenever other equipment such as WI-FI systems, wireless DMX systems, other HME Base Stations are using the same frequency band. If these systems can be limited to one portion of the band, then the DX121 can be set to the opposite half of the 2.4 GHz to 2.48 GHz band. To avoid this type of interference, set up the base stations for “split-band” operation by selecting the upper part of the frequency range on one Base Station (or more) and the lower part of the frequency range on the other(s). Here’s how:

1. Turn on the Base Station power. An “8” will appear on the **STATUS** display for a few seconds.
2. Once the “8” disappears and the **STATUS** display is blank, press and hold the **CLR/BND** button.
3. While holding the **CLR/BND** button, press and hold the **REG** button and wait until a L, H or A appears, and then release both buttons.
4. Press the **CLR/BND** button to cycle through and select a frequency band: **L** = Low end, **H** = High end and **A** = All.
5. Wait until “c” appears on the display.



**NOTE:** Base stations are shipped in the **A** (default) position.

## Multiple Base Station Setup

This mode of operation can be used to expand the number of users communicating through multiple HME Base Stations operating in the same portion of the 2.4 GHz to 2.48 GHz frequency band.

### Primary and Secondary Base Station Settings

One Base Station must be designated as “Primary” while the others are designated as “Secondary”. You can have only one primary and up to 3 secondary Base Stations. Secondary Base Stations are assigned numbers 1, 2, or 3.

1. Label the Base Stations as **Primary, 1, 2** and **3**.
2. Start with every Base Station and beltpac/headset powered off.
3. Locate the **PRI SEC** switch on the rear panel of the Base Station.
4. Set the **PRI SEC** switch to the **PRI** position on the primary Base Station.
5. Set the **PRI SEC** switch to the **SEC** position on each secondary Base Station.
6. If a Base Station has been set for interference avoidance, it should be used as the primary Base Station. The secondary Base Stations will automatically be set to the same band when they are initialized.

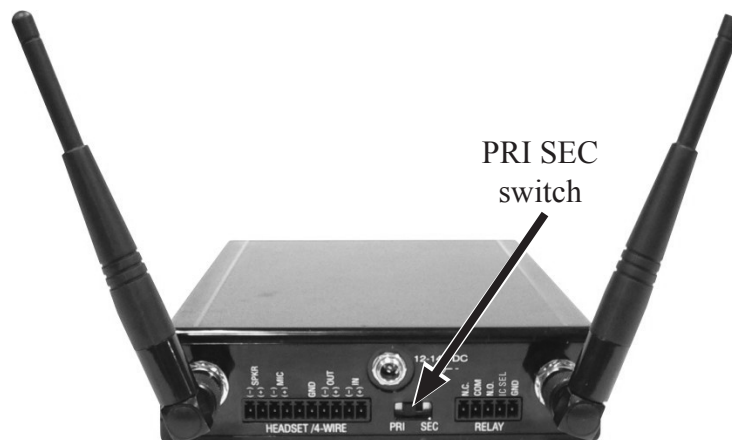

Rear panel of Base Station

## Base Station Initialization

For multiple HME Base Stations to operate without interference, they must be properly initialized before performing any other setups. After initializing each Base Station, register each beltpac or headset that will be used with that base according to the procedures on [pages 12 – 15](#).

**NOTE:** Base stations must be set up for split-band operation prior to initialization.

(See Interference Avoidance on [page 9](#).)

1. Turn the primary Base Station power on. Register any beltpac or headsets to be used with the primary Base Station (See [pages 12 – 15](#)). Turn each beltpac or headset off after registering it.
2. Power on one **secondary** Base Station. The **STATUS** display will show a double bar, indicating the secondary base is ready to be initialized.

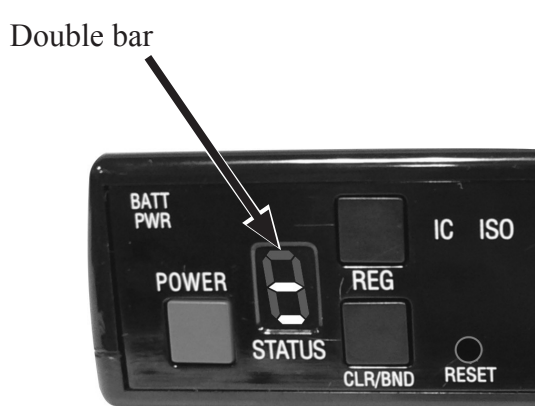

**Base Station ready to be initialized**

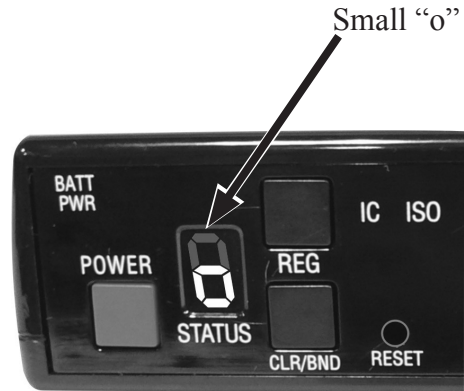

**Small "o" indicates primary base is open for registration**

3. Press the **REG** button on the primary base. The **STATUS** display will show a small "o".
4. To assign a number to a secondary Base Station and then initialize it, repeatedly press the **REG** button on the secondary base to cycle through the numbers **1, 2, and 3**. When the desired number appears, stop pressing and wait.
5. While the secondary base initializes to the displayed number, the **STATUS** display will continue showing the secondary number selected. When initialization of the secondary Base Station is finished, one bar is displayed that indicates that the secondary has initialized to the primary.

Secondary base number

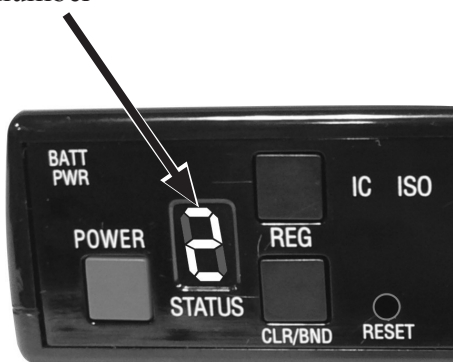

**Secondary 2 searching for primary**

One bar

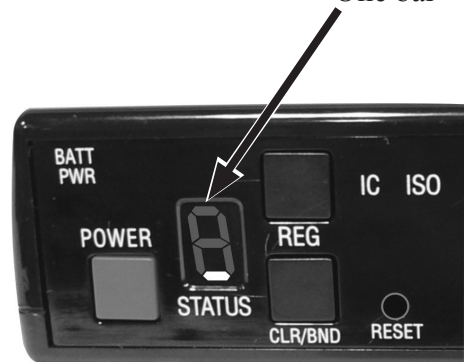

**Secondary is initialized to primary**

6. Press the **REG** button on the primary. The **STATUS** display will go blank.
7. Register beltpac or headsets to the secondary (See [pages 12 – 15](#)). After registration, turn off the secondary base and all Beltpac and headsets.

8. Repeat these steps for each remaining secondary base. Use a different number for each. Only the primary base and the secondary base you are working with should have power on during initialization. All other equipment should be off.
9. After all secondary bases are initialized with belt-pacs and headsets registered, power up all bases.
10. Press **RESET** on the primary base, and let it recover. Turn on the primary belt-pacs or headsets to allow them to link.
11. Press **RESET** on each secondary base (one at a time), and let it initialize to the primary (indicated by a single bar).
12. Turn on the belt-pacs or headsets associated with the secondary bases. Complete one group at a time until they have all linked, then move on the next group. At this point all bases and belt-pacs or headsets should be powered up and linked, ready for use.
13. Proceed with normal system configuration, setting functions and levels as required.

### Replacing a Secondary Base

Use the procedure above to initialize the new secondary with the same number as the old secondary. After initialization you will have to register any Belt-pacs/Headsets associated with the old secondary to the new secondary.

### Replacing a Primary Base

Follow the above procedure completely. Before initialization of the secondary bases, clear the previous secondary initialization as follows:

For each secondary, press the **CLR/BND** button and the **RESET** button simultaneously. Continue holding the **CLR/BND** button while releasing the **RESET** button until the clear code ("c") appears on the **STATUS** display. Any belt-pacs or headsets associated with the old primary will have to be registered to the new primary after secondary base initialization. Also, all belt-pacs and headsets associated with secondary Base Stations must be registered again.

### Primary Base is Shut Down or Powered Off for More than 30 Seconds

All secondary bases will drop their belt-pac and headset connections and begin searching for the primary. If the primary is not found in 30 seconds, the secondary will automatically revert to primary-mode operation and reconnect the belt-pacs or headsets.

At this point, the secondary **STATUS** displays will show three bars. If the primary powered on, it will be necessary to press **RESET** on all secondary bases to allow them to find and initialize to the primary again. It's important to have all bases connected to the same AC circuit to prevent this situation when the system is shut down after hours and powered up again the next day.

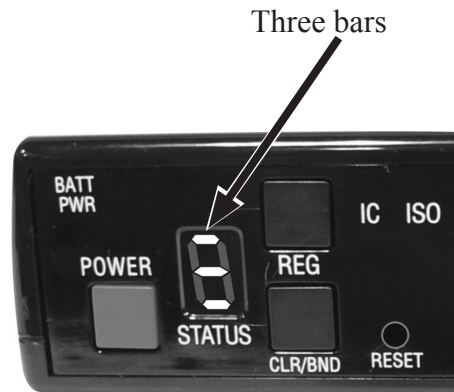

**Secondary base operating in primary mode when no primary base is found**

**NOTE:** You cannot register belt-pacs and headsets to a base that is set to primary mode, and then switch the base mode to secondary for initialization. Once in secondary mode, the base cannot recognize the belt-pacs and headsets registered during primary operation. For secondary bases, the belt-pacs and headsets must always be registered after secondary base initialization, with the primary base remaining active and the secondary base displaying one bar.



# Belpac / All-In-One Headset Setup and Registration

The first time you operate the DX121 system, you must register each BP200 Belpac and/or WH220 All-In-One Headset for use with a specific Base Station. The Base Station will then recognize all registered belpacs and headsets when their power is on and differentiate between them and other electronic equipment operating on the same frequencies. If a belpac or headset is added, replaced or repaired later, the new one must be registered and the replaced one remains in memory. A maximum of 4 belpacs and headsets can be registered to a single Base Station at one time. If the maximum number of 4 is exceeded, you must clear all current registrations and re-register all active belpacs and headsets.

**NOTE:** The following two pages are for Belpac setup and registration. All-In-One Headset setup and registration instructions are on [pages 14 and 15](#).

## Set Up Belpacs

Before registering them, set up all Belpacs as follows:

1. Insert a fully charged battery in the Belpac, with the metal contacts on the end of the battery inserted first. Press it in until it snaps.
2. Place the Belpac in the pouch.
3. Plug the headset cable connector into the Belpac.



## Register Belpacs

Belpacs must be within 6 feet (1.83 meters) of the Base Station during registration. Before you begin, be certain the Base Station power is on and each Belpac to be registered is turned off. Registered Belpacs can be on or off.

**NOTE:** If you are setting up multiple Base Stations, the following steps must be repeated for Belpacs being registered to each Base Station.

1. Place the headset of the Belpac being registered on your head.
2. Press the **REG** button on the front panel of the Base Station (#6 on Base Station front panel illustration).
  - The **STATUS** display (#4 on Base Station front panel illustration) will show a small "o" for open.
3. Press and hold the **ISO** button on the Belpac while you press and release the **PWR** (power) button to turn the unit on, then release the **ISO** button. This will cause the Belpac to enter the registration mode.
  - The two power lights at the corners of the Belpac near the **IC** and **ISO** buttons will blink red, then blink green two or three times and turn off.
  - Wait! There may be a short delay.

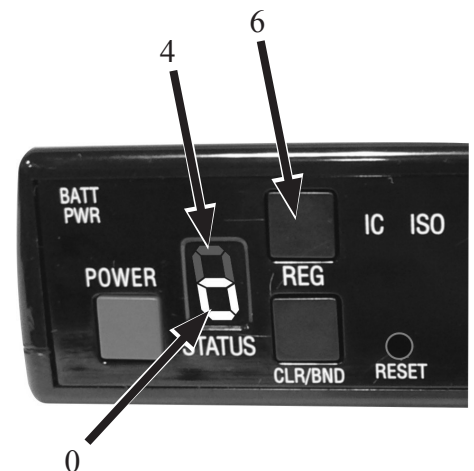

### If registration is successfully completed:

- A voice message in the headset will say “Power on, Beltpac #, Version #, Begin registration, Registration complete, ...”
- After a delay of up to 15 seconds, the **STATUS** display will show the ID number assigned to this Beltpac for about 10 seconds.

**NOTE:** ID numbers are assigned sequentially as 0 through 3.

- The power light on the Beltpac, next to the **IC** button, will remain on steady green.
- **Repeat Steps 1 to 3 at the bottom of [page 12](#) for each Beltpac to be registered.**

### If registration failed:

- A voice message in the headset will say “Power on, Beltpac #, Version #, Begin registration, ...” Both power lights on the Beltpac will be blinking red, and there may be a delay of up to 90 seconds before you hear “Registration failed” and the **STATUS** display (#4) goes blank.
- Press **RESET** (#7) on the Base Station. To press **RESET**, insert a small paper clip or similar object into the **RESET** hole at the lower-left corner of the Base Station front panel. When the **STATUS** display (#4) becomes blank, press the **REG** button (#6) and register the Beltpac again. If registration fails again, call your dealer for assistance.

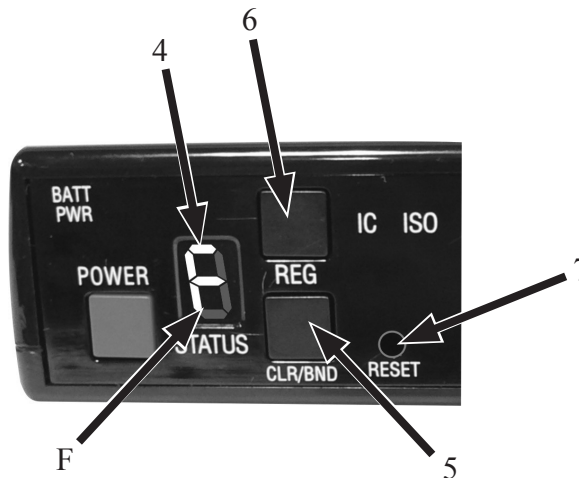

### If you try to register more than 4 devices (combination of beltpacs or headsets) to a Base Station:

- An “F” (for registration “Full”) will appear on the **STATUS** display (#4) on the Base Station and you will hear “Registration failed” in the Headset.
- Clear all current registrations by pressing the **CLR/BND** button (#5) and **RESET** (#7) simultaneously. To press **RESET**, insert a small paper clip or similar object into the **RESET** hole at the lower-left corner of the Base Station front panel. Continue holding the **CLR/BND** button after you release **RESET**, until the clear code “c” (lower case) appears on the **STATUS** display.
- Register all active Beltpacs, one at a time.

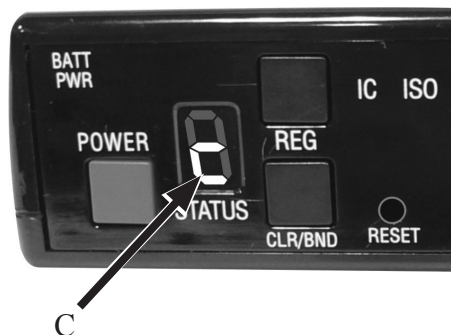

## Set Up All-In-One Headsets

Before registering them, insert a fully charged battery in each Headset. When a battery weakens, you will hear “Change battery”. At this time, remove the battery from the headset by pressing the blue battery-release latch to remove the battery.

### Power On/Off

- **To turn power on**  
Press and release the power button on the inside of the Headset housing. A voice message in the earpiece will say “Headset #” and the power light on the opposite side of the earpiece will turn on.
- **To turn power off**  
Press and hold the power button for approximately 3 seconds. A voice message in the earpiece will say “Headset off”, and the power light on the opposite side of the earpiece will go off.

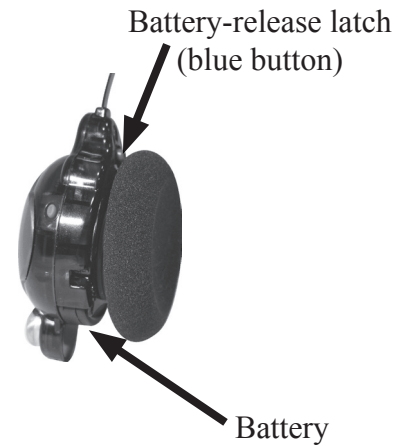

## Register All-In-One Headsets

Headsets must be within 6 feet (1.83 meters) of the Base Station while you are registering them. Be certain the Base Station power is on, and each Headset you are going to register is turned off before you begin. Headsets that are already registered can be on or off.

**NOTE:** If you are setting up multiple Base Stations, the following steps must be repeated for Headsets being registered to each Base Station.

1. Put the Headset on your head.
2. Press the **REG** button on the front panel of the Base Station (#6 on Base Station front panel illustration).
  - The **STATUS** display (#4 on Base Station front panel illustration) will show a small “o” for open.

**NOTE:** If you wait too long before moving to Step 3, the Base Station will exit registration mode and you will have to repeat Step 2.

3. Press and hold the **ISO** button on the Headset while you press and release the power button to turn the unit on, then release the **ISO** button. This will cause the Headset to enter registration mode.
  - The Headset power light will begin blinking red, then will blink green two or three times and go off. There may be a short delay.

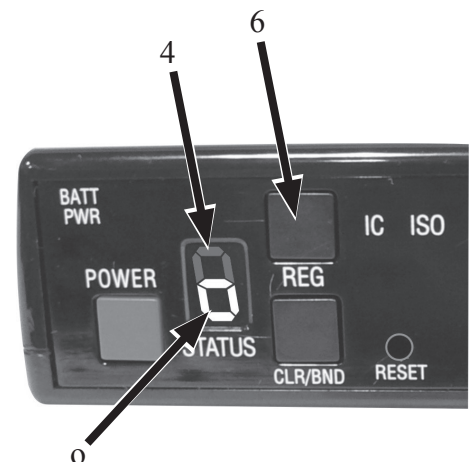

### If the registration is successfully completed:

- A voice message in the Headset will say “Power on, Headset #, Version #, Begin registration, Registration complete, ...”
- After a delay of up to 15 seconds, the **STATUS** display will show the ID number assigned to this Headset for about 10 seconds.  
**NOTE:** ID numbers are assigned sequentially as 0 through 3.
- The power light on the Headset will remain on steady green.
- **Repeat Steps 1 to 3 at the bottom of page 14 for each Headset to be registered.**

### If registration failed:

- A voice message in the Headset will say “Power on, Headset #, Version #, Begin registration, ...”. The power light on the Headset will be blinking red, and there may be a delay of up to 90 seconds before you hear “Registration failed” and the **STATUS** display (#4) goes blank.
- Press **RESET** (#7) on the Base Station. To press **RESET**, insert a small paper clip or similar object into the **RESET** hole at the lower-left corner of the Base Station front panel. When the **STATUS** display (#4) becomes blank, press the **REG** button (#6) and register the Headset again. If registration fails again, call your dealer for assistance.

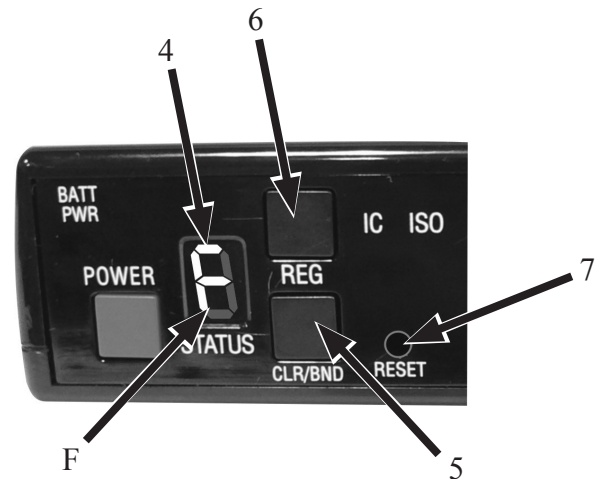

### If you try to register more than 4 devices (combination of belt-pacs or headsets) to a Base Station:

- An “F” (for registration “Full”) will appear on the **STATUS** display (#4) on the Base Station and you will hear “Registration failed” in the Headset.
- Clear all current registrations by pressing the **CLR/BND** button (#5) and **RESET** (#7) simultaneously. To press **RESET**, insert a small paper clip or similar object into the **RESET** hole at the lower-left corner of the Base Station front panel. Continue holding the **CLR/BND** button after you release **RESET**, until the clear code “c” (lower case) appears on the **STATUS** display.
- Register all active WH220 Headsets, one at a time.

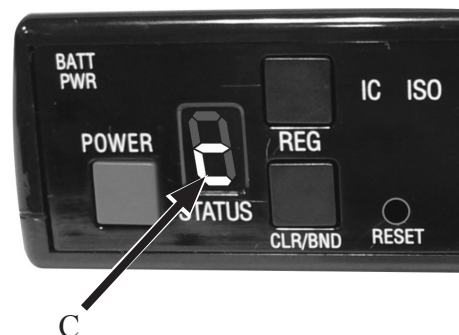

### NOTICE

You have completed the system setup.

The instructions under [INTERCOM AND RELAY CONNECTIONS](#) on the next page are for setting up auxiliary audio equipment which you may want to use with your DX121.

# Intercom and Relay Connections

If using your DX121 with a wired intercom system, connect the intercom to the **HEADSET/4-WIRE** connector on the rear panel of the Base Station as shown below. Also, the **RELAY** connector shown below can be used as a “dry contact” for any outside equipment.

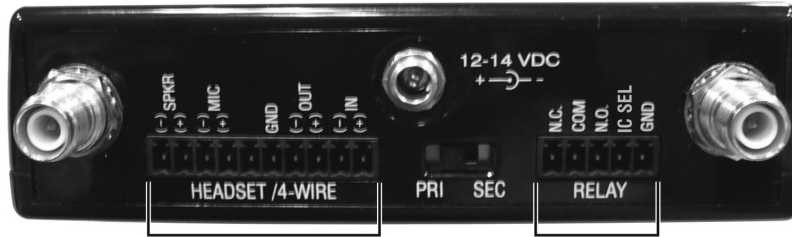

Base Station rear panel showing HEADSET/4-WIRE and RELAY connectors

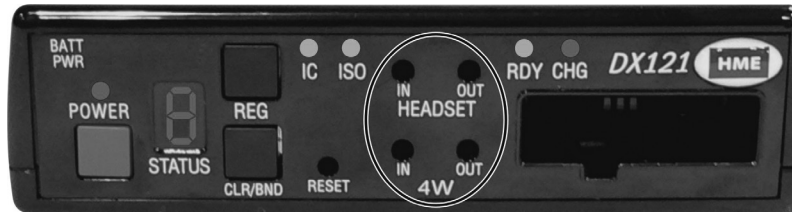

Base Station front panel showing HEADSET and 4W (4-Wire) input and output level adjustments

HEADSET/4-WIRE Connector		
Pin 1	Headset connections	SPKR – Input
Pin 2		SPKR + Input
Pin 3		MIC – Output
Pin 4		MIC + Output
Pin 5	4-Wire connections	N/C
Pin 6		GND
Pin 7		4-WIRE – Output
Pin 8		4-WIRE + Output
Pin 9		4-WIRE – Input
Pin 10		4-WIRE + Input

**NOTE:** Indicated PinOut connections should be matched to the corresponding PinOut connections of the intercom which will be used.

RELAY Connector	
Pin 1	N.C. (Normally Closed)
Pin 2	COM
Pin 3	N.O. (Normally Open)
Pin 4	IC SEL
Pin 5	GND

## Intercom Headset Connection

If using the headset connector of an intercom, connect the wires from a headset connector (not provided) to pins 1 through 4 of the **HEADSET/4-WIRE** connector on the rear panel of the Base Station. Be sure the headset jack of the intercom system is turned on. For intercom headset wiring diagram, see [page 28](#).

## 4-Wire Intercom Connection

If using a 4-Wire intercom, connect the wires from a 4-Wire connector into the **HEADSET/4-WIRE** connector on the rear panel of the Base Station. For 4-Wire wiring diagram, see [page 28](#).

## Relay Operation

In the default mode, the relay will operate only when the **ISO** button is pressed. In the **IC SEL** mode, the relay will operate only when the **IC** button is pressed. With either mode, the **IC** button activates audio to the **HEADSET/4-Wire IN/OUT** connector. The **IC SEL** mode is selected by placing a jumper across pins 4 and 5 of the **RELAY** connector.

## SECTION 3. EQUIPMENT OPERATION

### Base Station Operation

#### Front Panel Controls, Indicators and Connector

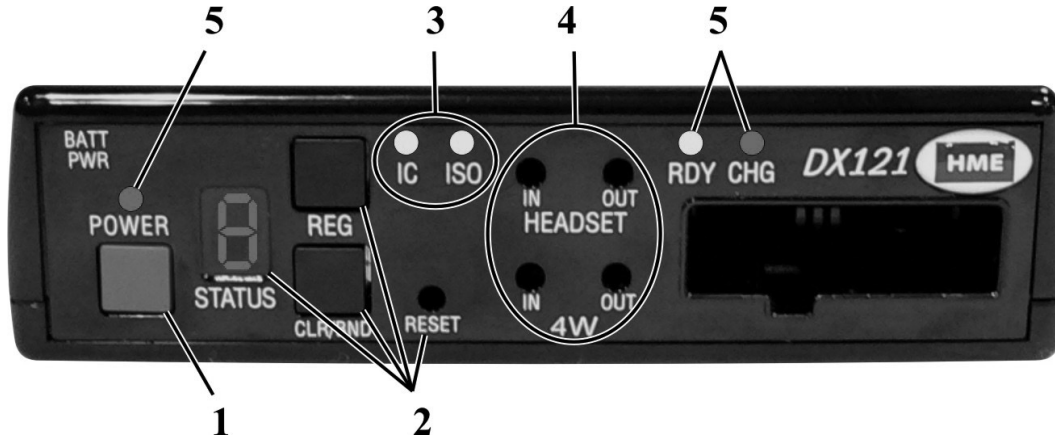

#### 1. Power button

Press the **POWER** button to turn the power on. A red light above the button will be lit when the Base Station power is on. Press the button again to turn the power off. The light will go off. All settings are preserved when the power is turned off, and will be restored when the power is turned on again.

#### 2. Registration Controls and Status Indicator

Use these controls to register each Beltpac, All-In-One Headset and/or Speaker Station beltpac or headset used with a specific Base Station.

**STATUS** display – the status of belt-pacs and headsets as they are being registered to the Base Station

**REG** button – is used to set the Base Station in registration mode, so registration can begin

**CLR/BND** button / **RESET** switch – when used together, clear all registrations from the Base Station

#### 3. IC (Intercom) and ISO (Isolate) Receiver Indicators and Controls

Green lights indicate whether **IC** or **ISO** is being received.

#### 4. Adjustments

Use a screwdriver to adjust the **HEADSET** and **4W IN** (input) and **OUT** (output) levels.

#### 5. Indicators

**POWER** – When the DC power is on, the red **POWER** light will be lit.

**CHG** – When the battery is charging, the red **CHG** light will be lit.

**RDY** – When the battery is fully charged, the green **RDY** light will be lit.

# Belpac Operation

The Belpac control buttons have a snap action. They will activate when pressed firmly. Use your fingertips, not your fingernails, to press the buttons.

## Power On/Off

- **Power On** — Press and release the **PWR** (power) button.  
A voice message in the earpiece will say “Power on, Belpac #, Version #”, and the red power lights at the corners of the **IC** and **ISO** buttons will turn on. After a short time, one light will go off and the other will change to green indicating the Belpac is ready for use. The **STATUS** indicator on the Base Station will momentarily indicate the ID of the Belpac.
- **Power Off** — Press and hold the **PWR** button for approximately 2 seconds.  
A voice message in the earpiece will say “Power off”, and the green power light will turn off.

**NOTE:** While the Belpac is transmitting, the green power light will be flashing. The green power light will be on steady whenever the Belpac is ready, but not transmitting.



## ISO and IC

Either the **ISO** or **IC** button can be used to talk to other belpacs and headsets. **IC** will send the audio signal out to intercoms through the **HEADSET** and **4-WIRE** connections on the rear panel of the Base Station. Depending on your Base Station **RELAY** operation setup (see [page 16](#)), either the **ISO** button or the **IC** button will activate any outside equipment connected to the **RELAY** connector on the rear panel of the Base Station.

- **Push-To-Talk Mode** — To set the Belpac for push-to-talk (PTT) communication, with the power off, press and hold the volume-down ▼ and **ISO** buttons while you press and release the **PWR** (power) button. You will hear “Power on, Belpac #, Version #, Hands-free off” in the headset. Press and hold the **IC** or **ISO** button while talking.
- **Hands-free Mode** — To set the Belpac for hands-free communication, with the power off, press and hold the volume-up ▲ and **ISO** buttons while you press and release the **PWR** (power) button. You will hear “Power on, Belpac #, Version #, Hands-free on” in your headset. When set up for hands-free communication, the Belpac can be operated in either hands-free or PTT.
- **ISO Lockout Mode** — To set the Belpac with the ISO feature locked out, with the power off, press and hold the **IC** button while you press and release the **PWR** (power) button. You will hear “Power on, Belpac #, Version #, ISO off” in your headset. When set up for the ISO Lockout mode, the **ISO** button will operate the same as the **IC** button, in either hands-free or PTT communication.

To reset the ISO feature for normal **ISO** button communication, with the power off, press and hold the **ISO** and **IC** buttons while you press and release the **PWR** (power) button. You will hear “Power on, Belpac #, Version #, ISO on” in your headset.

**NOTE:** The above settings are saved in memory and only need to be repeated when you want to change between hands-free and PTT operation. When changing modes, if both power lights begin blinking, turn the Belpac off and begin again. Hands-free and Push-To-Talk mode settings affect both **IC** and **ISO**. Individual adjustment is not possible.

- **Push-To-Talk Mode Operation** — Press and hold the **IC** or **ISO** button while speaking. In PTT operation, audio will be transmitted only while you are pressing the **IC** or **ISO** button.
- **Hands-free Mode Operation** — Quickly press and release the **IC** or **ISO** button to “latch” the transmitter on in the hands-free mode. Talk and listen, as in a normal telephone conversation. Press and release the **IC** or **ISO** button again to “unlatch”, to end the conversation. If either button is held down for more than a half second, the Belpac will function as PTT.

**NOTE:** In hands-free mode, pressing the **IC** button while latched in **ISO** will latch on **IC**. Pressing the **ISO** button while latched in **IC** will latch on **ISO**.

## Volume Up/Down

- **Volume Up Adjustment** — Each time you press and release the volume-up ▲ button, you will hear a higher pitch beep in the earpiece as the volume increases one step. If you press and hold the volume-up button, you will hear beeps of ascending pitch as the volume steps up to maximum. When maximum volume is reached, you will hear “maximum” repeating until you release the volume-up button.
- **Volume Down Adjustment** — Each time you press and release the volume-down ▼ button, you will hear a lower pitch beep in the earpiece as the volume decreases one step. If you press and hold the volume-down button, you will hear beeps of descending pitch as the volume steps down to minimum. When minimum volume is reached, you will hear rapidly repeating beeps until you release the volume-down button.

## Sidetone Adjustment

To adjust sidetone (the volume level of your own voice heard in the headset as you speak into the microphone), press and hold the **IC** button while you press the volume-up ▲ or volume-down ▼ button.

If you reach the maximum volume level, you will hear “Maximum” in the headset. If you reach the minimum volume level you will hear double beeps. Your sidetone setting will be saved in memory, and does not require readjustment each time the Beltpac is turned off and on.

**NOTE:** This adjustment only affects the level of your voice in your own headset, not how anyone else hears you.

## Microphone Gain Adjustment

Some users talk louder or softer than others. To allow for this, microphone gain adjustment is provided.

**To increase microphone gain** — Press the volume-up ▲ button while holding down the **ISO** button in the normal operating mode. The microphone gain increase can be monitored through sidetone, or preferably by someone else or at the Base Station.

**To decrease microphone gain** — Press the volume-down ▼ button while holding down the **ISO** button in the normal operating mode. The microphone gain decrease can be monitored through sidetone, or preferably by someone else or at the Base Station.

**NOTE:** You will hear “Maximum” if you attempt to go higher than maximum microphone gain. You will hear beeps if you attempt to go lower than minimum microphone gain. Microphone gain will be saved in non-volatile memory and does not require readjustment each time the power is turned on.

## Change Batteries

When a battery becomes weak, a voice in the earpiece will say “Change battery”. When this happens, take the Beltpac out of its pouch and remove its battery. Slide the arrow-shaped battery-release latch in the direction of the arrow. Pull up on the end of the battery near the battery-release latch and lift the battery out of the Beltpac, or turn the Beltpac over and catch the battery in your hand.

When replacing a battery in the Beltpac, place the end of the battery with the metal contacts into the battery holder on the Beltpac, in the same position as the battery you removed. Press the top of the battery carefully into the battery holder until it snaps in place under the battery-release latch. Recharge batteries according to the instructions on page 8.

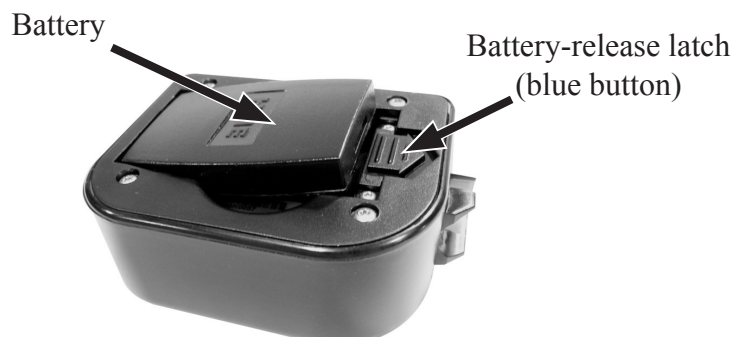



# All-In-One Headset Operation

The Headset control buttons will activate when pressed lightly. Use your fingertips, not your fingernails, to press the buttons.

## Power On/Off

- **Power On** — Press and release the power button on the inside of the Headset housing. A voice message in the earpiece will say “Power on, Headset #, Version #” and the power light will turn on. The **STATUS** indicator on the Base Station will momentarily indicate the Headset ID number.
- **Power Off** — Press and hold the power button for approximately 3 seconds. A voice message in the earpiece will say “Power off”, and the power light will go off.

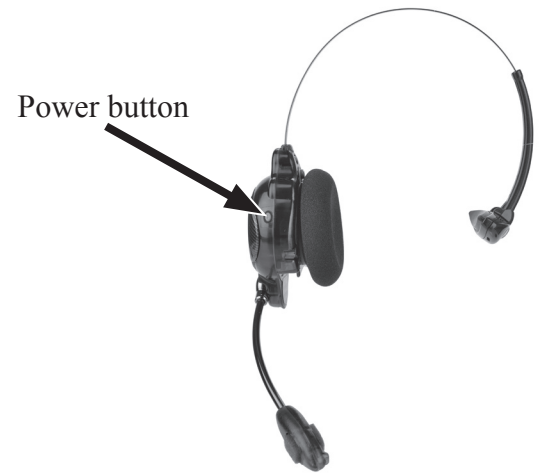

## ISO and IC

The **ISO**, **IC1** or **IC2** buttons can be used to talk to others. IC will send the audio signal out to intercoms through the **HEADSET** and **4-WIRE** connections on the rear panel of the Base Station.

Depending on your Base Station **RELAY** connection setup (see [page 17](#)), either the **ISO** button or the **IC** button will activate any outside equipment connected to the **RELAY** connector on the rear panel of the Base Station.

- **Push-To-Talk Mode** — To set the Headset for Push-To-Talk (PTT) communication, with the power off, press and hold the volume-down ▼ and **ISO** buttons while you press and release the power button. You will hear “Power on, Headset #, Version #, Hands-Free off” in the earpiece. Press and hold the **IC1**, **IC2** or **ISO** button while talking.
- **Hands-Free Mode** — To set the Headset for Hands-Free (HF) communication, with the power off, press and hold the volume-up ▲ and **ISO** buttons while you press and release the power button. You will hear “Power on, Headset #, Version #, Hands-Free on” in the earpiece. When set up for Hands-Free communication, the Headset can be operated in either HF or PTT.
- **ISO Lockout Mode** — To set the Headset with the ISO feature locked out, with the power off, press and hold the **IC1** button while you press and release the power button. You will hear “Power on, Headset #, Version #, ISO off” in your Headset. When set up for the ISO Lockout mode, the **ISO** button will operate the same as the **IC1** button, in either hands-free or PTT communication. To reset the ISO feature for normal **ISO** button communication, with the power off, press and hold the **ISO** and **IC1** buttons while you press and release the power button. You will hear “Power on, Headset #, Version #, ISO on” in your Headset.
- **Lights-off Mode** — To prevent the power and transmit lights from coming on during headset operation, press and hold the **IC2** button while you press the power button to turn the headset on. To return the lights to their normal functions, turn the power off and on again without pressing the **IC2** button.



**NOTE:** The above settings are saved in memory and only need to be repeated when you want to change between HF and PTT operation. When changing modes, if both power lights begin blinking, turn the Headset off and begin again. Hands-Free and Push-To-Talk mode settings affect both IC and ISO. Individual adjustment is not possible.

- **Push-To-Talk Mode Operation** — Press and hold the **IC1**, **IC2** or **ISO** button while speaking. In PTT operation, audio will be transmitted only while you are pressing the **IC1**, **IC2** or **ISO** button.
- **Hands-Free Mode Operation** — Quickly press and release the **IC** or **ISO** button to “latch” the transmitter on in the HF mode. Talk and listen, as in a normal telephone conversation. Press and release the **IC** or **ISO** button again to “unlatch”, to end the conversation. If either button is held down for more than a half second, the Headset will function as PTT.

**NOTE:** In Hands-Free mode, pressing the **IC1** or **IC2** button while latched in ISO will latch on IC. Pressing the **ISO** button while latched in IC will latch on ISO.

## Volume Up/Down

- **Volume Up Adjustment** — Each time you press and release the volume-up ▲ button, you will hear a higher pitch beep in the earpiece as the volume increases one step. If you press and hold the volume-up button, you will hear beeps of ascending pitch as the volume steps up to maximum. When maximum volume is reached, you will hear “maximum” repeating until you release the volume-up button.
- **Volume Down Adjustment** — Each time you press and release the volume-down ▼ button, you will hear a lower pitch beep in the earpiece as the volume decreases one step. If you press and hold the volume-down button, you will hear beeps of descending pitch as the volume steps down to minimum. When minimum volume is reached, you will hear rapidly repeating beeps until you release the volume-down button.

## Microphone Gain Adjustment

Some users talk louder or softer than others. To allow for this, microphone gain adjustment is provided.

**To increase microphone gain** — Press the volume-up ▲ button while holding down the **ISO** button in the normal operating mode. The microphone gain increase can be monitored through sidetone, or preferably by someone else or at the Base Station.

**To Decrease microphone gain** — Press the volume-down ▼ button while holding down the **ISO** button in the normal operating mode. The microphone gain decrease can be monitored through sidetone, or preferably by someone else or at the Base Station.

**NOTE:** You will hear “Maximum” if you attempt to go higher than maximum microphone gain. You will hear two beeps if you attempt to go lower than minimum microphone gain. Microphone gain will be saved in non-volatile memory and does not require readjustment each time the power is turned on.

## Change Batteries

When a battery becomes weak, a voice in the Headset will say “Change battery”. When this happens, remove the battery from the headset by carefully sliding the battery-release latch and lifting the battery out.

When replacing a battery in the Headset, place the end of the battery with the metal contacts into the battery holder on the Headset, in the same position as the battery you removed. Press the top of the battery carefully into the battery holder until it snaps in place under the battery-release latch.

Recharge batteries according to the instructions on [page 8](#).

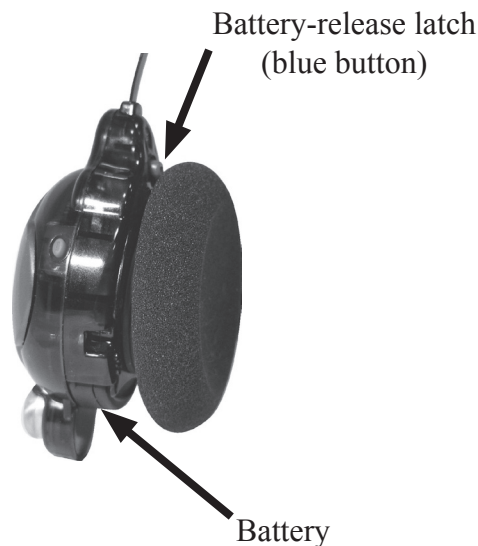

## SECTION 4. TROUBLESHOOTING

If you are unable to correct any of the problems described below, contact your dealer for assistance.

PROBLEM	SOLUTION
Power light on Base Station does not come on.	Be certain power cords are properly connected to Base Station, power supply and electrical outlet.
Beltpac or headset power lights do not turn green, and “out of range” is heard.	Be certain your Base Station power is on. Turn Beltpac or headset and Base Station power on and off. You may be too far from the Base Station. The range varies with each location’s layout.
When trying to register, it keeps saying registration failed.	Check to be sure that the STATUS window only goes blank, and does not show a registration number. Follow the instructions on clearing the registrations as found on page <a href="#">13</a> or <a href="#">15</a> , and repeat the registration procedure.
Others cannot hear me when I talk.	If you are using a Beltpac or local headset, be certain the headset connector is correctly plugged in to the Beltpac or Base Station.
People on the 4-Wire intercom cannot hear me or I cannot hear them.	Be certain the cables are securely connected and the 4-Wire intercom is on.
People on the RTS/ClearCom systems cannot hear me or I cannot hear them.	Be certain the cables are securely connected and the 2-wire intercom is on.

**2400MHz cordless telephone interference** — If there is a 2400MHz cordless telephone nearby, interference may occur. However, because the DX121 is a frequency-hopping system, this problem is unlikely. If it does occur, changing frequencies on the telephone may alleviate the problem. If not, move the phone as far as practical from the Base Station, or use another type phone.

**In the event of an electrical power outage** — such as from a lightning storm or power generator failure, if you experience problems with your HME equipment after the electricity comes on again, unplug the AC power supplies from their electrical outlets and wait 15 seconds, then plug them back in.

## SECTION 5. DX SERIES LED AID

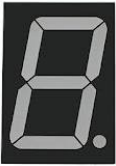

Powering on any DX base station will produce on the LED display the number “8” for approximately 3 seconds.



Blank display indicates the base is ready for operation.

**You can register belt packs under this condition.**



Single horizontal bar indicates the base is in secondary mode and registering to a base has been initiated and successfully linked with a primary base. **You can register belt packs in this mode.**



Two horizontal bars indicate that the base is in secondary mode and ready to be synced with a primary base. **You cannot register belt packs in this mode you must sync to a primary base first.**



Three horizontal bars indicate the base is in secondary mode and has been linked with a primary base but the primary base is **no longer** available to the secondary. It takes a few seconds for the secondary to recognize that the primary is not available and revert to a primary state. **However, you can register belt packs under this condition.**

### Syncing Secondary to Primary Bases Feature

To sync the bases, perform the following steps:

- Press the **REG** or **REGISTER BELT-PAC\*** button on the primary base and then press the **REG** or **REGISTER BELT-PAC\*** button on the secondary base to begin the sync process.
- As you repeatedly press the **REG** or **REGISTER BELT-PAC\*** button on the secondary you will see the numbers 1, 2, and 3 cycle through on the display. The numbers indicate the three available quadrants. **Note: The primary is in the 0 quadrant by default.**
- To select a quadrant, simply release the button at a desired number and wait. If successful, you will briefly see a blank display followed by a single horizontal bar in the secondary LED display. For additional secondary bases, assign each base to its own quadrant. Refer to the appropriate equipment manual for primary to secondary conversion.

After the bases are synced when the secondary is powered up the number “8” will appear followed by one of the numbers below on the secondary base LED display:



The number “1” indicates the quadrant the secondary has been placed in.



The number “2” indicates the quadrant the secondary has been placed in.



The number “3” indicates the quadrant the secondary has been placed in.

#### NOTE

\* Button has the same function but with a different description on the equipment due to vintage.



The lower case “c” will appear when the registry on the base station is cleared. To clear the registry power down the base. Hold down the **CLR/BND** or **RESET REGISTRATION\*** button first and then power the base on when you see the “8” on the LED display release the **CLR/BND** or **RESET REGISTRATION\***. If done successfully you will see a small "c" on the LED display.

**NOTE: The display indicates that the registry of a base station has been cleared of all belt pacs and secondary base stations that were registered to the base station.**

Another method to clear the registry would be to start by holding down the **CLR/BND** or **RESET REGISTRATION\*** button first and then pressing the **RESET** button until you hear a small click and then release the **CLR/BND** or **RESET REGISTRATION\*** button. If done successfully you will see a small "c" on the LED display. We recommend you use a very small paper clip.



The lower case “o” will appear when the **REG** or **REGISTER BELT-PAC\*** button is pressed and indicates that the base is ready to register a belt pac.

When registering belt pacs on DX bases that can carry 15 belt pacs please note that the numeric count displayed on the LED will be in hexadecimal. This means that the LED will represent the first 10 belt pacs as 0 to 9. Belt pac 11 will be represented by the letter A, belt pac 12 will be represented by the letter B and on up to belt pac 15 as E. Please see below.

Beltpac and Headset	1	2	3	4	5	6	7	8	9	10	11	12	13	14	15
Registry	0	1	2	3	4	5	6	7	8	9	A	B	C	D	E



The letter “F” will appear when the base registry is at its maximum of 15 registered belt packs. You will need to clear the registry to add a belt pac. To clear the registry power down the base. Hold down the **CLR/BND** or **RESET REGISTRATION\*** button first and then power the base on when you see the “8” on the LED display release the **CLR/BND** or **RESET REGISTRATION\***. If done successfully you will see a small "c" on the LED display.

## Spectrum Friendly Feature

**Spectrum Friendly option:** Hold down the **CLR/BND** (or **RESET REGISTRATION\***) button first then press and hold down the **REG** (or **REGISTER BELTPAC\***) button till you see the letter “A” or “L” or “H”. Then release both buttons and quickly press the **CLR/BND** (or **RESET REGISTRATION\***) to cycle through the “A” or “L” or “H”. options. Stop at your selection and wait for the LED display to go blank and a lower case c will appear on the status LED.

After this procedure is performed all bases, belt pacs and headsets will need to be re-registered to the base.

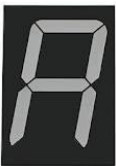

2400 to 2483.5 MHz is the operating frequency range.



2401.92 to 2439.94 MHz is the operating frequency range.

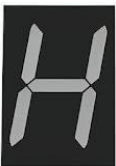

2443.39 to 2481.41 MHz is the operating frequency range.

### NOTE

\* Button has the same function but with a different description on the equipment due to vintage.

# SECTION 6. TECHNICAL DATA

## DX121 Equipment Specifications

### BS121 Base Station

#### GENERAL

Frequency Range	All, 2400 to 2483.5 MHz Low, 2401.92 to 2439.94 MHz High, 2443.39 to 2481.41 MHz
Frequency Response	200 Hz to 3.5 kHz
Power Requirements	100-240VAC, 50-60Hz or 12-14VDC
Temperature Range	32-122°F (0-50°C)
Size	1.62" x 5.50" x 7.88" (4.1 x 14 x 20 cm)
Weight	1.2 lbs. (.59 kg) with battery
# of Beltpacs per Base	4 can be registered Only 1 can have full-duplex communication at a time
4-Wire I/O	600Ω balanced, level adjustable, simultaneous operation with headset
Headset I/O	200Ω, level adjustable
Front Panel Controls	Power button, REGISTER Beltpac and CLR/BND buttons, RESET switch, HEADSET IN and OUT level adjustments, 4-Wire IN and OUT level adjustments
Front Panel Indicators	POWER LED, STATUS display, IC and ISO Receive LEDs, Battery Charger RDY and CHG LEDs
Rear Panel Controls	Primary/Secondary switch
Antenna Type	External ½ -wave dipole (R-TNC connector) RX/TX horizontal/vertical diversity
System Distortion	<2%
Communication Security	64-bit encryption dual-slot diversity

#### TRANSMITTER

Type	Frequency hopping, spread spectrum
Transmit Power	100mW burst
Modulation Type	Gaussian filtered FSK, TDMA
Frequency Stability	13 ppm
Harmonics/Spurious	Exceeds FCC and ETSI specifications over temperature

#### RECEIVER

Type	Frequency hopping, spread spectrum
RF Sensitivity	<-0dBm w 10-3 BER
Frequency Stability	13 ppm
Distortion	<2%

#### BATTERY CHARGER

Battery charging time	<3 hours
-----------------------	----------

## **BP200 BELTPAC**

Frequency Range	2400 MHz – 2483.5 MHz
Antenna	Internal, horizontal/vertical diversity
Frequency Response	200 Hz to 3.5 kHz
Transmit Power	100mW burst
RF Sensitivity	<-0dBm w 10-3 BER
Battery Requirements	3.6V lithium ion, rechargeable
Battery Life	Hands-free – up to 14 hours, PTT – up to 20 hours
Temperature Range	32-122°F (0-50°C)
Weight	7.4 oz (.21 kg) with battery and pouch
Headset Connector	4-pin, mini-DIN
Microphone	Electret
Headset Output	160mW into 32Ω
Controls	Power, Volume-up ▲, Volume-down ▼, IC, ISO
Indicators	Dual-color LED (red/green)

## **WH220 ALL-IN-ONE HEADSET**

Frequency Range	2400 MHz – 2483.5 MHz
Antenna	Internal
Frequency Response	200 Hz to 3.5 kHz
Transmit Power	100mW burst
RF Sensitivity	<-0dBm w 10-3 BER
Battery Requirements	3.6V lithium ion, rechargeable
Battery Life	Hands-free – up to 14 hours, PTT – up to 20 hours
Temperature Range	32-122°F (0-50°C)
Weight	5.7 oz (.16 kg) with battery
Microphone	Electret
Headset Output	160mW into 32Ω
Controls	Power, Volume-up ▲, Volume-down ▼, IC1, IC2, ISO
Indicators	Transmit LED (red/green), Power LED (red/green)

**NOTE:** Beltpac or headsets will follow the frequency range determined by the setting on the Base Station (e.g. All, Low or High).

# SECTION 7. INDEX

## Base Station

Antenna mounting .....	7
Battery charging .....	8
Block diagram .....	28
Features .....	5
Initialization (multiple base stations) .....	10
Intercom and relay connections .....	16
Interference avoidance .....	9
Operation .....	17
Power connection .....	8
Setup (multiple base stations) .....	9
Setup (single base station) .....	7
Setup (split-band) .....	9
Specifications .....	25

## Beltpac

Battery changing .....	19
Features .....	6
Microphone gain adjustment .....	19
Operation .....	18
Registration .....	12
Setup .....	12
Sidetone adjustment .....	19
Specifications .....	25

## Headset, All-In-One

Battery changing .....	21
Features .....	6
Microphone gain adjustment .....	21
Operation .....	20
Registration .....	14
Setup .....	14
Specifications .....	25

## Operation

All-in-one headset .....	20
Base station .....	17
Beltpac .....	18
Quick Reference Guide .....	1

## System

Applications .....	2
Equipment identification .....	4
Equipment specifications .....	25
Introduction .....	2
Optional equipment .....	4
Troubleshooting .....	22



# BASE STATION BLOCK DIAGRAM

