

ATEM 4 M/E Broadcast Studio 4K



Get one of the world's most compact and advanced switchers with the new ATEM 4 M/E Broadcast Studio 4K. You get an incredibly high performance live production switcher designed to work with the latest formats and high frame rates, all the way up to Ultra HD 2160p59.94! You get 16 next generation ATEM Advanced Chroma Keyers with 4 per M/E, perfect for advanced work and virtual sets. As the most advanced ATEM switcher, this model also includes the latest technology and features such as 2 Ultra HD multi viewers, full 2D DVE, built in SuperSource compositing engine with 4 picture in picture DVE's, full re-synchronization on each 12G-SDI input and much more! The multi rate 12G-SDI connections automatically switch between all HD and Ultra HD formats up to 2160p59.94 with a single BNC cable! Even if you're not working in Ultra HD now, the ATEM 4 M/E Broadcast Studio 4K has all the power and features for the highest end live production work, while being Ultra HD ready the instant you need it!

\$5,995

Connections

Total Video Inputs

20

Total Video Outputs

13

Total Aux Outputs

6

SDI Rates

1.5G, 3G, 6G, 12G

Total Audio Inputs

2 x XLR. 2 x RCA.

Total Audio Outputs

2 x XLR Program 2 x XLR Monitor.

Timecode Connections

1 x XLR Timecode in and 1 x XLR Timecode out.

Reference Input

Tri-Sync or Black Burst.

Video Input Re-Sync

On all 20 inputs.

SDI Video Inputs

20 x 10-bit HD/Ultra HD 4K switchable. 2 channel embedded audio.

Extra Audio Outputs

1 x XLR Timecode and 1 x XLR Talkback.

SDI Audio Outputs

2 Ch embedded into SDI output on all outputs.

Extra Audio Inputs

1 x XLR Timecode and 1 x XLR Talkback.

SDI Program Outputs

3 x 10-bit HD/Ultra HD 4K switchable.

Down Converted SDI Program Output

1 x 10-bit (From Ultra HD 4K to HD).

SDI Preview Outputs

1 x 10-bit HD/Ultra HD 4K switchable.

Total Multi Views

2

SDI Multi View Outputs

2

Control Panel Connection

Ethernet supports 10/100/1000 BaseT. Allows direct connection between panel and chassis, or via network.

Tally Output

Added via ethernet connection to Blackmagic Design GPI and Tally Interface product. (Not included).

Computer Interface

1 x USB 2.0 port.

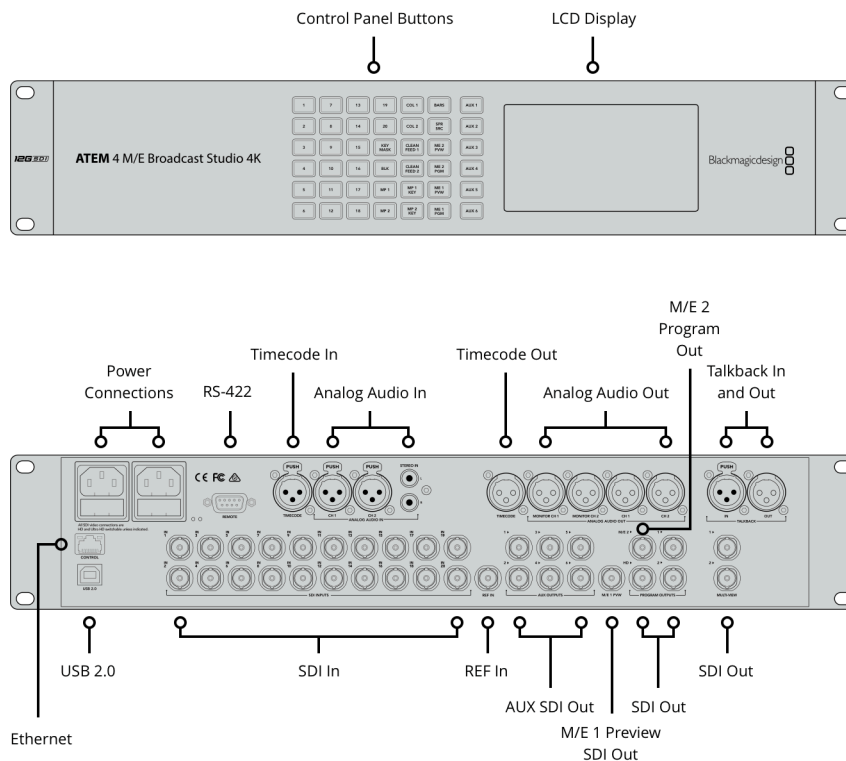

Standards

SD Video Standards

None

HD Video Standards

720p50, 720p59.94,
1080p23.98, 1080p24, 1080p25,
1080p29.97, 1080p50, 1080p59.94
1080i50, 1080i59.94

Ultra HD Video Standards

2160p23.98, 2160p24, 2160p25,
2160p29.97, 2160p50, 2160p59.94

SDI Compliance

SMPTE 292M, SMPTE 424M, SMPTE
2082.

Video Sampling

4:2:2

Color Precision

10-bit.

Color Space

REC 601, REC 709, REC 2020.

Product Specifics

Upstream Keyers

16 with Chroma/Linear/Luma key.

Downstream Keyers

2

Chroma Keyers

16

Talkback Support

None

Mix Minus Support

None

Linear/Luma Keyers

19

Transition Keyer (Stinger/DVE)

1 Stinger, 1DVE .

Total Number of Layers

26

Pattern Generators

19

Color Generators 2	Control Panel Software or optional hardware panel.	Tally Red for program and green for preview indication.
DVE with 3D Borders & Drop Shadow 1	Routable Windows 16	Windows Source Labels Yes

Multi View Monitoring

Multi View Monitoring 2 x 10 Views for 20 total views.	Multi View Video Standard Select HD or Ultra HD.
--	--

Media Player

Media Players 4	Media Player Clip Length in 720 HD 3200 frames.	Media Pool Still Image Format PNG, TGA, BMP, GIF, JPEG and TIFF.
Media Pool Still Image Capacity 64 with fill and key.	Media Player Clip Length in 1080 HD 1440 frames.	Media Pool Video File Format TGA Sequence.
Media Pool Clip Capacity 2 with fill and key.	Media Player Clip Length in Ultra HD 360 frames.	Media Pool Audio File Format WAV, MP3 and AIFF.

Display

Interface Minimum monitor resolution of 1366 x 768.	Front panel Built in HD LCD monitor for video and 42 LED buttons for Aux switching.
---	---

Processing

Processing Delay < 7 Lines	Selectable On/Off/Audio-Follow-Video.	Dedicated analog outputs for monitoring.
Audio Mixer 24 input x 2 channel mixer.	Level and Peak metering. Master gain control.	4K to HD Down Conversion Yes, program x 1.

Software

Control Panel Included ATEM Software Control Panel included free for Mac 10.12 Sierra, Mac 10.13 High Sierra or later and Windows 8.1 64-bit or Windows 10 64-bit.	Software Updates Using USB 2.0 connection directly connected to Mac OS or Windows computers. Includes ATEM Setup Utility.	Configuration Set via ATEM Software Control Panel, excluding ATEM chassis IP address which is set via the ATEM Setup Utility connected via USB to chassis.
--	---	--

Operating Systems



Mac 10.14 Mojave,
Mac 10.15 Catalina or later.



Windows 8.1 and 10.

Power Requirements

Power Supply

2 x Internal 100 - 240 AC.

Power Usage

300W

Physical Specifications

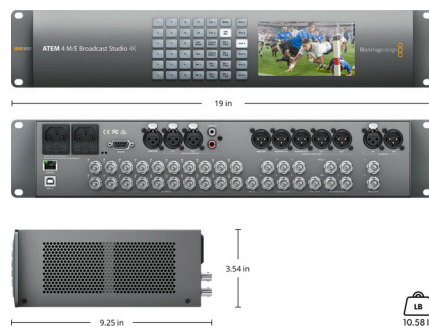

Physical Installation

Physical Installation

2 Rack Unit Size.

Environmental Specifications

Operating Temperature

0° to 40° C (32° to 104° F)

Storage Temperature

-20° to 60° C (-4° to 140° F)

Relative Humidity

0% to 90% non-condensing

What's Included

ATEM 4 M/E Broadcast Studio 4K

Welcome wallet with QR code for software download

Warranty

12 Month Limited Manufacturer's Warranty.

All items on this website are copyright Blackmagic Design Pty. Ltd. 2022, all rights reserved. All trademarks are property of their respective owners. MSRP includes duties, but excludes sales tax and shipping costs. This website uses remarketing services to advertise on third party websites to previous visitors to our site. You can opt out at any time by changing cookie settings. [Privacy Policy](#)

Blackmagic Design Authorized Reseller