

ATEM 2 M/E Production Studio 4K



The new ATEM 2 M/E Production Studio 4K lets you produce broadcast quality live multi camera production in SD, HD or amazing Ultra HD! Featuring 20 inputs with built in re-synchronizers so you can connect the widest range of video sources such as cameras, disk recorders and computers for incredible live music, sport and more! ATEM 2 M/E Production Studio 4K has advanced broadcast features such as chroma key, customizable transitions, upstream and downstream keyers, DVE, Super Source, audio mixer, 2 x multi views, media pool and more! You also get 6G-SDI and HDMI 4K connections and 6 auxiliary outputs for the most advanced live production switching!

\$3,995

Connections

Total Video Inputs

21 with 20 active

Total Video Outputs

16

Total Aux Outputs

6

SDI Rates

270Mb, 1.5G, 3G, 6G.

Total Audio Inputs

2 x XLR. 2 x RCA.

Total Audio Outputs

2 x XLR Program 2 x XLR Monitor.

Timecode Connections

1 x XLR in and 1 x XLR out.

Reference Input

Tri-Sync or Black Burst.

Video Input Re-Sync

On all 20 inputs.

SDI Video Inputs

20 x 10-bit SD/HD/Ultra HD 4K switchable. 2 channel embedded audio.

HDMI Video Input

1 x HDMI type A. 10-bit SD/HD/Ultra HD 4K switchable. 2 channel embedded audio.

SDI Audio Outputs

2 Ch embedded into SDI output on all outputs.

SDI Program Outputs

3 x 10-bit SD/HD/Ultra HD 4K switchable.

HDMI Program Outputs

1 x HDMI type A, 10-bit SD/HD/Ultra HD 4K switchable.

Down Converted SDI

Program Outputs

1 x 10-bit (Ultra HD 4K to HD).

SDI Preview Outputs

1 x 10-bit SD/HD/Ultra HD 4K switchable.

Total Multi Views

2

SDI Multi View Outputs

2

HDMI Multi View Outputs

2

Control Panel Connection

Ethernet supports 10/100/1000 BaseT. Allows direct connection between panel and chassis, or via network.

Tally Output

Added via ethernet connection to Blackmagic Design GPI and Tally Interface product. (Not included.)

Computer Interface

1 x USB 2.0 port.

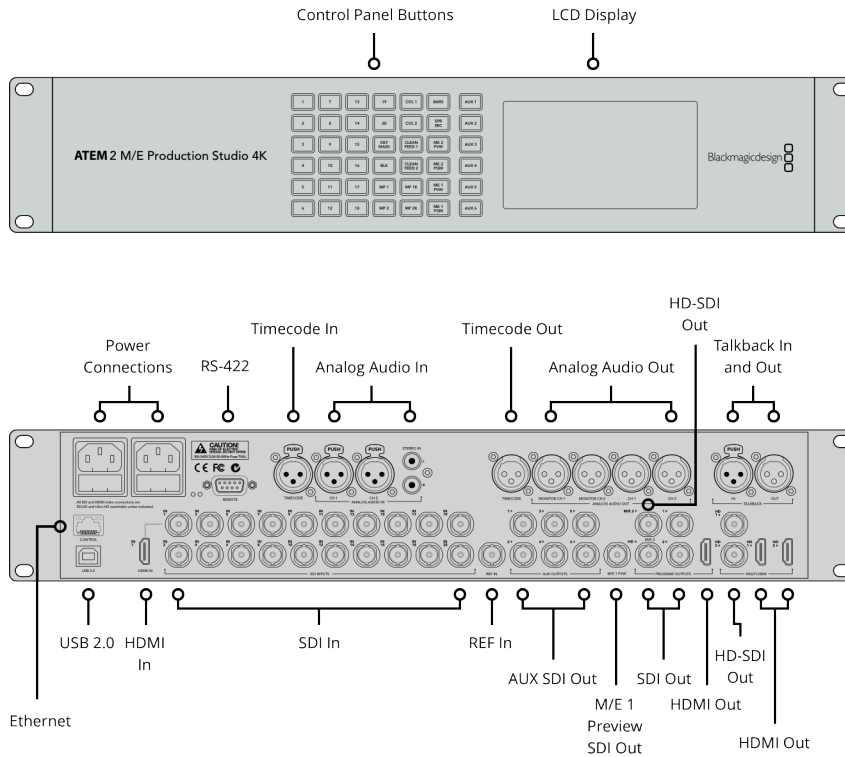

Standards

SD Video Standards

525i59.94 NTSC, 625i50 PAL

HD Video Standards

720p50, 720p59.94
 1080p23.98, 1080p24, 1080p25,
 1080p29.97, 1080p50, 1080p59.94
 1080i50, 1080i59.94

Ultra HD Video Standards

2160p23.98, 2160p24, 2160p25,
 2160p29.97

SDI Compliance

SMPTE 259M, SMPTE 292M, SMPTE
 424M.

Video Sampling

4:2:2

Color Precision

10-bit

Color Space

REC 601, REC 709, REC 2020.

HDMI Input Resolutions for Computers

720 x 480i 59.94Hz,
 720 x 576i 50Hz,
 1280 x 720 59.94Hz,
 1280 x 720 50Hz,
 1920 x 1080 50Hz,
 1920 x 1080 59.94Hz,
 3840 x 2160 23.98Hz,
 3840 x 2160 24Hz,
 3840 x 2160 25Hz,
 3840 x 2160 29.97Hz.
 Note: Also supported are; 24, 30 and
 60 Hz inputs when switcher is in
 23.98, 29.97 and 59.94 Hz
 formats respectively.

Product Specifics

Upstream Keys

4 with Chroma/Linear/Luma key.

Chroma Keys

4

Mix Minus Support

None

Downstream Keys

2

Talkback Support

None

Linear/Luma Keys

7

Transition Keyer (Stinger/DVE) 1 Stinger, 1 DVE.	Pattern Generators 8	Drop Shadow 1
Total Number of Layers 13	Color Generators 2	Control Panel Software or optional hardware panel
	DVE with 3D Borders &	

Media Player

Media Players 2	Media Player Clip Length in NTSC/PAL 3600 frames.	4K 180 frames
Channels Fill and key for each media-player.	Media Player Clip Length in 720p 1600 frames	Media Pool Still Image Format PNG, TGA, BMP, GIF, JPEG and TIFF.
Media Pool Still Image Capacity 32 with fill and key	Media Player Clip Length in 1080 720 frames	Media Pool Video File Format TGA Sequence.
Media Pool Clip Capacity 2 with fill and key.	Media Player Clip Length in Ultra HD	Media Pool Audio File Format WAV, MP3 and AIFF.

Multi View Monitoring

Multi View Monitoring 2 x 10 Views for 20 total views.	Routable Windows 16	Windows Source Labels Yes
Multi View Video Standard HD.	Tally Red for program and green for preview indication.	

Display

Interface Minimum monitor resolution of 1366 x 768.	Front Panel Built in LCD monitor for video and 42 LED buttons for Aux switching.
---	--

Processing

Colorspace Conversion Hardware based real time.	Audio Mixer 22 input x 2 channel mixer. Selectable On/Off/Audio-Follow-Video. Level and Peak metering. Master gain control. Dedicated analog outputs for monitoring.
Processing Delay < 2 Lines	
4K to HD Down Conversion Yes, program x 1	

Software

Control Panel Included

ATEM Software Control Panel included free for Mac 10.12 Sierra, Mac 10.13 High Sierra or later and Windows 8.1 64-bit or Windows 10 64-bit.

Software Updates

Using USB 2.0 connection directly connected to Mac OS or Windows computers. Includes ATEM Setup Utility.

Configuration

Set via ATEM Software Control Panel, excluding ATEM chassis IP address which is set via the ATEM Setup Utility connected via USB to chassis.

Operating Systems

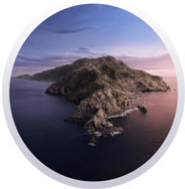

Mac 10.14 Mojave,
Mac 10.15 Catalina or later.



Windows 8.1 and 10.

Power Requirements

Power Supply

2 x Internal 100 - 240V AC.

Power Usage

150 W

Physical Specifications

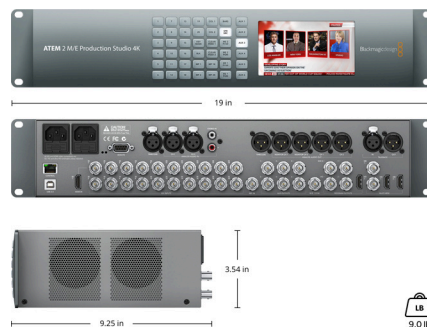

Physical Installation

Physical Installation

2 Rack Unit Size.

Environmental Specifications

Operating Temperature

0° to 40° C (32° to 104° F)

Storage Temperature

-20° to 60° C (-4° to 140° F)

Relative Humidity

0% to 90% non-condensing

What's Included

AEM 2 M/E Production Studio 4K

Welcome wallet with QR code for software download

Warranty

12 Month Limited Manufacturer's Warranty.

All items on this website are copyright Blackmagic Design Pty. Ltd. 2022, all rights reserved. All trademarks are property of their respective owners. MSRP includes duties, but excludes sales tax and shipping costs. This website uses remarketing services to advertise on third party websites to previous visitors to our site. You can opt out at any time by changing cookie settings. [Privacy Policy](#)

Blackmagic Design Authorized Reseller