TELEX

ICW-6 Window Intercom

Installation and Operation Instructions



Proprietary Notice

The product information and design disclosed herein were originated by and are the property of Bosch Security Systems, Inc. Bosch reserves all patent, proprietary design, manufacturing, reproduction, use and sales rights thereto, and to any article disclosed therein, except to the extent rights are expressly granted to others.

Copyright Notice

Copyright 2009 by Bosch Security Systems, Inc. All rights reserved. Reproduction, in whole or in part, without prior written permission from Bosch is prohibited.

Warranty Notice

See the enclosed warranty card for further details.

Customer Support

Technical questions should be directed to:

Customer Service Department
Bosch Security Systems, Inc.
12000 Portland Avenue South
Burnsville, MN 55337 USA
Telephone: 800-392-3497
Fax: 800-323-0498
Factory Service: 800-553-5992

Return Shipping Instructions

Parts & Service Department
Bosch Security Systems, Inc. (Lincoln, NE)
Telephone: 402-467-5321
Fax: 402-467-3279
Factory Service: 800-553-5992

Please include a note in the box which supplies the company name, address, phone number, a person to contact regarding the repair, the type and quantity of equipment, a description of the problem and the serial number(s).

Shipping to the Manufacturer

All shipments of product should be made via UPS Ground, prepaid (you may request from Factory Service a different shipment method). Any shipment upgrades will be paid by the customer. The equipment should be shipped in the original packing carton. If the original carton is not available, use any suitable container that is rigid and of adequate size. If a substitute container is used, the equipment should be wrapped in paper and surrounded with at least four (4) inches of excelsior or similar shock-absorbing material. All shipments must be sent to the following address and must include the Proof of Purchase for warranty repair. Upon completion of any repair the equipment will be returned via United Parcel Service or specified shipper, collect.

Factory Service Department
Bosch Security Systems, Inc.
8601 East Cornhusker Hwy.
Lincoln, NE 68507 U.S.A.
Attn: Service



Table of Contents

| | |
|---|----|
| Introduction | 3 |
| Unpacking and Inspection | 3 |
| Recommended Items | 4 |
| Specifications | 4 |
| Accessories | 5 |
| | |
| Installation and Operation | 7 |
| Installation | 7 |
| Operation | 11 |
| Inside and Outside Mic Adjustment Pot | 11 |
| Mic Adjustment Pot Location | 11 |

Introduction

IMPORTANT: Use the power supply included with the ICW-6. Use of any other power supply could damage the ICW-6 and will void the warranty

Unpacking and Inspection**ICW-6 Package**

- A.** Cordset - European
- B.** Cordset - U.S.A.
- C.** ICW-6 Final Assembly
 1. Operator-Side Assembly
 2. Customer-Side Assembly
- D.** Switching Power Supply
- E.** Installation Kit
 - #6 screws 1" (3)
 - #6 washers (3)
 - Cable Tie
- F.** User Manual (not shown)
- G.** Mounting Template (not shown)
- H.** Quick Start Guide (not shown)
- I.** Warranty Card (not shown)

FIGURE 1. ICW-6 System Components

Unpack the equipment from the shipping case and inspect for missing or damaged components. You should have all of the items listed in Figure 1 .

Recommended Items

- No.1 Phillips screwdriver
- Equipment for cutting/drilling hole(s) for mounting (See Installation section for details)
- 1" wide transparent tape
- Scissors (For cutting the mounting template from the last page).

Specifications

General

Power Requirement

50mA max @ 110-240VAC, 5VDC 600mA maximum

System Frequency Response

200 to 4.5 kHz \pm 3 dB

Environmental

-20° C to 55° C, 0% to 90% humidity, non-condensing

Outputs

External Speaker

2W: 100dB SPL at 1ft. at 1 kHz, C weighting

Internal Speaker

2W: 100dB SPL at 1ft. at 1 kHz, C weighting

Note: *These are sine wave maximums. Voice measurements will range 70 to 90 dB SPL.*

Headphones

80 mW: 100dB peak SPL

Voice Range: 84 to 104 dB SPL

Impedance: 50 Ω

Inputs

Internal Panel Microphone

Electret: 4 mv at 1kHz, typical into 1000 ohms source impedance

External Headset Microphone

Dynamic: range 4 mv at 1kHz, typical into 200 ohms

Source Impedance Dynamic: 200 ohms

Options

Gooseneck Microphone

MCP-90-3, MCP-90-8, MCP-90-12, MCP-90-18

Headsets

PH-44-IC3 (Dual Headphone), PH-88-IC3 (Single Headphone)

Accessories

| Description | Part Number |
|--------------------|--------------------|
| MCP-90-12 | 301029000 |
| MCP-90-18 | 301030000 |
| PH-88-IC3 | 300852300 |
| PH-44-IC3 | 300853300 |
| PH-88-IC3-QD | 300853301 |
| PH-44-IC3-QD | 300853300 |

*Installation and
Operation*

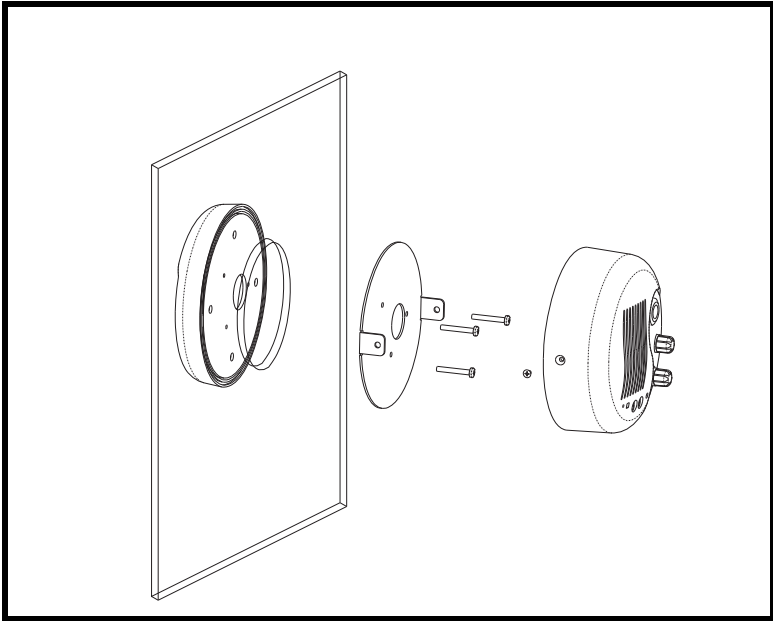

FIGURE 2. ICW-6 Assembly Detail

Installation

1. Remove the **two (2) screws** holding the mounting plate to the operator assembly. (See Figure 2 .)
2. Measure and identify the **location** where the intercom is to be mounted.

3. Attach the **mounting template** (supplied in box) to the window (customer assembly side) being sure to center the appropriate guide in the location identified in step 2.

NOTE: Use either the single large hole, or multiple small holes depending on which method you choose. Using the multiple small hole method with bullet-proof glass will afford maximum operator protection (Figure 4).

4. Cut and/or drill the **hole(s)** from the customer assembly side.
5. Have an assistant place the **customer assembly** against the window. Make sure the holes line up correctly.
6. Attach the **mounting plate** removed from the operator assembly (See Step 1) using the three (3) supplied mounting screws and rubber washers. (See Figure 5).
7. Remove the lower left screw and washer and attach the ground wire (See Figure 6).
8. Attach the **cable harness** from the customer assembly to the connector on the operator assembly (See Figure 6).
9. Attach the **operator assembly to the mounting plate** using the screws removed in Step 1.
10. Screw the **threaded end** of the ICW-6 power supply interface cord into the ICW-6. *The connector is located on the bottom of the ICW-6 on the operator assembly side.*
11. Secure the **cord** to the glass using wide clear adhesive tape.
12. Connect the **power supply to AC power** using the supplied IEC cord.
13. Attach the **ICW-6's power cord** to the power supply.

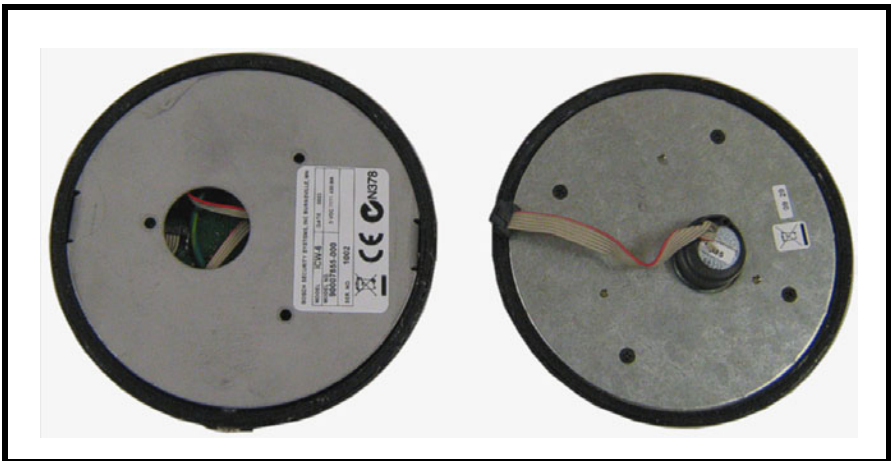

FIGURE 3. Operator and Customer assemblies

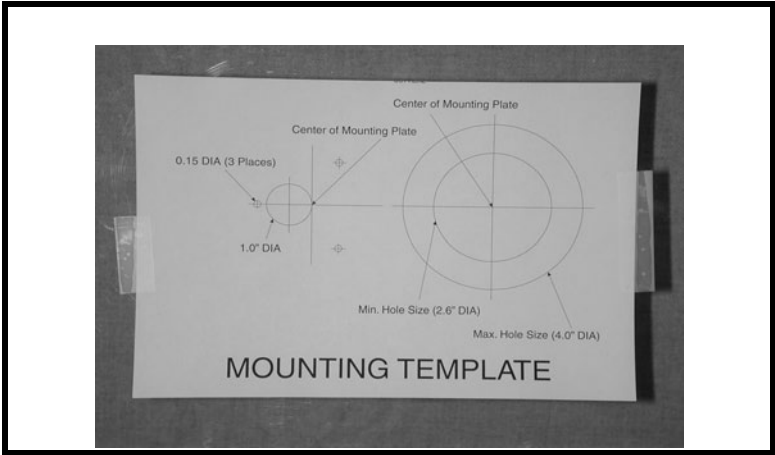

FIGURE 4. Mounting Template

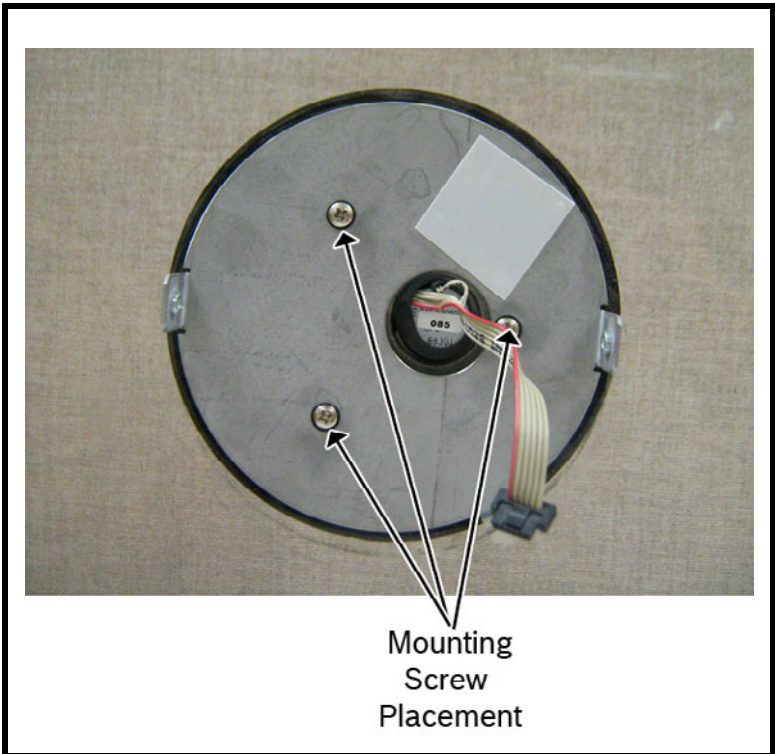

FIGURE 5. Customer Side Mounted

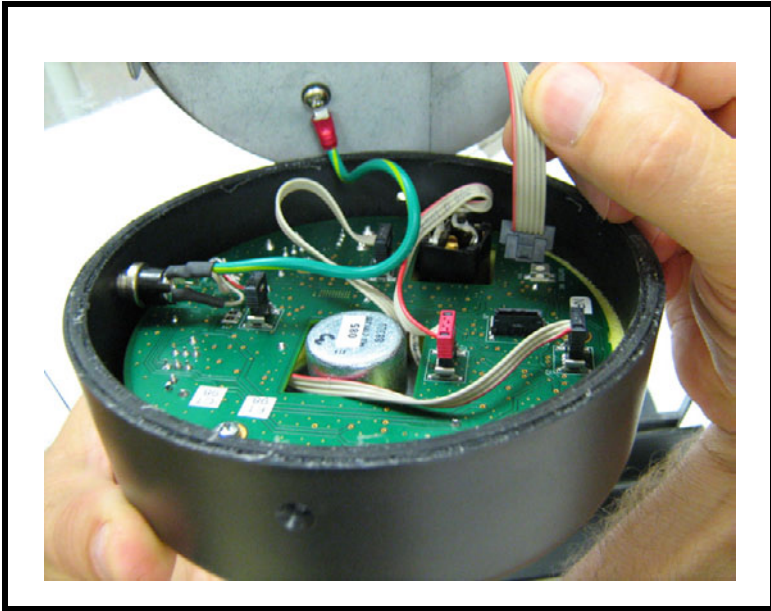
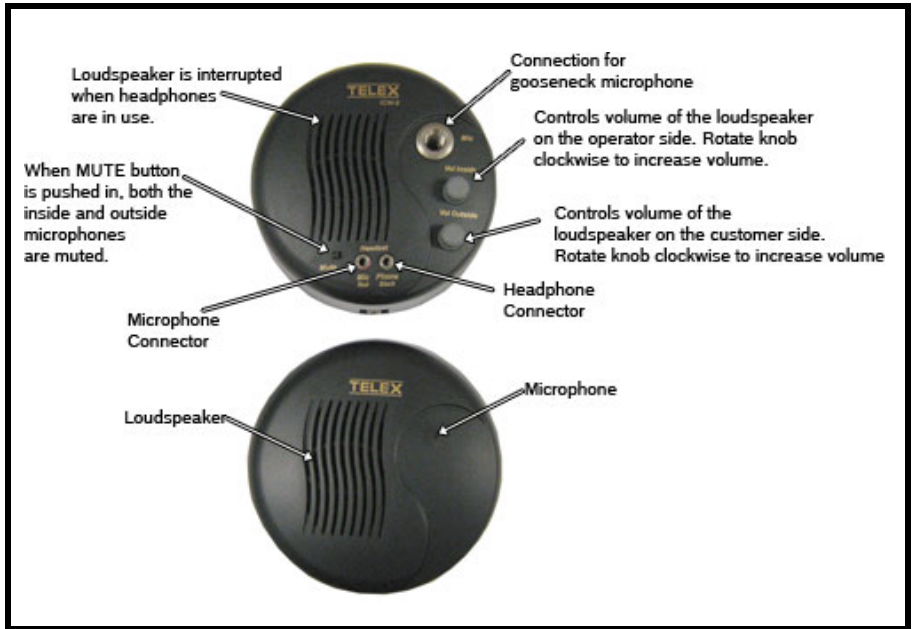

FIGURE 6. Connecting customer and operator assemblies prior to final mounting.

Operation



Inside and Outside Mic Adjustment Pot

On the ICW-6, you can adjust the sensitivity of the inside and outside mic. This means the how far away from the microphone a person can stand to talk and still be heard.

Mic Adjustment Pot Location

By default, the following applies:

The inside mic is set midpoint, 2" - 3" Speak Zone

The outside mic is set midpoint, 1' - 2' Speak Zone

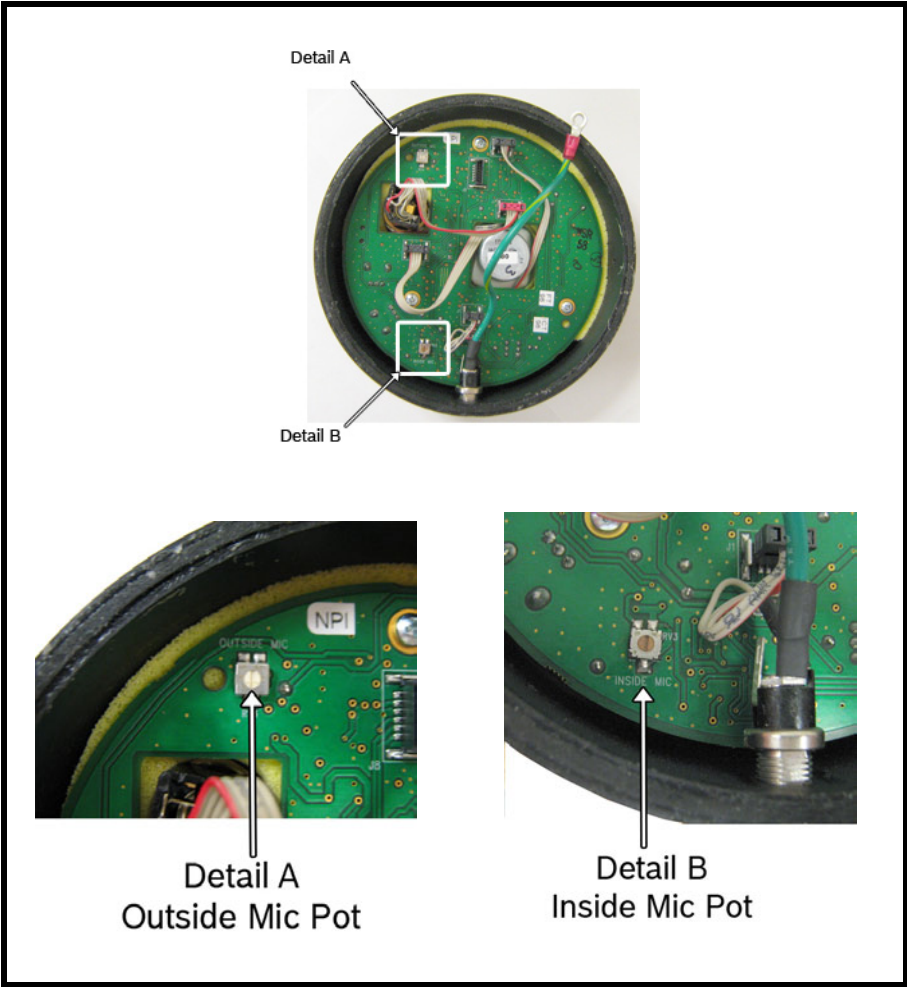

FIGURE 7. ICW-6 Inside and Outside Mic Pot Location

To **adjust the inside or outside mic sensitivity level**, do the following:

1. Using a small screwdriver, remove the **two (2) side screws** from the operator side unit.



FIGURE 8. Side Screws Holding the Back Plate to the Operator Unit

2. Carefully remove the **back plate** from the operator side unit.
3. Using Figure 7 , locate the **mic pot** you want to adjust.
4. With a flathead screwdriver, turn the **mic pot clockwise** to increase the sensitivity.
OR
Turn the **mic pot counter-clockwise** to decrease the sensitivity.

