

Canon

SPEEDLITE EL-5



Advanced User Guide

E

Contents

Introduction.	4
Supplemental Information.	5
Compatible Accessories.	6
Instruction Manual.	7
About This Guide.	8
Safety Instructions.	10
Part Names.	12
Getting Started and Basic Operations.	25
Charging the Battery.	26
Inserting the Battery.	30
Attaching and Detaching the Speedlite.	32
Turning on the Power.	34
Fully Automatic Flash Photography.	39
E-TTL II / E-TTL Autoflash, by Shooting Mode.	41
Checking Battery Information.	46
Advanced Flash Photography.	48
Flash Exposure Compensation.	49
Flash Exposure Bracketing.	51
FE Lock.	53
High-Speed Sync.	54
Second-Curtain Sync.	56
Bounce.	58
Flash Coverage Setting.	62
Manual Flash.	66
Stroboscopic Flash.	73
Modeling Lamp.	77
Modeling Flash.	78
Clearing Speedlite Settings.	79
Setting Flash Functions from the Camera.	81
Flash Control from the Camera Menu.	82

Radio Transmission Wireless Flash Photography.	89
Radio Transmission Wireless Flash Photography.	90
Wireless Settings.	96
Autoflash with One Receiver.	109
Autoflash with Two Receiver Groups.	117
Autoflash with Three Receiver Groups.	121
Wireless Multiple-Flash Photography with Flash Ratio.	126
Shooting in Group-Specific Flash Modes.	130
Firing Test Flash/Modeling Flash from Receivers.	135
Remote Release from Receivers.	137
Linked Shooting.	139
Customizing the Speedlite.	145
Setting Custom and Personal Functions.	146
Customization with Custom Functions.	153
Customization with Personal Functions.	157
Custom Flash Modes.	162
Reference.	172
Flash Firing Restriction Due to Temperature Increase.	173
Troubleshooting Guide.	177
Specifications.	183
Accessories.	192

Introduction

Designed for EOS cameras equipped with a multi-function shoe, the Canon EL-5 is an external Speedlite compatible with E-TTL II / E-TTL autoflash. In normal flash photography, it can be used as an on-camera flash attached to a multi-function shoe, and radio transmission wireless flash photography, it can be used as a sender or receiver. Dust and water resistance is equivalent to the EOS R5.

Read before use

To avoid shooting problems and accidents, first read the [Safety Instructions](#). Also read this Advanced User Guide carefully to ensure correct use.

Read in conjunction with the camera instruction manual

Before use, read this guide and the Advanced User Guide of your camera to familiarize yourself with operations and ensure correct use.

*** Explanations in this guide are based on use with an EOS Digital camera.**

Precaution on continuous flash firing

Flash units fire repeatedly in continuous shooting with flash or when you shoot with features such as stroboscopic or modeling flash. Some people may experience seizures or similar symptoms from visual overstimulation caused by continuous flash firing (including light reflected off brightly colored walls or other surfaces). If you or others experience these symptoms, stop firing the flash units immediately.

- [Supplemental Information](#)
- [Compatible Accessories](#)
- [Instruction Manual](#)
- [About This Guide](#)
- [Safety Instructions](#)
- [Part Names](#)

Supplemental Information

Check the following website for supplemental information about the Speedlite.

- <https://cam.start.canon/H001/>



Compatible Accessories

Check the following website for the latest compatible cameras and accessories.

- <https://cam.start.canon/H002/>



Instruction Manual



The included Instruction Manual provides basic instructions on flash photography.

- **Advanced User Guide**

Complete instructions are provided in this Advanced User Guide.
For the latest Advanced User Guide, refer to the following website.
<https://cam.start.canon/A006/>





About This Guide





 [Icons in This Guide](#)

 [Basic Assumptions](#)

Icons in This Guide

	Indicates the select dial.
	Indicates the duration (approx. 12 or 16 sec.) of the operation for the button you pressed, based on when you release the button.

- In reference to buttons or setting positions, the guide uses the same icons or display items found on the Speedlite.

	Links to pages with related topics.
	Warning to prevent shooting problems.
	Supplemental information.
	☆ to the right of page titles indicates functions only available with the camera set to Creative Zone modes (<Fv>, <P>, <Tv>, <Av>, , or <M>).
	Troubleshooting tips.

Basic Assumptions

- Instructions apply to the Speedlite and camera with the power on (🔌).
- The icons used for buttons, dials, and symbols in the text match the icons found on the Speedlite and the camera.
- Functions can be set by pressing the joystick vertically or horizontally or turning < ⌚ > for selection.
- Function setup is exited by pressing the < ↶ > button.
- Default settings are assumed for Custom/Personal Functions of the Speedlite, as well as menu functions/Custom Functions of the camera.

Safety Instructions

Be sure to read these instructions in order to operate the product safely.
Follow these instructions to prevent injury or harm to the operator of the product or others.

 **WARNING:** Denotes the risk of serious injury or death.

- Keep batteries out of the reach of children.
- Use only power sources specified in this instruction manual for use with the product.
- Do not disassemble or modify the product.
- Do not expose the product to strong shocks or vibration.
- Do not touch any exposed internal parts.
- Stop using the product in any case of unusual circumstances such as the presence of smoke or a strange smell.
- Do not use organic solvents such as alcohol, benzene or paint thinner to clean the product.
- Do not get the product wet. Do not insert foreign objects or liquids into the product.
- Do not use the product where flammable gases may be present.

This may cause electric shock, explosion or fire.

- Do not touch the product connected to a power outlet during lightning storms.

This may cause electric shock.

- Observe the following instructions when using commercially available batteries or provided battery packs.
 - Use batteries/battery packs only with their specified product.
 - Do not heat batteries/battery packs or expose them to fire.
 - Do not charge batteries/battery packs using non-authorized battery chargers.
 - Do not expose the terminals to dirt or let them come into contact with metallic pins or other metal objects.
 - Do not use leaking batteries/battery packs.
 - When disposing of batteries/battery packs, insulate the terminals with tape or other means.

This may cause electric shock, explosion or fire.

If a battery/battery pack leaks and the material contacts your skin or clothing, flush the exposed area thoroughly with running water. In case of eye contact, flush thoroughly with copious amounts of clean running water and seek immediate medical assistance.

- Observe the following instructions when using a battery charger.
 - Periodically remove any dust buildup from the power plug and power outlet using a dry cloth.
 - Do not plug in or unplug the product with wet hands.
 - Do not use the product if the power plug is not fully inserted into the power outlet.
 - Do not expose the power plug and terminals to dirt or let them come into contact with metallic pins or other metal objects.
 - Do not touch the battery charger or AC adapter connected to a power outlet during lightning storms.
 - Do not place heavy objects on the power cord. Do not damage, break or modify the power cord.
 - Do not wrap the product in cloth or other materials when in use or shortly after use when the product is still warm in temperature.
 - Do not leave the product connected to a power source for long periods of time.
 - Do not charge batteries/battery packs at temperatures outside the range of 5 - 40 °C (41 - 104 °F).

This may cause electric shock, explosion or fire.

- Do not allow the product to maintain contact with the same area of skin for extended periods of time during use.

This may result in low-temperature contact burns, including skin redness and blistering, even if the product does not feel hot.

- Follow any indications to turn off the product in places where its use is forbidden.

Not doing so may cause other equipment to malfunction due to the effect of electromagnetic waves and even result in accidents.

- Do not leave batteries near pets.

Pets biting a battery could cause leakage, overheating, or explosion, resulting in product damage or fire.



CAUTION

Follow the cautions below. Otherwise physical injury or property damage may result.

- Do not fire the flash near the eyes.

It may hurt the eyes.

- Flash emits high temperatures when fired. Keep fingers, any other part of your body, and objects away from the flash unit while taking pictures.

This may cause burns or malfunction of the flash.

- Do not leave the product in places exposed to extremely high or low temperatures.

The product may become extremely hot/cold and cause burns or injury when touched.

- Do not touch any parts inside the product.

This may cause injury.

Part Names

- [LCD Panel](#)
- [Battery Charger LC-E6 \(Sold Separately\)](#)
- [Battery Charger LC-E6E \(Sold Separately\)](#)
- [Included Accessories](#)

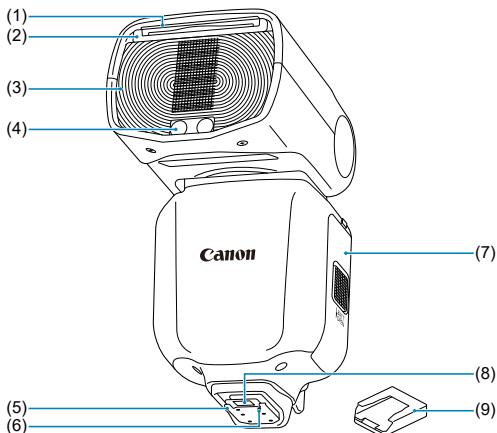

-
- | | |
|-----|--|
| (1) | Catchlight panel (shown stowed) |
| (2) | Wide panel (shown stowed) |
| (3) | Flash head (light-emitting unit) |
| (4) | Modeling lamp / AF-assist beam emitter |
| (5) | Mounting foot |
| (6) | Mounting foot locking pin |
| (7) | Battery compartment cover |
| (8) | Contacts |
| (9) | Mounting foot cover |
-

 **Note**



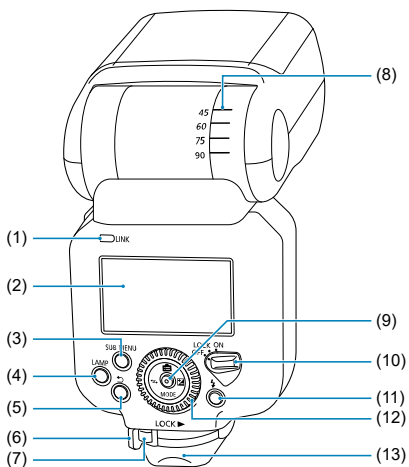





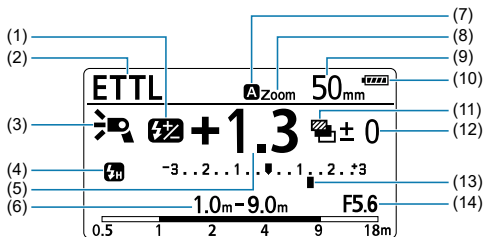





- Not equipped with remote release terminal (release cable SR-N3 cannot be used).



-
- (1) <LINK> Radio transmission confirmation lamp
-
- (2) LCD panel
-
- (3) <SUB MENU> Sub menu button
-
- (4) <LAMP> LAMP button
-
- (5) <↶> Undo button
-
- (6) Mounting foot lock lever
-
- (7) Lock-release button
-
- (8) Bounce angle index
-
- (9) Joystick
<☰> Menu direct
<MODE> Flash mode
<↔> Wireless / linked shooting setting
<☒> Flash exposure compensation / flash output setting
-
- (10) Power switch
<ON> Power ON
<LOCK> Button / dial lock (Power ON)
<OFF> Power OFF
-
- (11) <⚡> Flash-ready lamp / test flash button
-
- (12) <⦿> Select dial
-
- (13) Dust-proof and drip-proof adapter
-

E-TTL II / E-TTL autoflash (🔗)



-
- (1) <  > Flash exposure compensation
-
- (2) < **E-TTL** > E-TTL II / E-TTL autoflash
 < **C1** > / < **C2** > / < **C3** > Custom flash mode*¹
-
- (3) <  > Standard
 <  > Guide number priority
 <  > Even coverage
 <  > Bounce upward
 <  > Bounce downward
 <  > Temperature increase (flash firing restriction)
 <  > Modeling lamp lit
-
- (4) <  > First-curtain sync (normal shooting)
 <  > Second-curtain sync
 <  > High-speed sync
-
- (5) Flash exposure compensation amount
-
- (6) Effective flash range / shooting distance
 < **m** > Value in meters
 < **ft** > Value in feet
-
- (7) < **CHARGE** > Charge indicator
 < **A** > Auto
 < **M** > Manual
-
- (8) < **Zoom** > Zoom indicator
 <  **WP** > Wide panel + bounce warning
 <  **WIDE** > Out of flash coverage range warning
-
- (9) Flash coverage (focal length)
-
- (10) Battery level indicator
-
- (11) <  > Flash exposure bracketing
-
- (12) FEB sequence
-
- (13) Flash exposure level
-
- (14) < **F** > Aperture value
-

* 1: The flash mode is identified after the indicator for the current Custom flash mode.

Manual flash (🔗)

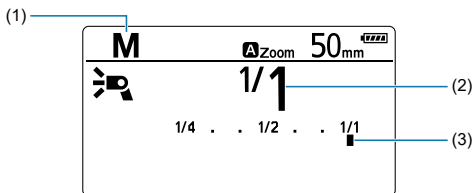

(1) < **M** > Manual flash
< **C1** > / < **C2** > / < **C3** > Custom flash mode*1

(2) Manual flash output

(3) Manual flash level

* 1: The flash mode is identified after the indicator for the current Custom flash mode.

Note

- These are only examples of display. Actual display only shows current settings.
- The LCD panel is illuminated in response to button or dial operations (🔗).

Stroboscopic flash (🔗)

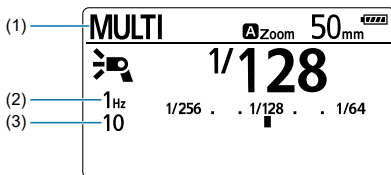

(1) < **MULTI** > Stroboscopic flash
< **C1** > / < **C2** > / < **C3** > Custom flash mode*1

(2) Flash frequency

(3) Flash count

* 1: The flash mode is identified after the indicator for the current Custom flash mode.

Radio transmission wireless flash photography (🔗)

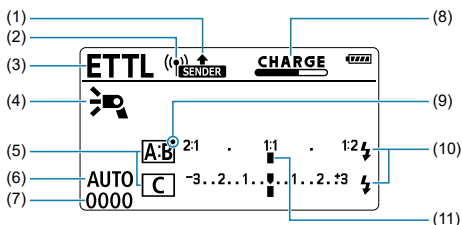

● Sender unit

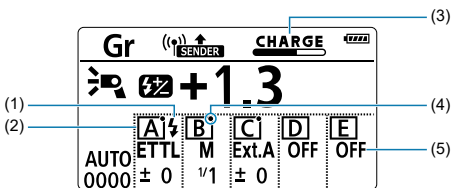

-
- (1) < **SENDER** > Configured as a sender
 < **SUB SENDER** > Configured as a sub-sender
-
- (2) < (📶) > Radio transmission wireless
-
- (3) Flash mode
 < **ETTL** > E-TTL II / E-TTL autoflash
 < **M** > Manual flash
 < **MULTI** > Stroboscopic flash
 < **Gr** > Group firing
 < **C1** > / < **C2** > / < **C3** > Custom flash mode*¹
-
- (4) < 📶 > Sender flash firing ON
 < 📶 > Sender flash firing OFF
-
- (5) Firing group control
-
- (6) < **Ch** > Transmission channel
 < **AUTO** > Transmission channel set automatically
-
- (7) Wireless radio ID
-
- (8) < **CHARGE** > Sender / receiver charge indicator
-
- (9) < ● > Modeling lamp indicator
-
- (10) < ⚡ > Receiver fully charged
-
- (11) Flash ratio

* 1: The flash mode is identified after the indicator for the current Custom flash mode.



-
- (1) <  > Receiver fully charged
-
- (2) Firing group control
-
- (3) Sender / receiver charge indicator
-
- (4) <  > Modeling lamp illumination
-
- (5) Group firing mode*¹
-

* 1: < **Gr** > Group firing only

Note

- < **CHARGE** > is no longer displayed after senders and receivers in radio transmission wireless flash photography are fully charged.
- < **ETTL** >, < **M** >, < **Ext.A** >, and < **OFF** > are available as flash modes for < **Gr** > group firing.
- As an indicator of modeling lamp illumination commands, <  > on firing group control information does not necessarily correspond to the current status of receiver modeling lamps.

● Receiver unit

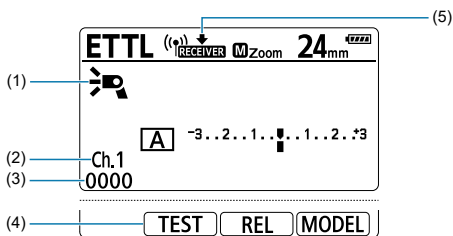

-
- (1) < > Receiver
-
- (2) < Ch > Transmission channel
-
- (3) Wireless radio ID
-
- (4) < **TEST** > Test flash
< **REL** > Remote release
< **MODEL** > Modeling flash
-
- (5) < **RECEIVER** > Configured as a receiver
-

Radio transmission: linked shooting (2)

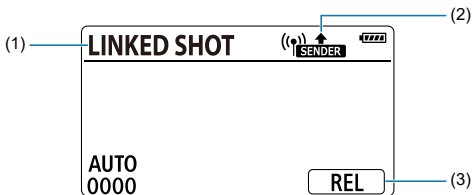

-
- (1) < **LINKED SHOT** > Linked shooting
< **C1** > / < **C2** > / < **C3** > Custom flash mode*¹
-
- (2) < **SENDER** > Configured as a sender
< **RECEIVER** > Configured as a receiver
-
- (3) < **REL** > Release*²
-

* 1: The flash mode is identified after the indicator for the current Custom flash mode.

* 2: < **SENDER** > Only when configured as a sender.

Battery Charger LC-E6 (Sold Separately)

Charger for Battery Pack LP-EL.

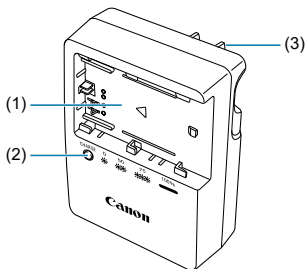

-
- (1) Battery slot

 - (2) Charge lamp

 - (3) Power plug

Battery Charger LC-E6E (Sold Separately)

Charger for the Battery Pack LP-EL.

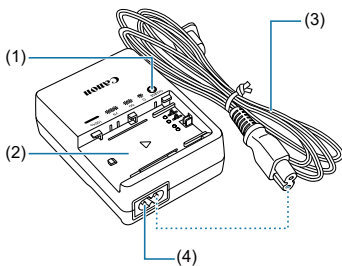

-
- (1) Charge lamp
 - (2) Battery pack slot
 - (3) Power cord
 - (4) Power cord socket
-

Included Accessories

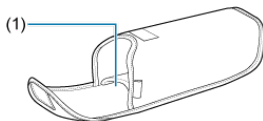

Speedlite case

(1) Mini stand storage pocket

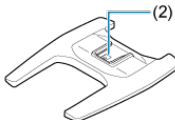

Mini stand

(2) Mounting part



Battery Pack LP-EL

Getting Started and Basic Operations

This chapter describes the preparations before starting flash photography and the basic shooting operations.

Caution

Precautions on continuous flash firing

- To avoid wearing out or damaging flash heads from overheating, do not fire the flash continuously at full output more than approx. 40 times. After firing continuously at full output this many times, stop using the Speedlite for at least 40 min.
- After continuous firing at full output this many times, further continuous firing at short intervals may activate a safety function that restricts firing. At a firing restriction level of 1, the firing interval is automatically set to approx. 8 sec. In this case, stop using the Speedlite for at least 40 min.
- For details, see [Flash Firing Restriction Due to Temperature Increase](#).

- [Charging the Battery](#)
- [Inserting the Battery](#)
- [Attaching and Detaching the Speedlite](#)
- [Turning on the Power](#)
- [Fully Automatic Flash Photography](#)
- [E-TTL II / E-TTL Autoflash, by Shooting Mode](#)
- [Checking Battery Information](#)

Charging the Battery

1. Remove the protective cover.

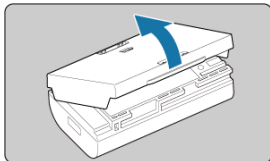

2. Fully insert the battery into the charger.

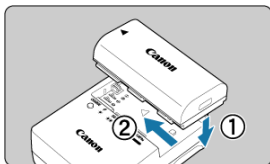

- Do the opposite to remove the battery.

3. Recharge the battery.

For LC-E6

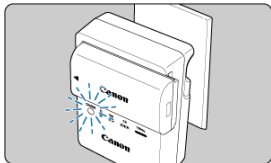
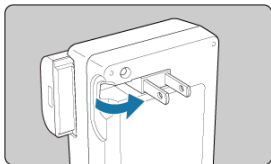

- As shown by the arrow, flip out the battery charger's prongs and insert the prongs into a power outlet.

For LC-E6E

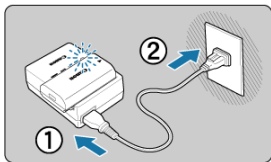

- Connect the power cord to the charger and insert the plug into a power outlet.
- Recharging starts automatically and the charge lamp blinks in orange.

Charge Level	Charge Lamp	
	Color	Display
0–49%	Orange	Blinks once per sec.
50–74%		Blinks twice per sec.
75% or higher		Blinks three times per sec.
Fully charged	Green	Remains lit

- **Charging a depleted battery takes approx. 2 hr. and 10 min. at room temperature (23°C/73°F).** Charging time varies greatly depending on ambient temperature and remaining capacity.

- For safety, charging in low temperatures (5–10°C/41–50°F) takes longer (up to approx. 4 hr.).
- **The Speedlite does not come pre-charged.**
Charge before use.
- **Charge on the day of use, or the day before.**
Batteries gradually lose their charge while in storage.
- **After charging the battery, remove it and unplug the charger.**
- **The protective cover can be attached facing certain directions to indicate charged or depleted status.**
Depending on the direction that you attach the cover, different colors are visible through the window (<  >). By deciding the colors to use for charged and depleted batteries and attaching the cover accordingly, you can see the battery status at a glance.

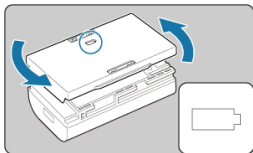

- **When the Speedlite is not in use, remove the battery.**
If the battery is left in the Speedlite over extended periods, the trace amount of current that continues to flow may lead to over-discharge and reduce the life of the battery. Store the battery with the protective cover attached. Note that storing the battery when it is fully charged may reduce its performance.
- **The battery charger can also be used in other countries.**
The charger is compatible with 100–240 V AC 50/60 Hz household power. If necessary, attach a commercially available plug adapter for the country or region. To avoid damage, do not connect to portable voltage transformers.
- **Batteries that lose their charge quickly despite being fully charged may need to be replaced.**
Check battery recharge performance before purchasing a new one.

Caution

- After unplugging the charger, do not touch the prongs for approx. 10 sec.
- Batteries are not charged unless the remaining capacity is lower than approx. 90%.



Note

Battery storage

- Store in a cool, dry, and well-ventilated place.
- Even if the battery is removed, the trace amount of current that continues to flow internally may eventually lead to over-discharge and prevent further use despite charging.
- Before extended storage, charge the battery to approx. 50% about once a year.

Inserting the Battery

Use Battery Pack LP-EL as the power source.

1. Open the cover.

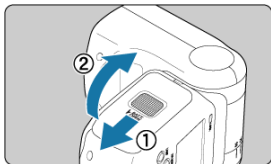

- Slide the battery compartment cover down to open it.

2. Insert the battery.

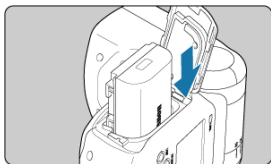

- Insert the battery contacts-first, as shown by the marking.

3. Close the cover.

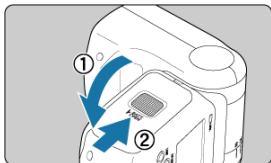

- Close the battery compartment cover and slide it up until it clicks into place.

Recharge time and flash count

EL-5 alone

Recharge Time		Flash Count
Quick Flash	Normal Flash	
Approx. 0.1–1.0 sec.	Approx. 0.1–1.2 sec.	Approx. 350–2,450

* The Quick flash function enables flash photography before the flash is fully charged (🔋).

* Using a new, fully charged Battery Pack LP-EL

* Based on Canon testing standards

Caution

- **After continuous flash firing, do not touch the flash head, battery, or near the battery compartment.**

After repeated use of continuous flash or modeling flash at short intervals, do not touch the flash head, battery, or near the battery compartment. The flash head, battery, and area near the battery compartment may become hot, which poses a risk of burns.

- **Do not allow the product to maintain contact with the same area of skin for extended periods of time during use.**

This may result in low-temperature contact burns, including skin redness and blistering, even if the product does not feel hot.

Note

- The battery should be charged when <  > is displayed, or if the LCD panel goes blank during flash recharging.

Attaching and Detaching the Speedlite

1. Attach the Speedlite.

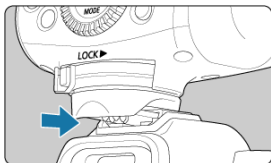

- Remove the camera shoe cover and Speedlite mounting foot cover.
- Insert the Speedlite slowly, making sure the Speedlite mounting foot is aligned with the camera multi-function shoe.
- Insert the Speedlite mounting foot **all the way** into the hot shoe.

2. Secure the Speedlite.

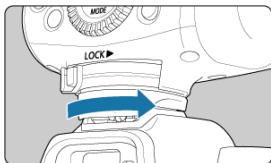

- Slide the mounting foot lock lever to the right.
- The lock lever is locked when it clicks into place.

3. Detach the Speedlite.

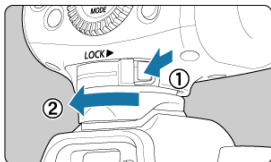

- While pressing the lock-release button, slide the lock lever left and remove the Speedlite.

 **Caution**

- Be sure to turn off the Speedlite before attaching or detaching it.
- Forcing the Speedlite onto a camera without a multi-function shoe may damage it or the camera.
- Do not allow hard objects to touch the contacts. This may damage the camera.
- Do not touch the contacts with your fingers. This may lead to corrosion. Corroded contacts may cause malfunctioning.
- Blow off any foreign material on the multi-function shoe with a commercially available blower or similar tool.
- Allow the multi-function shoe to dry before use if it gets wet.

Turning on the Power

- ☑ [Quick Flash](#)
- ☑ [Auto Power Off](#)
- ☑ [Locking Flash Operations](#)
- ☑ [LCD Panel Illumination](#)

1. Turn the power switch to <ON>.

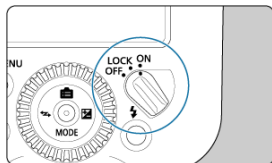

- Flash recharging begins.
- < **CHARGE** > appears on the LCD panel during recharging. After flash recharging, it is no longer displayed, and the Speedlite beeps.

2. Confirm that flash recharging is finished.

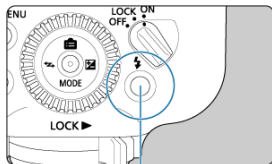

- The flash-ready lamp changes as follows: **off** → **red (blinking)** (Quick flash ready) → **red (lit)** (fully charged).
- To fire a test flash, press the test flash button (flash-ready lamp, (1)).

Caution

- Test flash firing is not available while a camera's metering timer is active.

Note

- Flash settings are retained even after the power is turned off.
- Beeping after flash recharging can be disabled in [P.Fn-05](#).

Quick Flash

Quick flash enables flash photography even when the flash-ready lamp is still blinking in red (before fully charged). It is available in all camera drive modes. Although flash output is limited to approx. 1/2 to 1/6 of full output, this feature is useful for shooting with a shorter firing interval.

In manual flash photography, Quick flash is available when the flash output is set to 1/4 to 1/1024. Note that Quick flash is not available when using stroboscopic flash or in wireless flash photography.

Caution

- Using Quick flash in continuous shooting may cause underexposure, due to the reduced flash output.

Note

- For details on < **CHARGE** > display when the Speedlite is set as a sender in radio transmission wireless flash photography, see [LCD Panel Illumination](#).
- Quick flash can be disabled in [P.Fn-01](#).

Auto Power Off

This feature conserves battery power by turning the Speedlite off automatically if it is left idle for approx. 90 sec. To restore power to the Speedlite, either press the camera shutter button halfway or press the test flash button (flash-ready lamp).

Auto power off takes effect in approx. 5 min. when the Speedlite is set as a sender in radio transmission wireless flash photography (☑) or configured for linked shooting (☑).



Note

- Auto power off can be disabled in [C.Fn-01](#).
- When attached to a camera, the Speedlite enters auto power off mode if left idle for approx. 90 sec. after the camera has entered auto power off mode.

Locking Flash Operations

Button and dial operations of the Speedlite can be disabled by setting the power switch to <LOCK>. This can help prevent accidentally changing the Speedlite settings. <LOCKED> is displayed on the LCD panel in response to button or dial operations.



Note

- Even with the power switch set to <LOCK>, test flash firing and modeling lamp illumination are available. Note that the LCD panel is illuminated in response to button or dial operations.

LCD Panel Illumination

The LCD panel is illuminated for approx. 12 sec. (⌚12) in response to button or dial operations.

For details on LCD panel illumination when the Speedlite is set as a sender in radio transmission wireless flash photography, see [LCD Panel Illumination](#).



Note

- LCD panel illumination can be changed in [C.Fn-22](#).

Fully Automatic Flash Photography

E-TTL II and E-TTL fully automatic flash shooting is available when the camera is set to <P> (Program AE) or fully automatic shooting mode.

1. Select <MODE> with the joystick.

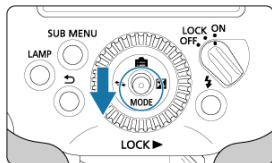

2. Select <ETTL>.

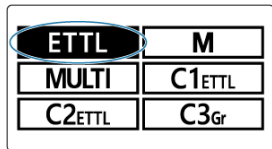

- Press the joystick vertically or horizontally or turn <⊙> to select <ETTL>, then push the joystick straight in.
3. Focus on the subject.
- Press the shutter button halfway to focus.
 - The shutter speed and aperture value are displayed in the viewfinder.
 - Confirm that <⚡> appears in the viewfinder.

4. Take the picture.

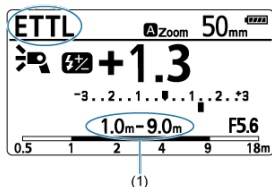

* This is an example of display when the camera is in < **P** > (Program AE) mode.

- Confirm that the subject is within the effective flash range (1).
- Pressing the shutter button completely fires the flash and takes a picture.

Note

- If the subject in your shot looks dark (underexposed), try approaching the subject before you shoot again. You can also try increasing the ISO speed.
- Fully automatic modes include < **A+** >, < **□** >, and < **CA** >.
- < **E-TTL** > is shown on the LCD panel, even when the Speedlite is used with cameras supporting E-TTL II.
- After shooting, turn off the camera and Speedlite, remove the Speedlite from the camera, and attach the mounting foot cover before storage.

E-TTL II / E-TTL Autoflash, by Shooting Mode

[Auto Zoom for Sensor Size](#)

[Transmission of Color Temperature Information](#)

[AF-Assist Beam](#)

E-TTL II or E-TTL autoflash suitable for the current shooting mode is used automatically – simply set the camera shooting mode to < **Tv** > (shutter-priority AE), < **Av** > (aperture-priority AE), < **Fv** > (flexible-priority AE), or < **M** > (manual exposure).

Tv	Select this mode when you want to set the shutter speed manually. The camera sets a suitable aperture value for the shutter speed to obtain standard exposure based on metering by the camera. <ul style="list-style-type: none">● Aperture values blink to warn about underexposed or overexposed backgrounds. Adjust the shutter speed until the aperture value stops blinking.
Av	Select this mode when you want to set the aperture value manually. The camera sets a suitable shutter speed for the aperture value to obtain standard exposure based on metering by the camera. <ul style="list-style-type: none">● Shooting with a tripod is recommended, because slow shutter speeds are used for low-light scenes.● Shutter speeds blink to warn about underexposed or overexposed backgrounds. Adjust the aperture value until the shutter speed stops blinking.
Fv	Any shutter speed or aperture value can be set. <ul style="list-style-type: none">● If the aperture value blinks when you set a shutter speed, adjust the shutter speed until the aperture value stops blinking.● If the shutter speed blinks when you set an aperture value, adjust the aperture value until the shutter speed stops blinking.
M	Select this mode if you want to set both the shutter speed and aperture value manually. Light from the flash provides standard exposure for subjects. Background exposure varies depending on your specified shutter speed and aperture value.

Flash sync speed and aperture value, by shooting mode

	Shutter Speed	Aperture Value
P	Set automatically (1/X sec. to 1/60 sec.)* ¹	Set automatically
Tv	Manually set (1/X sec. to 30 sec.)	Set automatically
Av	Set automatically (1/X sec. to 1/60 sec.)* ¹	Set manually
Fv	Set manually / automatically (at least 1/X sec.)	Set manually / automatically
M	Set manually (1/X sec. to 30 sec., Bulb)	Set manually

* 1/X sec. represents the camera's maximum flash sync shutter speed.

* 1: On cameras that support slow synchro, varies by settings.

Auto Zoom for Sensor Size

The Speedlite automatically recognizes the image sensor size of the EOS Digital camera and sets optimal flash coverage for the effective shooting angle of view of the lens in a focal length range of 24–200 mm.

Transmission of Color Temperature Information

This feature provides optimal white balance in flash photography by using color temperature information at the moment of firing, which is transmitted by the Speedlite to the EOS Digital camera. It is automatically enabled when camera white balance is set to < **AWB** >, < **AWB**W >, or <  >.

AF-Assist Beam

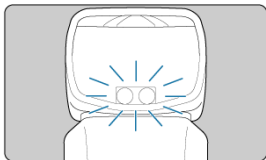

The Speedlite's built-in LED AF-assist beam automatically fires to assist with autofocusing in low-light scenes.

As for compatible angles of view, the AF-assist beam is effective for lens focal lengths of 24 mm and longer, and the effective range is approx. 0.6–10 m (2.0–32.8 ft.) at the center of the AF area.

⚠ Caution

- Focusing with the AF-assist beam of an external Speedlite may be difficult when using a peripheral AF point on the camera, or when using wide-angle or telephoto lenses. In this case, use the center AF point or an AF point near the center.

📄 Note

- AF-assist beam firing can be disabled in [C.Fn-08](#).
- Flash output is fixed for the EOS R3, EOS R7, and EOS R10. For other cameras with a multi-function shoe, flash output is automatically adjusted to suit brightness.
- Depending on ambient brightness, the AF-assist beam automatically switches to intermittent flash firing for the EOS R3, EOS R7, and EOS R10. For other cameras with a multi-function shoe, increases of internal temperature automatically reduce brightness of the LED AF-assist beam or switch to intermittent flash firing, for safety. Note that this beam may be emitted by the camera instead of by the Speedlite, depending on ambient brightness.

Checking Battery Information

You can check the status of the battery in use.

1. Press the <SUB MENU> button.

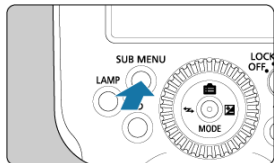

2. Display the information screen.

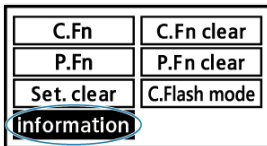

- Press the joystick vertically or horizontally or turn < Ⓞ > to select < **information** >, then push the joystick straight in.

3. Display the [Battery info.] screen.



- Press the joystick vertically or turn <  > to select < **Battery info.** >, then push the joystick straight in.

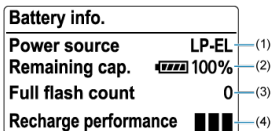

- (1) Identifies the battery in use.
- (2) Shows a battery level indicator and the remaining capacity as a percentage.
- (3) Shows a record of the current battery flash count, expressed as a full flash count. The count is reset after recharging.
- (4) Shows the battery recharge performance, indicating battery health.

: Recharge performance good

: Moderate

: Battery replacement recommended

Caution

- Using a genuine Canon Battery Pack LP-EL is recommended. Non-genuine batteries may not offer peak Speedlite performance, and they may lead to malfunctioning.

Note

- If the message [**Cannot communicate with battery Use this battery?**] appears, follow the instructions displayed.

Advanced Flash Photography

This chapter describes advanced shooting methods using Speedlite features.

Caution

- Features on pages with ☆ in the upper right are not available when the camera is in Full Auto or Basic Zone modes. All operations in this chapter are available with the camera shooting mode set to < **Fv** >, < **P** >, < **Tv** >, < **Av** >, < **M** > or < **Bulb (B)** > (Creative Zone).

- [Flash Exposure Compensation](#) ☆
- [Flash Exposure Bracketing](#) ☆
- [FE Lock](#) ☆
- [High-Speed Sync](#) ☆
- [Second-Curtain Sync](#) ☆
- [Bounce](#)
- [Flash Coverage Setting](#) ☆
- [Manual Flash](#) ☆
- [Stroboscopic Flash](#) ☆
- [Modeling Lamp](#)
- [Modeling Flash](#) ☆
- [Clearing Speedlite Settings](#) ☆

Flash output is adjustable. The amount of flash exposure compensation can be set in a range of ± 3 stops, in 1/3-stop increments.

1. Select  with the joystick.

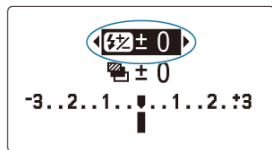
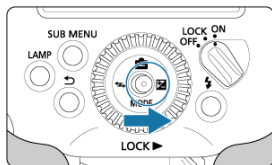

2. Set the flash exposure compensation amount.

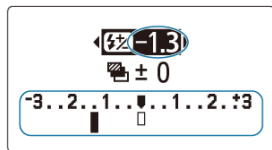
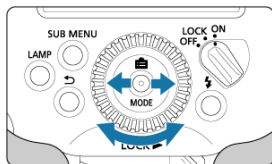

- Press the joystick horizontally or turn $\langle \odot \rangle$ to set the amount of compensation, then push the joystick straight in.
- "0.3" represents 1/3 stop and "0.7," 2/3 stop.
- To cancel flash exposure compensation, return the value to "±0."
- After you set a new value, it will not change if you press the joystick vertically.
- After changing the value, the changed value will not be set if the $\langle \curvearrowright \rangle$ button is pressed.

Note

- In general, use positive compensation for bright subjects and negative compensation for dark ones.
- When exposure compensation is set in 1/2-stop increments on the camera, flash exposure compensation is set in a range of ±3 stops in 1/2-stop increments.
- The Speedlite setting takes precedence if flash exposure compensation is set on both the Speedlite and the camera.
- You can set the flash exposure compensation amount by turning $\langle \odot \rangle$ directly without selecting $\langle \text{Fn} \rangle$ with the joystick ([C.Fn-13](#)).

You can take three shots while automatically changing the flash output. This feature is referred to as flash exposure bracketing (FEB). The setting range is ± 3 stops, in 1/3-stop increments.

1. Select  with the joystick.

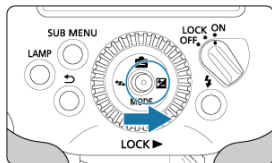

2. Press the joystick down to select FEB.

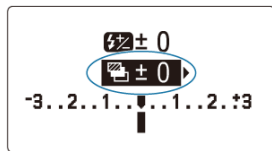

3. Set the FEB level.

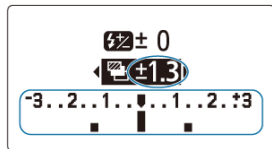
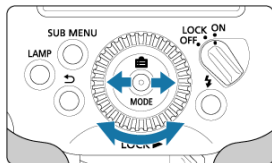

- Press the joystick horizontally or turn $\langle \odot \rangle$ to set the FEB level, then push the joystick straight in.
- "0.3" represents 1/3 stop and "0.7," 2/3 stop.
- When used with flash exposure compensation, FEB shooting is centered on your specified flash exposure compensation amount. $\langle \blacktriangleleft \rangle$ or $\langle \blacktriangleright \rangle$ appears at the ends of the indicator if the flash exposure level exceeds ± 3 stops.
- After you set a new value, it will not change if you press the joystick vertically.
- After changing the value, the changed value will not be set if the $\langle \blacktriangleleft \rangle$ button is pressed.

Note

- FEB is automatically canceled after the three shots are taken.
- Before shooting with FEB, consider setting the camera drive mode to single shooting, and confirm that flash recharging is finished. In continuous shooting drive mode, shooting automatically stops after three consecutive shots.
- You can use FEB together with flash exposure compensation or FE lock.
- When exposure compensation is set in 1/2-stop increments on the camera, flash exposure compensation is set in a range of ± 3 stops in 1/2-stop increments.
- You can disable auto cancellation of FEB after three shots in [C.Fn-03](#).
- You can change the FEB shooting sequence ([C.Fn-04](#)).

Shooting with flash exposure (FE) locked provides suitable flash exposure over your specified area of the subject.

With < **ETTL** > displayed on the LCD panel, press the camera's < * > (AE lock) button.

1. Focus on the subject.



2. Press the < * > button (16).



- Center the subject in the viewfinder, then press the camera's < * > button.
- The Speedlite fires a preflash and stores the flash output required for the subject.
- [FEL] appears in the viewfinder for about half a second.
- Each time you press the < * > button, the Speedlite fires a preflash and stores the flash output required at that time.

Note

- < ⚡ > blinks in the viewfinder if suitable exposure cannot be obtained with FE lock. Approach the subject or open the aperture, then try locking the flash exposure again. You can also try increasing the ISO speed before attempting FE lock again.
- FE lock may not be effective if the subject is too small on the screen.

High-speed sync enables flash photography at even higher shutter speeds than the maximum flash sync shutter speed. This is effective when shooting with an open aperture in < **Av** > (aperture-priority AE) mode to blur the background behind subjects outdoors in daylight, for example.

1. Push the joystick straight in.

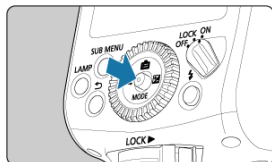

2. Select the item shown in (1).

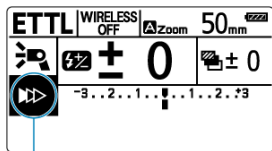



(1)

- Press the joystick vertically or horizontally or turn <  > to select the item, then push the joystick straight in.

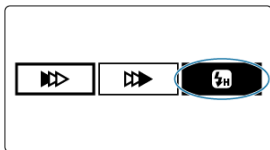
3. Select < >.





- Press the joystick horizontally or turn <  > to select <  >, then push the joystick straight in.
- Before shooting, confirm that <  > appears in the viewfinder.

Caution

- With high-speed sync, the faster the shutter speed, the lower the guide number. You can check the effective flash range on the LCD panel.
- To avoid wearing out or damaging the flash head from overheating, the Speedlite may reduce the continuous flash count in repeated shooting with high-speed sync.

Note

- <  > is not displayed in the viewfinder at shutter speeds slower than the maximum flash sync shutter speed.
- To return to normal flash firing, select <  > (first-curtain sync) in step 3 (<  > is not displayed on the screen after configuration).
- < SYNC > (shutter sync) can also be assigned to vertical or horizontal joystick positions in [P.Fn-08](#).

Using second-curtain sync at low shutter speeds enables natural shots of subject motion trails, such as car lights. The flash fires immediately before the camera finishes shooting (before the shutter closes).

1. Push the joystick straight in.

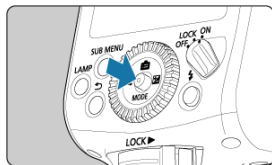

2. Select the item shown in (1).

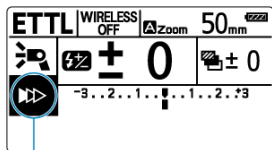

(1)

- Press the joystick vertically or horizontally or turn < Ⓞ > to select the item, then push the joystick straight in.

3. Select < ⏩ >.

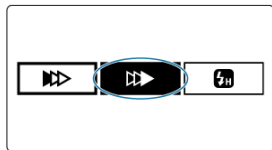

- Press the joystick horizontally or turn < Ⓞ > to select < ⏩ >, then push the joystick straight in.



Note

- Second-curtain sync works well in (Bulb) shooting mode.
- The Speedlite fires twice in <ETTL> flash mode. The first firing, which does not indicate malfunctioning, is preflash to determine flash output.
- To return to normal flash firing, select <▶▶> (first-curtain sync) in step 3 (<▶▶> is not displayed on the screen after configuration).





Bounce

 [< Flash > Close-Range Flash Photography](#)

 [Catchlight Shooting](#)

Pointing the flash head at a ceiling or wall to use the light reflected from it can soften subject shadows, enabling more natural-looking shots. This shooting method is referred to as bounce flash photography.

Setting the orientation of the flash head

- You can turn or tilt the flash head as shown. Turning or tilting the flash head changes the display to .
- With the Speedlite set to  (Auto) flash coverage, turning the flash head sets flash coverage to 50 mm, and  is displayed.
- You can also set the flash coverage manually ().

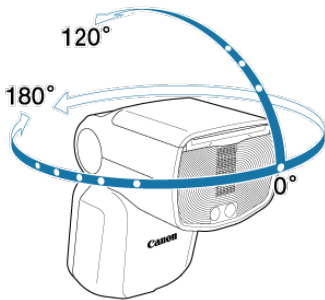

Note

- Bouncing light off ceilings or walls that are too far away may not provide sufficient exposure, because not enough light will reach the subject.
- If your shots are too dark, reduce the aperture value (f/number) to open the aperture and try again. You can also try increasing the ISO speed.
- Choose a plain white or off-white ceiling or wall to bounce the light off, because these are more reflective. Reflections off non-white surfaces may not provide sufficient exposure – not enough light may reach the subject, and your shots may be affected by the color of surface used.
- Using Quick flash in bounce flash photography is more likely to cause underexposure, from the reduced flash output.

< ƒ, P > Close-Range Flash Photography

You can shoot subjects at a close range of approx. 0.5–2 m (1.6–6.6 ft.) by tilting the flash head down 7°.

Tilting the flash head down by 7° changes the display to < ƒ, P >.

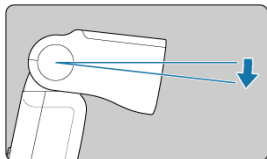

Note

- The following screen appears when the flash head is tilted down. If it was tilted accidentally, return it to the original position.



Catchlight Shooting

Using the catchlight panel when shooting a portrait enables you to capture reflected light in a person's eyes and create a more vivid expression.

1. Tilt the flash head up 90°.

2. Pull up the wide panel.

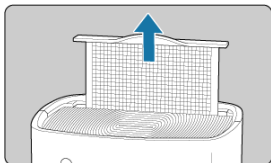

- Lift the tab in the middle of the wide panel.
- The white catchlight panel comes out with it.

3. Push back the wide panel.

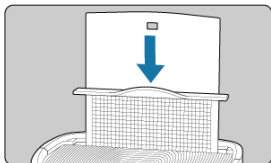

- Push back the wide panel by itself, leaving only the catchlight panel up.
- Shooting is the same as in normal bounce flash photography.

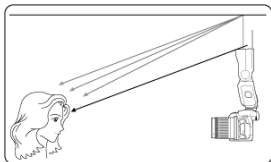

 **Caution**

- Position the flash head toward the front and 90° up. When the flash head is rotated to the left or right, the catchlight is not very effective.
- To effectively obtain the catchlight in a person's eyes, shoot within approx. 1.5 m / 4.9 ft. from the subject (at ISO 100 with f/2.8).
- Do not pull up the wide panel with excessive force. Doing so may detach the wide panel from the Speedlite.

[Wide Panel](#)

Flash coverage can be set automatically or manually. Set to < **A** > (Auto) for automatic adjustment of flash coverage to suit the focal length (shooting angle of view) of the attached lens and the size of the image sensor (). With < **M** > (Manual), you can manually set flash coverage in a range of 24–200 mm.

1. Push the joystick straight in.

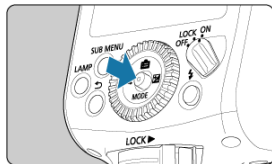

2. Select the item shown in (1).

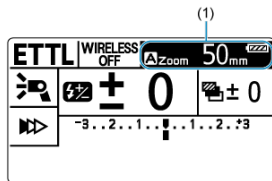

- Press the joystick vertically or horizontally or turn < > to select the item, then push the joystick straight in.

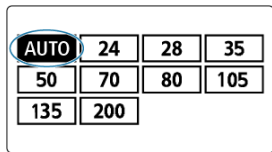

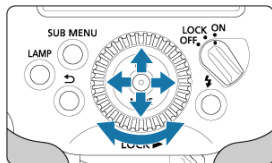

3. Set the flash coverage.



AUTO	24	28	35
50	70	80	105
135	200		

- Press the joystick vertically or horizontally or turn < Ⓞ > to select the flash coverage, then push the joystick straight in.
- To set automatically, select < **AUTO** >, and to set manually, select a value (focal length in mm).

Note

- Flash coverage that you set manually should match or exceed the shooting angle of view, to avoid vignetting.
- A <  **WIDE** > warning is displayed on the LCD panel when a lens with a focal length less than 24 mm is attached. Similarly, a <  **WIDE** > warning is displayed when you are using a camera with an image sensor smaller than full-frame and the actual shooting angle of view exceeds that of a 24 mm lens.
- < **ZOOM** > can also be assigned to vertical or horizontal joystick positions, in [P.Fn-08](#).

Wide Panel

The built-in wide panel enables flash photography covering the angle of view of an ultra wide-angle lens with a focal length of 14 mm.

1. Pull out the wide panel.

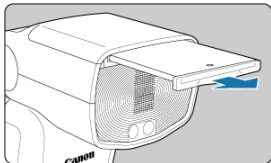

- Pull out the tab in the middle of the wide panel.
- The white catchlight panel comes out with it.

2. Push back the catchlight panel.

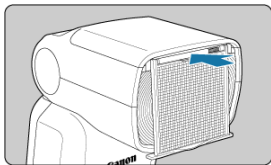

- Push back the catchlight panel by itself, leaving the wide panel down.

Caution

- A  **WP** > warning appears on the LCD panel when the wide panel is used in bounce flash photography, because underexposure is more likely to occur under these conditions.
- Do not pull out the wide panel with excessive force. This may detach it from the Speedlite.
- Not compatible with shooting angles of view from the EF15mm f/2.8 Fisheye or EF8-15mm f/4L Fisheye USM.

**Note**

- Flash coverage is set automatically when the wide panel is used. It cannot be changed manually.

☑ [Setting Manual Flash Output from FE Memory](#)

☑ [Metered Manual Flash Exposure](#)

Flash output can be set in a range of 1/1024 to full output (1/1), in 1/3-stop increments. By using a commercially available flash meter, you can determine the flash output required for suitable exposure. Setting the camera shooting mode to **<Av>** or **<M>** is recommended.

1. Select **<MODE>** with the joystick.

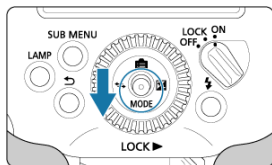

2. Set the flash mode to **<M>**.

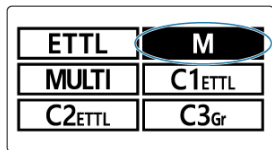

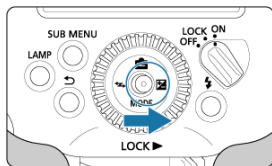

- Press the joystick vertically or horizontally or turn **<⊙>** to select **<M>**, then push the joystick straight in.

3. Select <  > with the joystick.

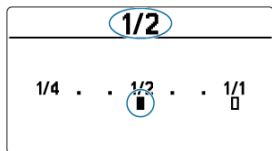

4. Set the flash output.



- Press the joystick horizontally or turn <  > to set the flash output, then push the joystick straight in.

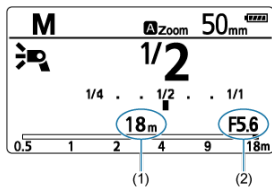

- The approximate shooting distance (1) and the aperture value (2) are displayed when you press the camera shutter button halfway.

 **Note**

- The flash output setting range is 1/128–1/1 when high-speed sync is set.
- For details on guide numbers when manual flash is used, see [Specifications](#).
- Flash output can also be set directly by turning <  > without first selecting < **MODE** > with the joystick, if you configure [C.Fn-13](#).

Setting Manual Flash Output from FE Memory

The flash output level used when shooting in <ETTL> flash mode can be applied as the level for <M> flash mode.

1. Set up the FE memory function.

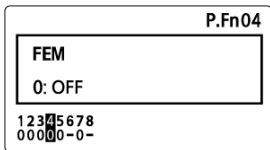

- In the personal functions, set P.Fn-04 <FEM> to [1] (ON, ) .

2. Shoot in <ETTL> flash mode.

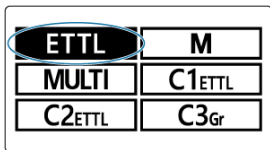

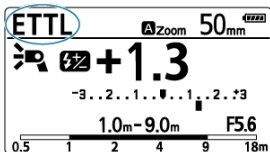

- Select <MODE> with the joystick.
- Press the joystick vertically or horizontally or turn <⊙> to select <ETTL>, then push the joystick straight in.

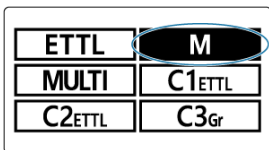

- Press the shutter button completely to shoot.

3. Set the flash mode to <M>.



- Select < **MODE** > with the joystick.
- Press the joystick vertically or horizontally or turn <  > to select < **M** >, then push the joystick straight in.

4. Check the flash output.

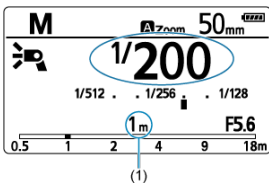

- Confirm that the subject is within the effective flash range (1).

Caution

- Before firing with the Speedlite set to < **ETTL** >, make sure the flash-ready lamp is red (fully charged).
- If you adjust the ISO speed, aperture value, or other settings that involve flash output (such as light intensity or flash zoom) after shooting with the Speedlite set to < **ETTL** >, we recommend shooting with it set to < **ETTL** > again.
- Color temperature of the Speedlite may differ greatly from that of the ambient light when the camera white balance is set to < **AWB** >, and color tones of shots may differ between < **ETTL** > and < **M** > settings when flash compensation is set to the negative side and [**E-TTL balance**] is set to [**Ambience priority**].
- When using FE memory in wireless multi-flash shooting, configure settings for < **ETTL** > and < **M** > firing groups identically in advance. When < **ETTL** > is set to < **A:B:C** >, set < **M** > to < **A:B:C** >.
- The effective flash range indicated for < **ETTL** > may not match the focus distance indicated for < **M** >, depending on shooting conditions.
- Setting flash output to 1/1024 may result in overexposure.

Note

- You can simply press the joystick down to switch between < **ETTL** > and < **M** > when P.Fn-04 < **FEM** > is set to [2] (ON / **MODE** **ETTL** ↔ **M**).

Metered Manual Flash Exposure

Using a camera compatible with metered manual flash, you can set the flash exposure level manually before shooting. This is effective in close-range flash photography. Use a standard 18% gray reflector (commercially available) and shoot as follows.

1. Configure the camera and Speedlite settings.

- Set the camera shooting mode to **<M>** or **<Av>**.
- Set the Speedlite flash mode to **<M>**.

2. Focus on the subject.

- Focus on the subject manually.

3. Set up the 18% gray reflector.

- Place it at the position of the subject.
- Aim the camera so that the reflector fills the entire spot metering circle in the viewfinder.

4. Press the **<M-Fn>** or **<✳>** / **<FEL>** button (ⓘ16).

- The Speedlite fires a preflash and stores the flash output required for suitable flash exposure.
- On the right side of the viewfinder, the exposure level indicator shows the flash exposure level relative to standard exposure.

5. Set the flash exposure level.

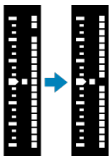

- Adjust the Speedlite's manual flash output to align the flash exposure level with the standard exposure index.

6. Take the picture.

- Remove the gray reflector and take the picture.



Note

- Refer to camera instruction manuals for details on cameras that are compatible with metered manual flash.

☑ [Calculating the Shutter Speed](#)

Using stroboscopic flash at low shutter speeds enables you to capture continuous movement in a single shot, as in sequential photography.

For stroboscopic flash, set the flash output, flash count, and flash frequency (flash count per second, equivalent to Hz). For details on the maximum continuous flash count, see [Maximum continuous flash count](#).

1. Select **<MODE>** with the joystick.

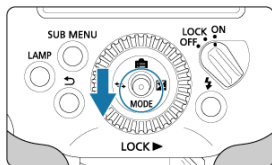

2. Set the flash mode to **<MULTI>**.

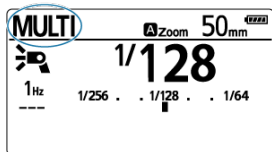
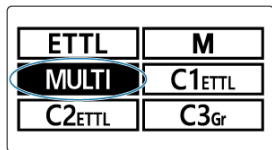

- Press the joystick vertically or horizontally or turn **<⊙>** to select **<MULTI>**, then push the joystick straight in.

3. Push the joystick straight in, then select an item.

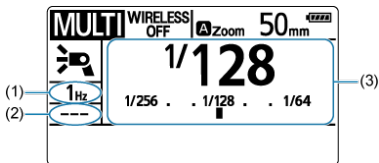
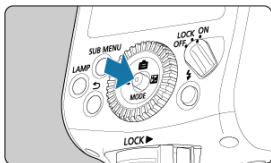

- Press the joystick vertically or horizontally or turn the \odot to select the flash frequency (1), flash count (2), or flash output (3), then push the joystick straight in.

4. Set the value.

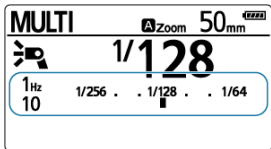
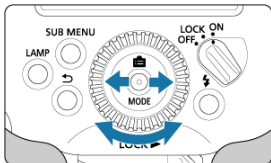

- Press the joystick horizontally or turn \odot to set the value, then push the joystick straight in.
- Repeat steps 3–4 until the flash frequency, count, and output are all configured.

Calculating the Shutter Speed

To ensure that the shutter remains open until all stroboscopic firing is finished, calculate a shutter speed to set on the camera as follows.

Flash count ÷ flash frequency = shutter speed

For example, when flash count is set to 10 (times) and flash frequency to 5 (Hz), set the shutter speed to at least 2 sec.

Caution

- To avoid wearing out or damaging flash heads from overheating, do not use stroboscopic flash repeatedly more than 30 times. After 30 times, stop using the Speedlite for at least 10 min.
- Shooting more than 30 times may activate a safety function and restrict flash firing. In this case, stop using the Speedlite for at least 40 min.

Note

- Stroboscopic flash is most effective for highly reflective subjects against a dark background.
- Using a tripod and remote switch is recommended.
- Flash output cannot be set to 1/1 or 1/2.
- Stroboscopic flash is also available when the camera is in <Bulb (**B**)> shooting mode.
- A flash count display of “----” indicates that the Speedlite will fire continuously until the shutter closes or the charge runs out, with the maximum flash count as listed in [Maximum continuous flash count](#).
- High-speed sync () is not available with stroboscopic flash.

Maximum continuous flash count

Maximum flash count is as follows when the flash count is indicated as "----" (bar display).

Flash Output / Hz	1	2	3	4	5	6-7	8-9
1/4	7	6	5	4	4	3	3
1/8	14	14	12	10	8	6	5
1/16	30	30	30	20	20	20	10
1/32	60	60	60	50	50	40	30
1/64	90	90	90	80	80	70	60
1/128	100	100	100	100	100	90	80
1/256	100	100	100	100	100	100	100
1/512	100	100	100	100	100	100	100
1/1024	100	100	100	100	100	100	100

Flash Output / Hz	10	11	12-14	15-19	20-50	60-199	250-500
1/4	2	2	2	2	2	2	2
1/8	4	4	4	4	4	4	4
1/16	8	8	8	8	8	8	8
1/32	20	20	20	18	16	12	10
1/64	50	40	40	35	30	20	15
1/128	70	70	60	50	40	40	30
1/256	100	100	100	100	80	80	60
1/512	100	100	100	100	100	100	100
1/1024	100	100	100	100	100	100	100

Modeling Lamp

Pressing the **<LAMP>** button illuminates the modeling lamp for 5 min. To turn it off, press the button again.

This is useful for checking subject shadows created by the Speedlite.

Pressing the camera shutter button completely turns off the modeling lamp.

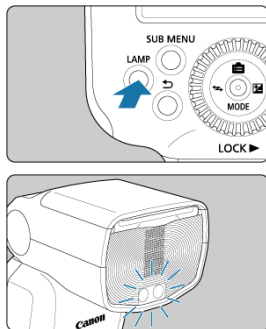

Caution

- Avoid looking directly at the modeling lamp at close range, which may cause visual impairment.
- Shooting with the modeling lamp on from a camera in **<M>** shooting mode may cause underexposure.
- When the flash does not fire, such as when the flash is disabled or when shooting a movie, the modeling lamp does not turn off automatically even if you press the shutter button fully.
- A warning appears when the modeling lamp becomes hot (🔥).
- The modeling lamp may dim or turn off if the ambient temperature around it becomes too high.

Note

- You can change how the modeling lamp is activated in [C.Fn-18](#).
- Brightness of the modeling lamp can be adjusted in [P.Fn-06](#).
- You can select how long the modeling lamp remains on in [P.Fn-07](#).
- The light is dimmer when a wide panel is used.
- The modeling lamp of connected sender/receiver units (📡) turns on and off in response to pressing the **<LAMP>** button when the Speedlite is a sender in radio transmission wireless flash photography.

The flash fires continuously for approx. 1 sec. in response to pressing the DOF preview button on the camera when cameras other than models in the EOS R or EOS M series are used as a sender with the EL-5 as a receiver. This feature is referred to as modeling flash. It is useful for checking subject shadows created by the Speedlite, as well as the balance of lighting in wireless flash photography (📷).

1. Press the depth-of-field preview button on the camera.

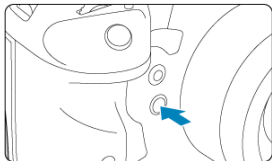

- The Speedlite fires continuously for approx. 1 sec.

⚠ Caution

- To avoid wearing out or damaging flash heads from overheating, do not fire the modeling flash more than 40 times. After firing the modeling flash 40 times, stop using the Speedlite for at least 40 min.
- After firing modeling flash this many times, further continuous firing at short intervals may activate a safety function that restricts firing. At a firing restriction level of 1, the firing interval is automatically set to approx. 8 sec. In this case, stop using the Speedlite for at least 40 min.

You can restore default settings for Speedlite shooting functions, wireless shooting, and Custom flash modes.

1. Press the <SUB MENU> button.

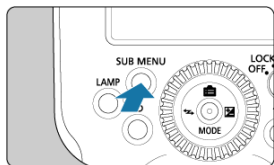

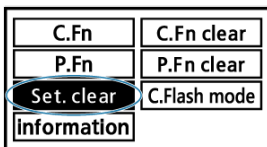

2. Select <Set. clear>.

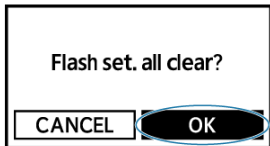
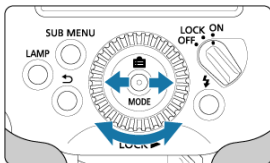

- Press the joystick vertically or horizontally or turn <⊙> to select <Set. clear>, then push the joystick straight in.

3. Clear the settings.



- Press the joystick horizontally or turn <  > to select < **OK** >, then push the joystick straight in.
- The Speedlite settings are cleared, preparing it for normal flash photography in < **ETTL** > flash mode.

Note

- Clearing the settings does not clear the radio channel or wireless radio ID for wireless flash photography, Custom/Personal Functions (C.Fn/P.Fn) settings, or Custom flash mode settings (except settings for auto updating and camera mode linkage).

Setting Flash Functions from the Camera

This chapter describes how to configure flash functions from the camera menu.

Caution

- Operations described in this chapter are not available when the camera is in Full Auto or Basic Zone modes. Set the camera's shooting mode to < **Fv** >, < **P** >, < **Tv** >, < **Av** >, < **M** >, or < **Bulb (B)** > (Creative Zone).

- [Flash Control from the Camera Menu](#)

Flash Control from the Camera Menu

[Flash Function Settings](#)

[Settings Available on the Flash Function Settings Screen](#)

[Flash C.Fn Settings](#)

You can set flash functions and Custom Functions from the camera menu. If Custom Functions on the Speedlite are not displayed on the camera, try updating the camera firmware, or set them from the Speedlite.

For camera instructions, refer to the camera instruction manual.

1. Select **<  >** with the joystick.

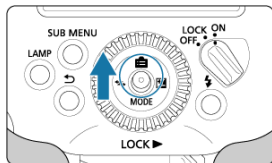

- A menu is displayed on the camera.

2. Set the function.

- The setting screen and items displayed vary depending on the camera.
- Select an item and set the function.

Example of display

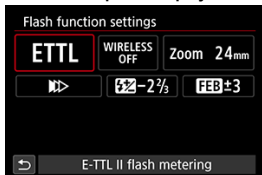

Settings Available on the Flash Function Settings Screen

On the camera's **[Flash function settings]** or **[External flash func. setting]** screen, you can configure settings for normal flash photography or radio transmission wireless flash photography.

Main functions you can configure are as follows. Available settings vary depending on flash mode, wireless function settings, and other conditions.

Function	
Flash firing	Enable / Disable
E-TTL balance	Ambience priority / Standard / Flash priority
E-TTL II meter.	Eval (FacePrty) / Evaluative / Average
Contin flash ctrl	E-TTL each shot / E-TTL 1st shot
Slow synchro	
Flash mode	E-TTL II flash metering (autoflash) / Manual flash / MULTI flash (stroboscopic)
Wireless functions	Wireless:Off / Radio transmission
Flash zoom (flash coverage)	
Shutter synchronization	First-curtain synchronization / Second-curtain synchronization / High-speed synchronization
Flash exposure compensation	
Flash exposure bracketing	

● Flash firing

To enable flash photography, set to **[Enable]**. To enable only the AF-assist beam of the Speedlite, set to **[Disable]**.

● E-TTL balance

You can set your preferred appearance (balance) for flash shots. This setting enables you to adjust the ratio of ambient light to Speedlite light output.

● E-TTL II meter.

Set to **[Eval (FacePrty)]** for flash metering suitable for shots of people. High-speed continuous shooting is slower than when **[Evaluative]** or **[Average]** is selected. Set to **[Evaluative]** for flash metering that emphasizes firing in continuous shooting. If **[Average]** is set, flash exposure is averaged for the entire metered scene. Depending on the scene, flash exposure compensation may be necessary.

- **Contin flash ctrl**

Set to **[E-TTL each shot]** to perform flash metering for each shot. Set to **[E-TTL 1st shot]** to perform flash metering for only the first shot before continuous shooting. The flash output level for the first shot is applied to all subsequent shots. Useful when prioritizing continuous shooting speed without recomposing shots.

- **Slow synchro**

You can set the flash-sync speed for flash photography in **< Av >** (aperture-priority AE) mode.

- **Flash mode**

You can choose the flash mode from **[E-TTL II flash metering]**, **[Manual flash]**, or **[MULTI flash (stroboscopic)]** to suit your desired flash photography.

- **Wireless functions**

You can set up radio transmission wireless flash photography. For details, see [Radio Transmission Wireless Flash Photography](#).

- **Flash zoom (flash coverage)**

You can set the Speedlite flash coverage. Set to **[Auto]** for automatic configuration of flash coverage to suit the lens focal length and image sensor size (🔗).

- **Shutter synchronization**

As the flash firing timing/method, you can choose from **[First-curtain synchronization]**, **[Second-curtain synchronization]**, or **[High-speed synchronization]**. For normal flash photography, set to **[First-curtain synchronization]**.

- **Flash exposure compensation**

Just as exposure compensation is adjusted, you can also adjust flash output. The amount of flash exposure compensation can be set in a range of ± 3 stops, in 1/3-stop increments.

- **Flash exposure bracketing**

Enables automatic adjustment to different flash output levels as three shots are taken at once. The setting range is ± 3 stops, in 1/3-stop increments.

- **Clear settings**

Select **[Clear flash settings]** or **[Clear external flash set.]** to restore Speedlite settings to defaults.

 **Caution**

- **[Flash zoom]** (flash coverage) is not available when flash coverage is automatically set, as when the wide panel is used.

 **Note**

- Flash exposure compensation cannot be performed from the camera when it is set on the Speedlite. If both are set at the same time, the Speedlite setting takes precedence.

Flash C.Fn Settings

You can set Custom Functions for the Speedlite from the camera menu. The information displayed varies depending on the Speedlite used. For details on Custom Functions, see [Customization with Custom Functions](#).

1. Select [Flash C.Fn settings].

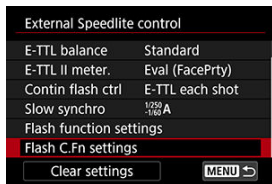

- Select [Flash C.Fn settings] or [External flash C.Fn setting].

2. Set the Custom Function.

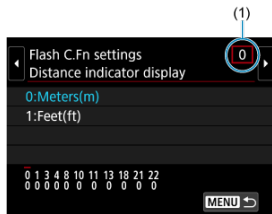

- Select the Custom Function number (1), then set the function.

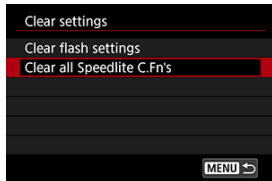

- To clear all the Custom Function settings, select [Clear settings] in step 1, then select [Clear all Speedlite C.Fn's] or [Clear ext. flash C.Fn set.].

 Caution

- Personal Functions ([P.Fn](#)) cannot be set or collectively cleared from the camera menu screen. Set them on the Speedlite.

Radio Transmission Wireless Flash Photography

This chapter describes radio transmission wireless flash photography using sender and receiver functionality.

For details on Speedlites compatible with this wireless flash photography, refer to the Supplemental Information ()

Caution

- Operations described in this chapter are not available when the camera is in Full Auto or Basic Zone modes. Set the camera's shooting mode to < **Fv** >, < **P** >, < **Tv** >, < **Av** >, < **M** >, or < **Bulb (B)** > (Creative Zone).
- When it is important to maintain the wireless connection, do not operate the power switch or move parts such as the battery compartment cover. The wireless connection will be terminated.

Note

- The EL-5 attached to the camera is referred to as a "sender," and other Speedlites controlled wirelessly are referred to as "receivers."
- The EL-5 also supports remote release (remote shooting) from a receiver () . For details, refer to the instruction manual of a Speedlite equipped with remote release functionality.

- [Radio Transmission Wireless Flash Photography](#)
- [Wireless Settings](#)
- [Autoflash with One Receiver](#)
- [Autoflash with Two Receiver Groups](#)
- [Autoflash with Three Receiver Groups](#)
- [Wireless Multiple-Flash Photography with Flash Ratio](#)
- [Shooting in Group-Specific Flash Modes](#)
- [Firing Test Flash/Modeling Flash from Receivers](#)
- [Remote Release from Receivers](#)
- [Linked Shooting](#)

Radio Transmission Wireless Flash Photography

- [Positioning and Range](#)
- [Group Control](#)
- [Restrictions for Specific Cameras](#)

Shooting with wireless lighting from multiple flash units is as easy as normal E-TTL II / E-TTL autoflash shooting when you use Canon Speedlites supporting radio transmission wireless flash photography.

The system is designed so that the settings of the EL-5 (sender) are automatically applied to wirelessly controlled Speedlites (receivers). This eliminates the need to operate receivers during shooting.

Positioning and Range

- Autoflash with one receiver (📷)

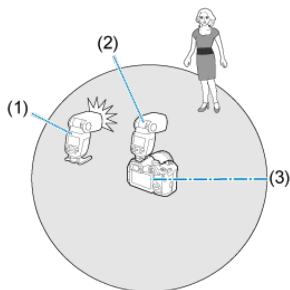

- (1) **RECEIVER** EL-5
- (2) **SENDER** EL-5
- (3) Transmission range: Approx. 30 m / 98.4 ft.

● **Autoflash with groups of receivers** (🔗, 📷)

E-TTL II / E-TTL autoflash photography is possible with two or three receiver groups, and the flash ratio (proportion of flash output) can be adjusted as needed.

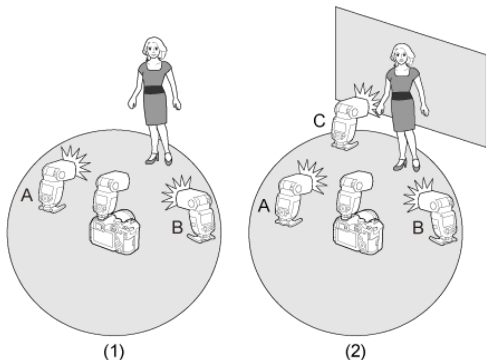

(1) 2 groups (A, B)

(2) 3 groups (A, B, C)

⚠ Caution

- Take a few test shots in advance, and test flash firing (📷).
- Transmission range may be shorter depending on factors such as Speedlite positioning, the surrounding environment, and weather conditions.

📄 Note

- Set up receivers using the included mini stand.

- Shooting in a different flash mode for each group (🔗)

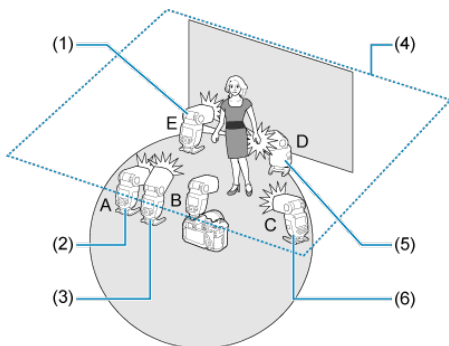

* This is only one example of flash mode settings.

- (1) E-TTL II
- (2) E-TTL II
- (3) Manual flash
- (4) Ceiling
- (5) Manual flash
- (6) Manual flash

Group Control

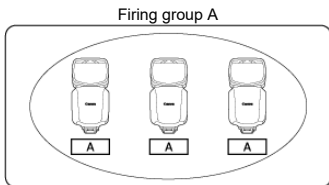

You can add receivers when more light or sophisticated lighting is needed. For added receivers, simply specify the firing group (A, B, or C) that you want to be brighter. For example, when three receivers are set to firing group < **A** >, they are all controlled as a single, high-output Speedlite in group A.

Caution

- To fire the three groups of A, B, and C, set to < **A:B:C** >. Group C does not fire when Speedlites are set to < **A:B** >.
- Aiming the units in firing group C directly at subjects may cause overexposure.

Note

- Flash ratios from 8:1 to 1:1 to 1:8 correspond to 3:1 to 1:1 to 1:3 (in 1/2-stop increments) as converted to number of stops.

Restrictions for Specific Cameras

Using a Speedlite other than the EL-5 as the sender may limit the functions available in radio transmission wireless flash photography. For details on available functions, refer to the instruction manual of the Speedlite used as the sender.

Wireless Settings

- [Setting as Sender](#)
- [Setting as Receiver](#)
- [Setting the Transmission Channel / Wireless Radio ID](#)
- [≤ LINK > Lamp and Connection Indicator](#)
- [Sender Flash Firing On / Off](#)
- [Modeling Lamp Wireless On / Off](#)

Set the sender and receiver for radio transmission wireless flash photography with E-TTL II / E-TTL autoflash as follows.

Setting as Sender

1. Select < ⚡ > with the joystick.

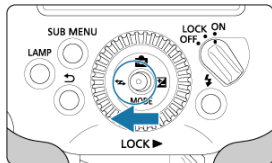

2. Set to < ((⚡)) **SENDER** >.

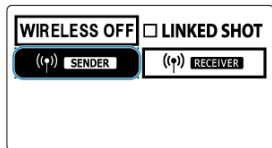

- Press the joystick vertically or horizontally or turn < ((⚡)) > to select < ((⚡)) **SENDER** >, then push the joystick straight in.

3. Select the firing method.

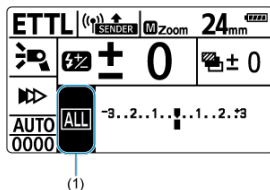

- Push the joystick straight in.
- Press the joystick vertically or horizontally or turn < Ⓞ > to select item (1), then push the joystick straight in.
- Press the joystick horizontally or turn < Ⓞ > to choose from < ALL >, < A:B >, or < A:B C >, then push the joystick straight in.

Setting as Receiver

1. Set to < ((☉)) **RECEIVER** >.

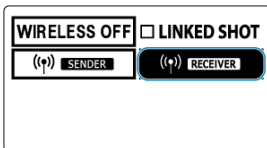

- Configure this setting on Speedlites to use as receivers.
- Select < ((☉)) **RECEIVER** > just as you set up the sender.

! Caution

- Before normal flash photography, select < **WIRELESS OFF** > to clear the wireless (sender/receiver) settings.

Setting the Transmission Channel / Wireless Radio ID

Set the sender's transmission channel and wireless radio ID as follows. **Set the same channel and ID for both the sender and receivers.** For receiver instructions, refer to the instruction manual of Speedlites equipped with radio transmission wireless receiver functionality.

⚠ Caution

- Set different wireless radio IDs for each channel, because interference between systems with Speedlites controlled by radio transmission may occur even if the units are set to different transmission channels.

1. Push the joystick straight in.

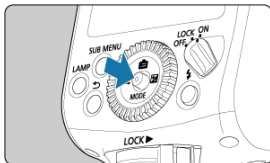

2. Select item (1).

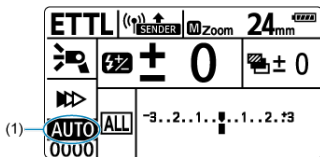

- Press the joystick vertically or horizontally or turn \odot to select the channel item, then push the joystick straight in.

3. Set a transmission channel.

AUTO	1	2	3
4	5	6	7
8	9	10	11
12	13	14	15

- Press the joystick vertically or horizontally or turn < Ⓢ > to choose from < **AUTO** > or channels 1–15, then push the joystick straight in.

4. Select item (2).

ETTL	(*) SENDER	M Zoom	24mm
🔦	⚡	±	0
▶▶			± 0
AUTO	ALL	-3..2..1..0..1..2..3	
(2) 0000			

- Select the ID item just as you set the transmission channel, then push the joystick straight in.

5. Set the wireless radio ID.

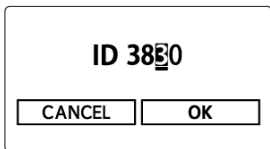

- Press the joystick horizontally or turn < Ⓞ > to select the position (digit) to set, then push the joystick straight in.
- Press the joystick vertically or turn < Ⓞ > to select a number in the range 0–9, then push the joystick straight in.
- Set a 4-digit number the same way, then select < **OK** >.

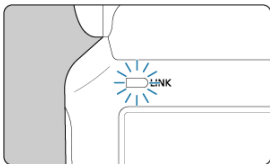

- The < **LINK** > lamp is lit in green when communication is established between the sender and receiver.

Scanning and setting sender transmission channels

You can scan radio signal conditions and then set the sender transmission channel automatically or manually. Setting the channel to [AUTO] will automatically reset the Speedlite to the channel with the strongest signal. When setting the channel manually, you can review scan results as you reset it.

● Scanning when currently set to [AUTO]

1. Press the <SUB MENU> button.

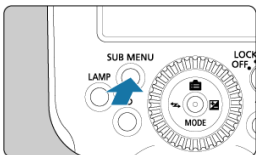

2. Run the scan.

C.Fn	C.Fn clear
P.Fn	P.Fn clear
Set. clear	C.Flash mode
information	SCAN

- Press the joystick vertically or horizontally or turn < Ⓞ > to select < **SCAN** >, then push the joystick straight in.
- Select < **OK** >.
- The scan is performed, and the setting is reset to the channel with the strongest signal.

● Scanning when currently set to a channel (1–15)

1. Press the <SUB MENU> button.

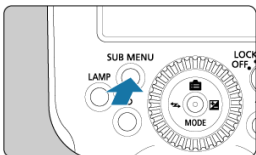

2. Run the scan.

- Press the joystick vertically or horizontally or turn < Ⓞ > to select < **SCAN** >, then push the joystick straight in.
- Select < **OK** >.
- The scan is performed, and a graph of signal conditions is displayed.
- Higher peaks in the graph indicate stronger signals.

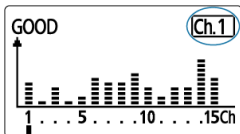

3. Set the channel.

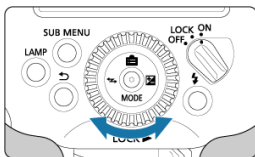

- Press the joystick horizontally or turn < Ⓞ > to choose a channel in the range of 1–15.
- Push the joystick straight in to set the channel.

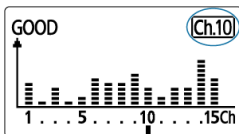

<LINK > Lamp and Connection Indicator

You can determine the connection status from the state of the <LINK > lamp or the icon on the LCD panel.

Status	Description	Action
Lit	Connected	—
Off	Not connected	Check the channel and ID
Off	Too many units	Do not exceed 16 senders and receivers, combined
Off	Error	Restart the senders and receivers
Lit	Connected* ¹	—
Lit	Connected* ²	—

* 1: When the sender side is connected to the sub-sender

* 2: When the sender side is connected for linked shooting

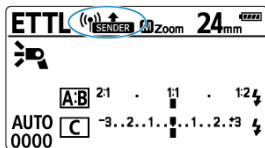

Display	Description	Action
	Connected	—
	Not connected	Check the channel and ID
	Too many units	Do not exceed 16 senders and receivers, combined
	Error	Restart the senders and receivers
	Connected* ¹	—

* 1: When the sender side is connected to the sub-sender

⚠ Caution

- Receivers do not fire unless the sender and receiver channels match. Set both to the same number, or set both to [AUTO].
- Receivers do not fire unless the sender and receiver wireless radio IDs match. Set to the same number.

Sender Flash Firing On / Off

You can set whether the sender fires along with the receivers it controls wirelessly. When sender flash firing is enabled, the sender fires as firing group A.

1. Push the joystick straight in.

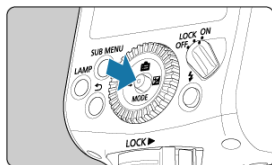

2. Select the item shown in (1).

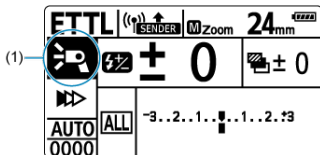

- Press the joystick vertically or horizontally or turn < Ⓞ > to select the item, then push the joystick straight in.

3. Set sender flash firing.

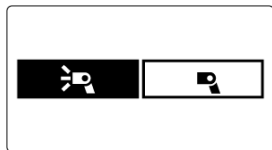

- Press the joystick horizontally or turn < Ⓞ > to enable or disable sender flash firing, then push the joystick straight in.
 - < ⚡ >: Sender flash firing ON
 - < 📷 >: Sender flash firing OFF



Note

- Disabling sender flash firing expands the available flash output range from 1/1024 to 1/8192.

Modeling Lamp Wireless On / Off

The modeling lamp of connected sender/receiver units turns on and off in response to pressing the sender <LAMP> button when the EL-5 is a sender or receiver. This way, you can check subject shadows created by multiple Speedlites simply by operating the sender. Pressing the sender camera shutter button completely also turns off the modeling lamp of receivers.

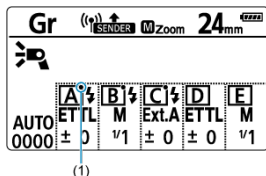

Caution

- When sender flash firing is disabled, the <LAMP> button does not activate the sender modeling lamp.
- Modeling lamps of firing groups set to <OFF> flash mode and other non-firing groups are not activated.
- Any changes to flash modes or firing groups while a modeling lamp is on do not alter the current illumination status of the lamp. Before changing these settings, turn off the sender modeling lamp as needed.

Note

- Receiver modeling lamps can be turned on or off even by a sub-sender.
- Brightness and duration of modeling lamp illumination depends on the settings of each receiver.
- As an indicator of modeling lamp illumination commands, <●> (1) on firing group control information does not necessarily correspond to the current status of receiver modeling lamps.

Autoflash with One Receiver

- [LCD Panel Illumination](#)
- [Flash Photography Applying Wireless Features](#)
- [Using Multiple Senders](#)

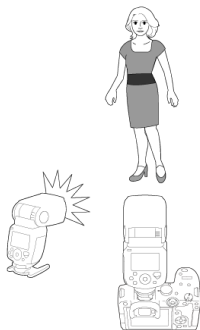

This section describes basic fully automatic wireless shooting with an EL-5 attached to the camera as a sender and an EL-5 set as a receiver.

1. Set up a unit as the sender.

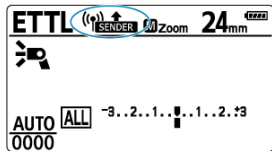

- Set the EL-5 attached to the camera as a sender (🔗).
- You can also use other devices equipped with radio transmission wireless sender functionality as senders.

2. Set up a unit as the receiver.

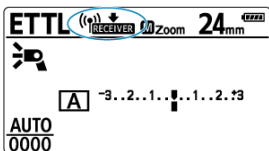

- Set the EL-5 for wireless control by the sender as the receiver (🔗).
- You can also use other Speedlites equipped with radio transmission wireless receiver functionality.

3. Check the channel and ID.

- Set the same transmission channel and wireless radio ID on senders and receivers, if they are different (🔗).

4. Position the camera and other Speedlite.

- Position them within the range shown in [Positioning and Range](#).

5. Use the joystick on the sender to select <MODE>.

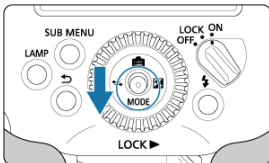

6. Set the flash mode to <ETTL>.

ETTL	M
MULTI	Gr
C1ETTL	C2ETTL
C3Gr	

- Press the joystick vertically or horizontally or turn <⊙> to select <**ETTL**>, then push the joystick straight in.
- The receiver is automatically set to <**ETTL**> during shooting, as controlled by the sender.
- Confirm that firing group control is set to <**ALL**>.

7. Check the connection and make sure the flash units are charged.

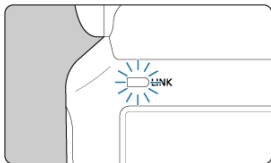

- Confirm that the < **LINK** > lamp is lit in green.

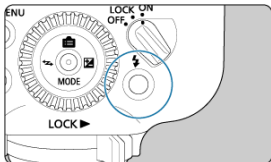

- Confirm that the sender and receiver flash-ready lamps are lit.
- The sender beeps after all Speedlites have been recharged when P.Fn-05 is set to [0] (🔋).

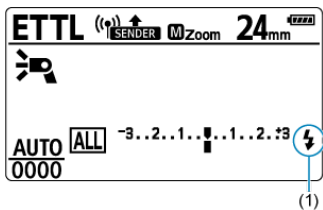

- Confirm that the < 🔋 > icon (1) indicating completion of sender/receiver charging appears on the sender LCD panel (< **CHARGE** > is not displayed).
- For details on sender LCD panel illumination, see [LCD Panel Illumination](#).

8. Check operation.

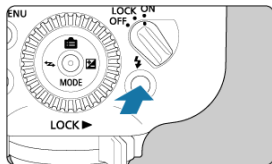

- Press the sender test flash button.
- The Speedlites fire. If it does not fire, confirm that it is within transmission range (📶).

9. Take the picture.

- Just as in normal flash photography, shoot after configuring the camera.

⚠ Caution

- Radio transmission is not possible unless the < **LINK** > lamp is lit. Double-check the transmission channels and wireless radio IDs of senders and receivers. If you cannot connect with the same settings, restart the senders and receivers.

📄 Note

- Flash coverage of the sender and receiver is set to 24 mm. You can also set the flash coverage manually.
- The sender can also fire (📶).
- You can fire the modeling flash by pressing the camera's depth-of-field preview button when an EL-5 is set as a receiver (📶). Modeling flash cannot be fired this way when an EL-5 is set as a sender.
- Auto power off takes effect in approx. 5 min. when the Speedlite is set as a sender.
- To turn on a receiver that is in auto power off mode, press the sender test flash button.
- Test flash firing is not available while a camera's flash timer or similar functions are active.
- You can change the time until auto power off takes effect on a receiver in [C.Fn-10](#).
- You can set up beeping when all Speedlites (senders and receivers) are fully charged in [P.Fn-05](#).

LCD Panel Illumination

In wireless flash photography, the sender LCD panel is on or off depending on whether senders and receivers (firing groups) are charged.

The sender LCD panel is lit when the sender and receiver are not fully charged. LCD panel illumination turns off approx. 12 sec. after senders and receivers are fully charged.



The sender LCD panel is lit again when sender and receiver charging resumes as you take pictures.

Caution

- < **CHARGE** > is displayed on the sender LCD panel as long as the sender or any receiver (firing groups) is not fully charged. Before shooting, confirm that < **CHARGE** > is not displayed on the LCD panel.

Flash Photography Applying Wireless Features

The wireless system eliminates the need to set up the following features on receivers, which are automatically configured based on sender settings. This enables wireless flash photography much like normal flash photography.

- [Flash Exposure Compensation](#) <  >
- [Flash Exposure Bracketing](#) <  >
- [FE Lock](#)
- [High-Speed Sync](#) <  >
- [Second-Curtain Sync](#) <  >
- [Manual Flash](#)
 - [Wireless Multiple-Flash Photography with Flash Ratio](#)
- [Stroboscopic Flash](#)



Note

- You can also set flash exposure compensation and flash coverage manually on each receiver.
- With an EL-5 set as sender, wireless second-curtain sync shooting is possible with other Canon Speedlites set as receivers. For details on compatible Speedlites, refer to the Supplemental Information ().

Using Multiple Senders

Multiple devices can be set as senders. Wireless flash photography under the same lighting arrangement (with the same receivers) is also possible using other cameras, by switching the camera that the sender is attached to.

< **SUB SENDER** > is displayed on the LCD panel when multiple senders are used.

Caution

- < **LINK** > lamps that are off or <  **SENDER** > display on LCD panels indicates that the Speedlites are not connected. After checking the transmission channel and wireless radio ID, restart each sender.
- Do not exceed a total of 16 senders and receivers in wireless flash photography.

Note

- Flash photography is possible even when the sender is a sub-sender.

Autoflash with Two Receiver Groups

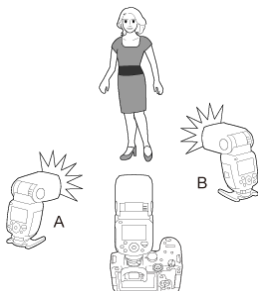

Receivers can be divided into firing groups A and B, and you can adjust the lighting balance (flash ratio) between them.

Exposure is automatically controlled, so that the groups' combined output provides standard exposure.

1. Push the joystick straight in.

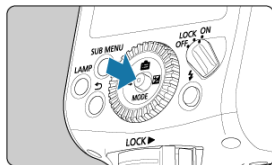

- Complete these settings on each receiver.

2. Set the receiver firing group in (1).

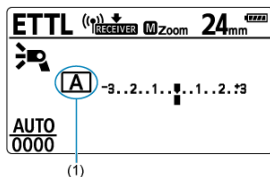

- Select either < A > or < B > for the firing group.
- Set one receiver to < A > and another to < B >.

3. Set the sender firing group in (2).

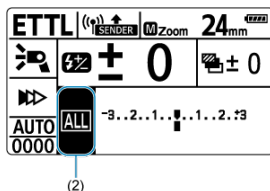

- Complete steps 3–5 on the sender.
- Press the joystick vertically or horizontally or turn < Ⓞ > to select the item, then push the joystick straight in.

4. Set to < A:B >.

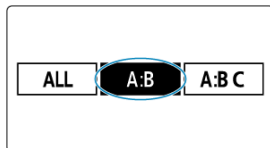

- Press the joystick horizontally or turn < Ⓞ > to select < A:B >, then push the joystick straight in.

5. Set the A:B flash ratio.

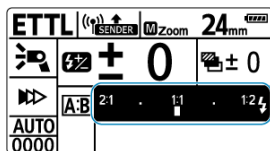

- Push the joystick straight in to select the item shown in the figure.
- Press the joystick horizontally or turn <  > to set the A:B flash ratio, then push the joystick straight in.

6. Check the connection and make sure the flash units are charged.

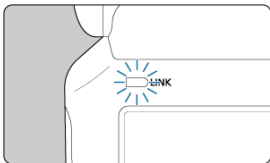

- Confirm that the < **LINK** > lamp is lit in green.

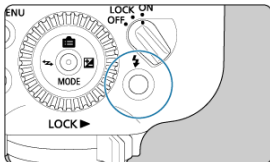

- Confirm that the sender and receiver flash-ready lamps are lit.
- The sender beeps after all Speedlites have been recharged when P.Fn-05 is set to [0] (🔌).

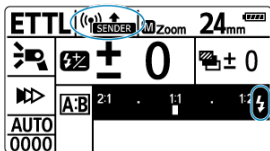

- Make sure < (🔌) **SENDER** > is not displayed on the sender LCD panel.
- Confirm that the < ⚡ > icon indicating completion of sender/receiver charging appears on the sender LCD panel (< **CHARGE** > is not displayed).
- For details on sender LCD panel illumination, see [LCD Panel Illumination](#).

7. Take the picture.

- The receivers fire at the flash ratio you have set.

Autoflash with Three Receiver Groups

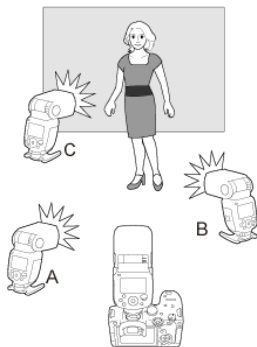

Once firing groups A and B have been set up, you can fire with multiple Speedlites by adding group C. For an overview of flash control, see [Group Control](#). Group C is useful when you want to eliminate shadows in the background behind subjects.

1. Push the joystick straight in.

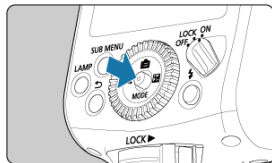

2. Select the item shown in (1).

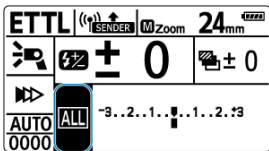

(1)

- Press the joystick vertically or horizontally or turn < Ⓞ > to select the item, then push the joystick straight in.

3. Set to < A:B C >.

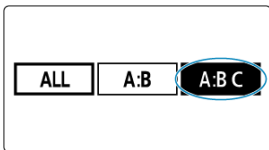

- Press the joystick horizontally or turn < Ⓞ > to select < A:B C >, then push the joystick straight in.

4. Add Speedlites to firing group A, B, or C and position them.

- Confirm that all receivers and the sender are set to the same transmission channel and wireless radio ID.
- Set up receivers for group A, B, or C and position them.

5. Check the channel and ID.

- Set the same transmission channel and wireless radio ID on senders and receivers, if they are different (Ⓞ).

6. Set the A:B flash ratio.

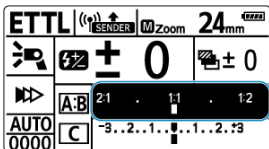

- Push the joystick straight in to select the item shown in the figure.
- Press the joystick horizontally or turn < Ⓞ > to set the A:B flash ratio, then push the joystick straight in.

7. Set the flash exposure compensation amount for firing group C.

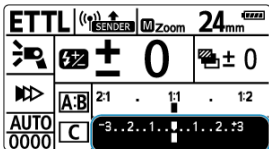

- Push the joystick straight in to select the item shown in the figure.
- Press the joystick horizontally or turn < Ⓞ > to set the amount of compensation, then push the joystick straight in.

8. Check the connection and make sure the flash units are charged.

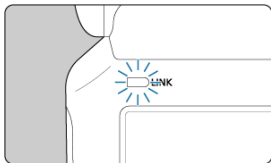

- Confirm that the < **LINK** > lamp is lit in green.

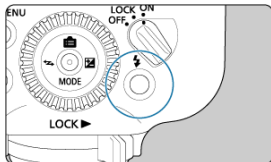

- Confirm that the sender and receiver flash-ready lamps are lit.
- The sender beeps after all Speedlites have been recharged when P.Fn-05 is set to [0] (☑).

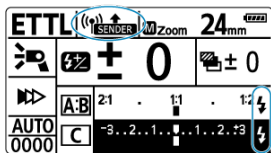

- Make sure < (☑) **SENDER** > is not displayed on the sender LCD panel.
- Confirm that the < ⚡ > icon indicating completion of sender/receiver charging appears on the sender LCD panel (< **CHARGE** > is not displayed).
- For details on sender LCD panel illumination, see [LCD Panel Illumination](#).

9. Check operation.

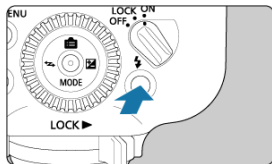

- Press the test flash button on the sender.
- The Speedlites fire. If they do not fire, confirm that they are within transmission range (📶).

10. Take the picture.

- Just as in normal flash photography, shoot after configuring the camera.

⚠ Caution

- Radio transmission is not possible when $\langle \text{SENDER} \rangle$ is displayed on the LCD panel. Double-check the transmission channels and wireless radio IDs of senders and receivers. If you cannot connect with the same settings, restart the senders and receivers.
- Aiming the units in firing group C directly at subjects may cause overexposure.

📄 Note

- You can fire the modeling flash by pressing the camera's depth-of-field preview button (📷).
- Auto power off takes effect in approx. 5 min. when the Speedlite is set as a sender.
- To turn on a receiver that is in auto power off mode, press the sender test flash button.
- Test flash firing is not available while a camera's flash timer or similar functions are active.

Wireless Multiple-Flash Photography with Flash Ratio

This section describes wireless multiple-flash shooting in manual flash mode. For each firing group, you can set flash output in a range from full 1/1 output to 1/1024 output, in 1/3-stop increments. All settings are configured on the sender.

1. Select **<MODE>** with the joystick.

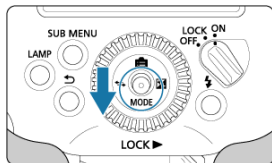

2. Set the flash mode to **<M>**.

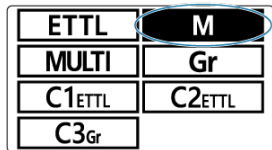

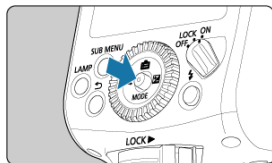

- Press the joystick vertically or horizontally or turn **<⊙>** to select **<M>**, then push the joystick straight in.

3. Push the joystick straight in.



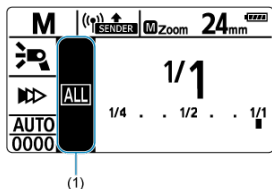



4. Select the item shown in (1).

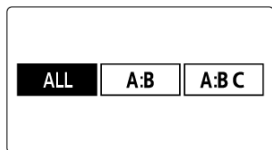

- Press the joystick vertically or horizontally or turn <  > to select the item, then push the joystick straight in.

5. Configure the firing group setting.



- Press the joystick horizontally or turn <  > to select a firing option from the following. This enables wireless multiple-flash photography with firing groups A–C added.
 - For the same output from all receivers, select <  >.
 - To set the output for firing groups A and B, select <  >.
 - To set the output for firing groups A, B, and C, select <  >.

6. Select a firing group.

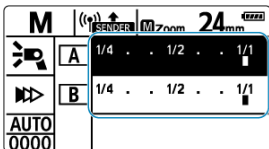

- If you selected < A:B > or < A:B:C > in step 5, push the joystick straight in, then press it vertically or horizontally or turn < Ⓞ > to select a group to set the flash output for.

7. Set the flash output.

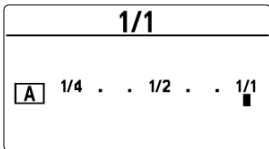

- Push the joystick straight in.
- Press the joystick horizontally or turn < Ⓞ > to set the flash output, then push the joystick straight in.
- Repeat steps 6–7 to set flash output for all groups.

8. Take the picture.

- Each group fires at the specified flash output.

⚠ Caution

- The setting range is 1/128–1/1 when high-speed sync is set.
- Speedlites other than the EL-5 used as receivers may not display low flash firing levels correctly.



Note

- When < > is set, set A, B, or C as the firing group for receivers. They will not fire when set to D or E.
- To fire multiple receivers at the same flash output, select < > in step 2.

Shooting in Group-Specific Flash Modes

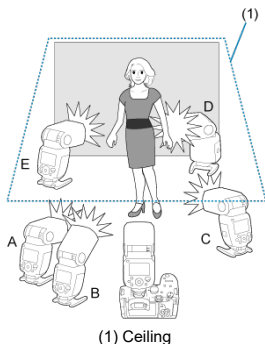

For up to five groups (A–E), you can shoot with each group set to a specific flash mode. Available flash modes include (1) E-TTL II / E-TTL autoflash, (2) manual flash, and (3) auto external flash metering. When the flash mode is (1) or (3), exposure is controlled to result in standard exposure for the main subject as a single group. This function is for advanced users who are very knowledgeable and experienced in lighting.

1. Use the joystick on the sender to select <MODE>.

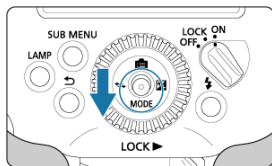

2. Set the flash mode to <Gr>.

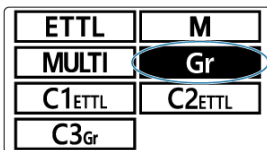

- Press the joystick vertically or horizontally or turn <⊙> to select <Gr>, then push the joystick straight in.
- The receiver flash mode is set automatically during shooting, as controlled by the sender.

3. Set the firing groups of the receivers.

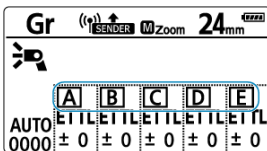

- Set a firing group (A–E) for each receiver.

4. Configure each firing group.

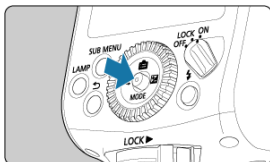

- On the sender, set the flash mode of each firing group.
- Push the joystick straight in.

Gr	(S) SENDER	M Zoom	24mm		
Flash icon	± 0	0	Flash icon ± 0		
▶▶	A	B	C	D	E
AUTO	ETTL	ETTL	ETTL	ETTL	ETTL
0000	± 0	± 0	± 0	± 0	± 0

- Press the joystick vertically or horizontally or turn <⊙> to select a firing group, then push the joystick straight in.

Setting the flash mode

Flash icon ± 0	Flash icon ± 0	
A	ETTL ± 0	-3..2..1..0..1..2..3
B	ETTL ± 0	-3..2..1..0..1..2..3
C	ETTL ± 0	-3..2..1..0..1..2..3
D	ETTL ± 0	-3..2..1..0..1..2..3
E	ETTL ± 0	-3..2..1..0..1..2..3

ETTL	M
Ext.A	OFF

- Press the joystick vertically or horizontally or turn <⊙> to select the flash mode from <ETTL>, <M>, or <Ext.A>.

Setting the flash output and flash exposure compensation amount

	± 0	± 0
A	ETTL ± 0	-3..2..1..0..1..2..3
B	M 1/1	1/4 . . 1/2 . . 1/1
C	ETTL ± 0	-3..2..1..0..1..2..3
D	ETTL ± 0	-3..2..1..0..1..2..3
E	ETTL ± 0	-3..2..1..0..1..2..3

	± 0	± 0
A	ETTL ± 0	-3..2..1..0..1..2..3
B	M 1/1	1/4 . . 1/2 . . 1/1
C	Ext.A ± 0	-3..2..1..0..1..2..3
D	ETTL ± 0	-3..2..1..0..1..2..3
E	ETTL ± 0	-3..2..1..0..1..2..3

- Press the joystick vertically or horizontally or turn < > to select the item, then push the joystick straight in.
- Press the joystick horizontally or turn < > to set the flash output or flash exposure compensation amount, then push the joystick straight in.
- For < **M** >, set the flash output. For < **ETTL** > or < **Ext.A** >, set the flash exposure compensation amount as needed.
- Repeat step 4 to configure flash features for all firing groups.
- By setting P.Fn-03 to [1] (), you can change this setting simply by turning < >. To select a setting item when P.Fn-03 is set to [1], press the joystick vertically or horizontally.

5. Before shooting, confirm that flash recharging is finished.

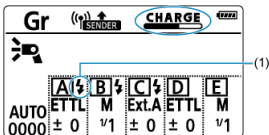

- When < **CHARGE** > is displayed, you can determine which firing groups are not fully charged from the icons. For example, the icon shown in (1) indicates that firing group < **A** > is fully charged.
- < **CHARGE** > is no longer displayed after all groups are fully charged.
- For other details on checking recharge status, see step 7 in [Autoflash with One Receiver](#).
- Each receiver fires at the same time in the flash mode you have set.

Caution

- For < **Ext.A** > flash mode, make sure the receivers support auto external flash metering. Receivers will not fire unless it is supported.
- In < **ETTL** > or < **Ext.A** > flash mode, exposure is controlled to obtain standard exposure for the main subject as if using a single group, which may cause overexposure if multiple firing groups are pointing toward the main subject.

Note

- For details on < **Ext.A** >, refer to the instruction manual of Speedlites that support auto external flash metering.
- Letters of groups that fire do not need to be in consecutive alphabetical order; for example, A, C, E can be set.
- Set any group you do not wish to fire to < **OFF** > when configuring flash modes in step 4. Similarly, modeling lamps of groups set to < **OFF** > are not lit when the sender < **LAMP** > button is pressed.

Firing Test Flash/Modeling Flash from Receivers

Test flash or modeling flash (☑) can be fired in radio transmission wireless flash photography from EL-5 Speedlites set as receivers.

1. Push the joystick straight in.

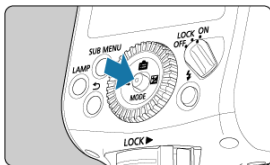

2. Fire the flash.

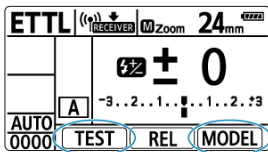

[Test flash firing]

- Press the joystick vertically or horizontally or turn <⊙> to select < **TEST** >, then push the joystick straight in.

[Modeling flash] (☑)

Available when cameras other than models in the EOS R or EOS M series are used as a sender with the EL-5 as a receiver.

- Press the joystick vertically or horizontally or turn <⊙> to select < **MODEL** >, then push the joystick straight in.
- The wireless system fires test or modeling flash after the receiver transmits a firing signal to the sender.

 **Caution**

- For precautions on modeling flash, see [Modeling Flash](#).

 **Note**

- When there are multiple senders () , the firing signal is transmitted to the main sender.

Remote Release from Receivers

EL-5 Speedlites set as receivers can be used to shoot remotely in radio transmission wireless flash photography, enabling remote control shooting.

1. Push the joystick straight in.

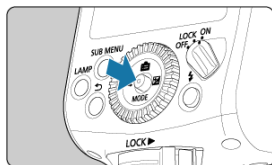

2. Take the picture.

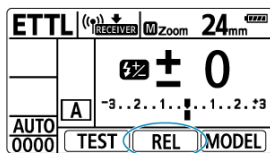

- Press the joystick vertically or horizontally or turn <  > to select < **REL** >, then push the joystick straight in.
- The sender shoots after the receiver transmits a firing signal to it.

Caution

- Shooting is not possible unless the camera can focus on subjects with AF. Consider setting the lens focus mode switch to < **MF** > and focusing manually before remote release.



Note

- The camera shoots in single shooting mode regardless of the current drive mode setting.
- When there are multiple senders (🔗), the firing signal is transmitted to the main sender.
- < **RELEASE** > is displayed on the sender LCD panel during remote release from receivers.

Linked Shooting

Linked shooting is supported, which automatically releases the shutters of receiver cameras when the sender fires. You can perform linked shooting with up to 16 sender and receiver cameras in all. This is useful when shooting a subject from multiple angles at the same time. For linked shooting, attach Speedlites or Speedlite Transmitters that support radio transmission wireless flash photography to the cameras.

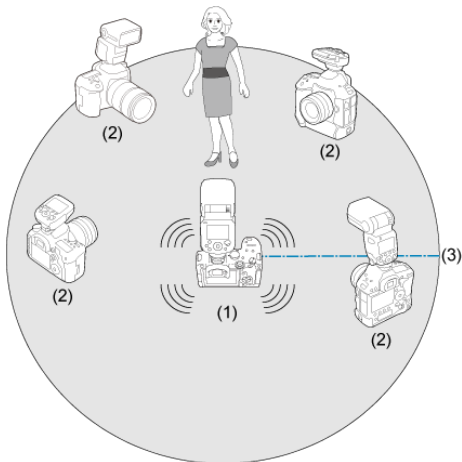

- (1) Sender camera
- (2) Receiver cameras
- (3) Transmission range: Approx. 30 m / 98.4 ft.

Note

- For convenience in this guide, the EL-5 and the other cameras set up for linked shooting are referred to as the “sender camera” and “receiver cameras,” respectively.

Caution

- Shooting is not simultaneous, because receiver cameras shoot slightly after the sender camera.

Before following these steps, attach a Speedlite or transmitter to all cameras you will use in linked shooting. For instructions on setting up other devices, refer to the instruction manuals of the devices.

1. Select <  > with the joystick.

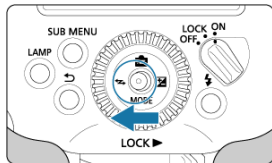

2. Set to < **LINKED SHOT** >.

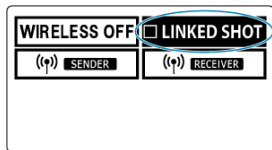

- Press the joystick vertically or horizontally or turn <  > to select < **LINKED SHOT** >, then push the joystick straight in.

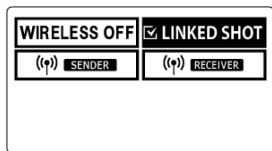

- Display then changes to < **LINKED SHOT** >.

3. Set as a sender or receiver.

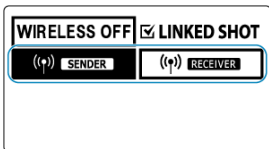

- Press the joystick vertically or horizontally or turn < Ⓞ > to select < Ⓞ > **SENDER** > or < Ⓞ > **RECEIVER** >, then push the joystick straight in.

4. Push the joystick straight in.

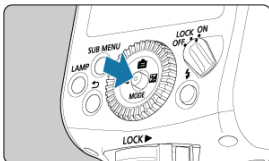

5. Select the item shown in (1).

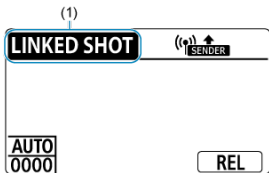

- Press the joystick vertically or horizontally or turn < Ⓞ > to select the item, then push the joystick straight in.

6. Set the flash mode.

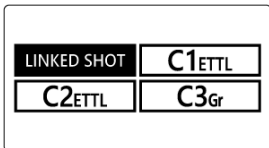

- Press the joystick vertically or horizontally or turn < Ⓞ > to select the flash mode, then push the joystick straight in.
- Descriptions next to < C1 >–< C3 > vary depending on the registered settings.
- For details on Custom flash modes, see [Custom Flash Modes](#).

7. Set the transmission channel and wireless radio ID.

- For instructions, see [Setting the Transmission Channel / Wireless Radio ID](#).

8. Set up shooting on the camera.

9. Set up all Speedlites.

- In the linked shooting setting, set up all Speedlites you will use in linked shooting as senders or receivers.
- Do the same for any transmitters you will use.
- Changing a Speedlite from receiver to sender in step 3 automatically changes other Speedlites (or transmitters) that were set as senders to receivers.

10. Position the receiver cameras.

- Position all receiver cameras within approx. 30 m / 98.4 ft. of the sender camera.
- Confirm that the < LINK > lamp of receivers is lit in green.

11. Take the picture.

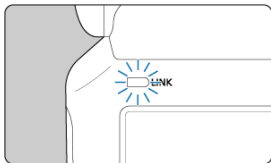

- Before shooting, confirm that the sender's **< LINK >** lamp is lit in green.
- Shooting with the sender camera automatically activates shooting by receiver cameras.
- **< RELEASE >** appears on the LCD panel of receivers that were used in linked shooting.

Note

- To cancel linked shooting, change the setting in step 2 to **< □ LINKED SHOT >** on each Speedlite.
- This feature can be used for remote control of linked shooting even without attaching the sender Speedlite to a camera. To fire from all receiver cameras, push the sender joystick straight in, then press it vertically or horizontally or turn **< Ⓢ >** to select **< REL >**.
- Auto power off takes effect in approx. 5 min. in linked shooting, for both senders and receivers. If more time than this will pass between shots in linked shooting, set auto power off to [OFF] on both senders and receivers ([C.Fn-01-1](#)).
- Each Speedlite (senders and receivers) set to [0] in P.Fn-05 (**Ⓢ**) beeps after it is fully charged.

 Caution

- Consider setting the lens focus mode switch to <MF> on receiver cameras and focusing manually before linked shooting. Receiver cameras cannot shoot in linked shooting unless they can focus on subjects with AF.
- Flash can be fired in linked shooting when P.Fn-02 is set to [1] , but if multiple Speedlites fire together, it may prevent suitable exposure or cause uneven exposure.
- Transmission range may be shorter depending on factors such as Speedlite positioning, the surrounding environment, and weather conditions.
- This linked shooting is equivalent to linked shooting with the WFT series of wireless file transmitters. However, WFT series transmitters cannot be used in this linked shooting. Also note that the shutter-release time lag differs from that of the WFT series.

Customizing the Speedlite

This chapter describes how to customize the Speedlite with Custom/Personal Functions (C.Fn/P.Fn).

Caution

- Operations described in this chapter are not available when the Speedlite is attached to a camera in Full Auto or Basic Zone modes. Set the camera's shooting mode to < **Fv** >, < **P** >, < **Tv** >, < **Av** >, < **M** >, or < **Bulb (B)** > (Creative Zone).

- [Setting Custom and Personal Functions](#)
- [Customization with Custom Functions](#)
- [Customization with Personal Functions](#)
- [Custom Flash Modes](#)

Setting Custom and Personal Functions

[C.Fn: Custom Functions](#)

[P.Fn: Personal Functions](#)

[Custom Function List](#)

[Personal Function List](#)

[Clearing All Custom/Personal Functions](#)

You can customize Speedlite functions to suit your shooting preferences. The functions for this purpose are called Custom Functions and Personal Functions. Personal Functions also enable customization specifically for the EL-5.

1. Press the <SUB MENU> button.

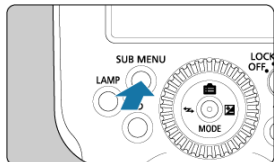

2. Display the Custom Functions screen.

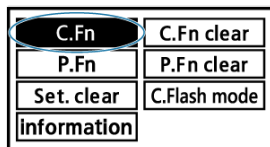

- Press the joystick vertically or horizontally or turn < Ⓞ > to select < **C.Fn** >, then push the joystick straight in.

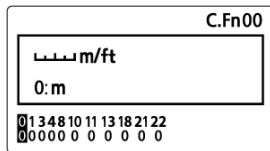

- The Custom Functions screen is displayed.

3. Select an item to set.

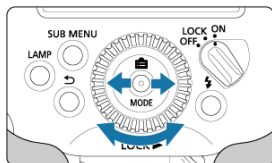

- Press the joystick horizontally or turn < Ⓞ > to select the item (number) to set.

4. Change the setting.

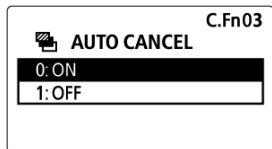

- Push the joystick straight in.
- Press the joystick vertically or turn < Ⓞ > to select an option, then push the joystick straight in.

1. Press the <SUB MENU> button.

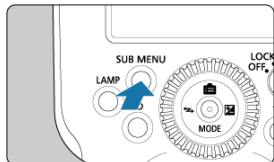

2. Display the Personal Functions screen.

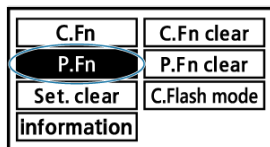





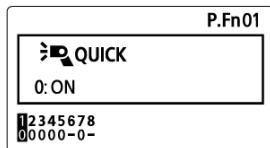





- Select < **P.Fn** > as in step 2 for Custom Functions, then push the joystick straight in.

3. Set the function.









- Set Personal Functions as in steps 3–4 for Custom Functions.

Custom Function List

Number	Item
C.Fn-00	<  m/ft > Distance indicator display
C.Fn-01	<  > Auto power off
C.Fn-03	<  AUTO CANCEL > FEB auto cancel
C.Fn-04	<  > FEB sequence
C.Fn-08	<  AF > AF-assist beam firing
C.Fn-10	<  > Receiver auto power off timer
C.Fn-11	<  > Receiver auto power off cancel
C.Fn-13	<  > Flash exposure compensation setting
C.Fn-18	< MODELING LAMP > Modeling lamp activation
C.Fn-21	<  > Light distribution
C.Fn-22	<  > LCD panel illumination

Personal Function List

Number	Item	
P.Fn-01	<  QUICK >	Quick flash
P.Fn-02	<  LINKED SHOT >	Flash firing during linked shooting
P.Fn-03	<  DIRECT >	Change settings with dial
P.Fn-04	< FEM >	FE memory
P.Fn-05	<  >	Beeping
P.Fn-06	< MODELING LAMP  >	Modeling lamp (brightness)
P.Fn-07	< MODELING LAMP  >	Modeling lamp period of illumination
P.Fn-08	<  CUSTOMIZE DIRECT >	Joystick customization

Clearing All Custom/Personal Functions

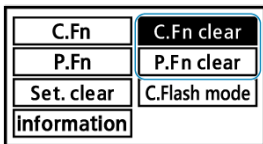

Select < **C.Fn clear** > or < **P.Fn clear** > on the screen shown above, then select < **OK** > to clear all custom functions or personal functions.

Caution

- Clearing all Custom Functions will not clear C.Fn-00.

Note

- You can also set or clear Speedlite Custom Functions from the camera menu (ⓘ).
- All Custom/Personal Functions registered in < **C1** >, < **C2** >, and < **C3** > Custom flash mode are cleared.

Customization with Custom Functions

C.Fn-00: m/ft (Distance indicator display)

You can select meters or feet for the distance indicator display on the LCD panel.

- **0: m (Meters (m))**
- **1: ft (Feet (ft))**

Note



- The right end of the effective flash range on the LCD panel changes to < ▶ > when the effective flash distance exceeds 18 m / 60 ft.

C.Fn-01: (Auto power off)

To conserve power, the Speedlite turns off automatically if left idle for approx. 90 sec., but this function can be disabled.

- **0: ON**
- **1: OFF**

Note

- Auto power off takes effect in approx. 5 min. when the Speedlite is set as a sender in radio transmission wireless flash photography () or configured for linked shooting () .
- When attached to a camera, the Speedlite turns off automatically if left idle for approx. 90 sec. after the camera has entered auto power off mode.
- Setting [**Auto power off**] on the camera to [**Disable**] also disables it on the Speedlite.

C.Fn-03: AUTO CANCEL (FEB auto cancel)

You can set whether to cancel FEB automatically after the three shots are taken for FEB.

- **0: ON (Enabled)**
- **1: OFF (Disabled)**

C.Fn-04: (FEB sequence)

You can change the FEB shooting sequence. 0: Standard exposure, -: Negative compensation (darker), and +: Positive compensation (brighter).

- **0: 0** → - → +
- **1: -** → 0 → +

C.Fn-08: AF (AF-assist beam firing)

- **0: ON (Enabled)**
- **1: OFF (Disabled)**
Disables the Speedlite's AF-assist beam.

C.Fn-10: (Receiver auto power off timer)

You can change the time until auto power off takes effect when the Speedlite is set as a receiver in radio transmission wireless flash photography.  is displayed on the LCD panel when the receiver enters auto power off mode. Set this function for each receiver.

- **0: 60 min.**
- **1: 10 min.**





C.Fn-11: (Receiver auto power off cancel)

Receivers that have entered auto power off mode in wireless flash photography can be turned on by pressing the sender test flash button.

You can change the time allowed for receivers in auto power off mode to accept this signal. Set this function for each receiver.

- **0: 8 h (within 8 hr.)**
- **1: 1 h (within 1 hr.)**

C.Fn-13: (Flash exposure compensation setting)

- **0:**  +  (button + dial)
- **1:**  (Direct setting with dial)
You can turn <  > to set the amount of flash exposure compensation or the flash output directly, without first selecting <  > with the joystick.

C.Fn-18: MODELING LAMP (Modeling lamp activation)

You can select how the modeling lamp is activated.





- **0:** < LAMP > (button)
- **1:** <  x2 > (half-press shutter button twice)

Note

- The < LAMP > button can still be used even with this setting set to [1].
- Note that [Macro:Focusing lamp on/off] in camera menus refers to configuring modeling lamp activation.

C.Fn-21: / / (Light distribution)

You can change the Speedlite's light distribution (flash coverage) characteristics relative to the shooting angle of view when flash coverage is set to <  > (Auto).

- **0:**  (Standard)
Optimal flash coverage for the shooting angle of view is set automatically.
- **1:**  (Guide number priority)
Effective when prioritizing flash output, although image edges are slightly darker than when set to [0]. Flash coverage is automatically set slightly more toward the telephoto end than the actual shooting angle of view. The display changes to <  >.
- **2:**  (Light distribution priority)
Effective when minimizing vignetting, although the flash range is slightly shorter than when set to [0]. Flash coverage is automatically set slightly more toward the wide-angle end than the actual shooting angle of view. The display changes to <  >.

C.Fn-22: (LCD panel illumination)

The LCD panel is illuminated in response to button or dial operations. You can change this illumination setting.

- **0: 12 sec. (illuminated for 12 sec.)**
- **1: OFF (Disable panel illumination)**
- **2: ON (stays on)**

Customization with Personal Functions

P.Fn-01: QUICK (Quick flash)

You can set whether to fire the flash (Quick flash) when the flash-ready lamp is still blinking in red (before fully charged), so there is less time to wait for recharging.

- **0: ON (Enabled)**
- **1: OFF (Disabled)**

Caution

- Using Quick flash in continuous shooting () may cause underexposure, due to the reduced flash output.

P.Fn-02: LINKED SHOT (Flash firing during linked shooting)

You can set whether to fire the Speedlite attached to the camera in linked shooting (). Set for each Speedlite used in linked shooting.

- **0: OFF (Disabled)**
The Speedlite does not fire during linked shooting.
- **1: ON (Enabled)**
The Speedlite fires during linked shooting.

Caution

- Firing multiple Speedlites together in linked shooting may prevent suitable exposure or cause uneven exposure.

P.Fn-03: DIRECT (Change settings with dial)

You can select whether to allow direct configuration of the kinds of functions shown in the lower figure simply by turning <  > on screens such as this one that are accessed by pushing the joystick straight in.

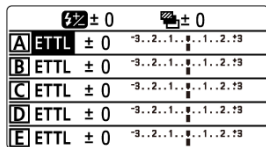
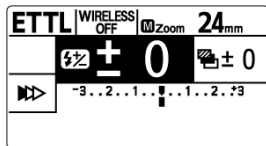

- **0: OFF (Disabled)**

Normal method of operation.

- **1: ON (Enabled)**

Enables selection of setting items (for the flash exposure compensation amount, manual flash output, firing group control, flash ratio, flash modes in group firing, receiver firing groups, and FEB) with the joystick and direct configuration simply by turning <  >.

In < **MULTI** > flash mode, flash frequency and flash count can be set directly.

Caution

- To select a setting item on the setting screen when P.Fn-03 is set to [1], press the joystick vertically or horizontally.

P.Fn-04: FEM (FE memory)

You can select whether to update, based on E TTL flash output, the flash output maintained in manual mode.

- **0: OFF**
- **1: ON**
- **2: ON / **MODE**E TTL ↔ M**

Note

- Setting P.Fn-04 to [2] limits the modes available to **< E TTL >** and **< M >** when you press the joystick down and select **< MODE >**. To select another mode, push the joystick straight in to display the setting screen, press it vertically or horizontally or turn **< Ⓢ >** to select an item, then select the mode.

P.Fn-05: (Beeping)

You can enable beeping after the Speedlite is fully charged.

- **0: ON**
In normal shooting (on-camera flash photography), the Speedlite beeps after it is fully charged.
With the Speedlite set as a sender in radio transmission wireless flash photography, the sender beeps after all Speedlites (senders and receivers) are fully charged. Sender beeping enables you to confirm recharging of the entire wireless system. On receivers, P.Fn-05 can be set to [0] or [1]. With Speedlites set as wireless receivers in linked shooting () , each Speedlite set to [0] beeps after it is fully charged.
- **1: OFF**
The Speedlite does not beep.

Caution

- Also when set to [0], the Speedlite beeps if high flash head or battery temperature has restricted firing () .

P.Fn-06: MODELING LAMP ☀️ (Modeling lamp (brightness))

You can set the brightness of the modeling lamp.

Turn < Ⓞ > to select an option, then push the joystick straight in.

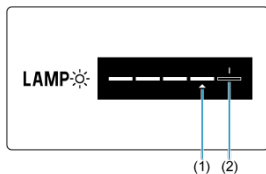

- (1) Selected cursor position
- (2) Default indicator

- **LAMP ☀️**: Press the joystick horizontally or turn < Ⓞ > to set modeling lamp brightness.

Note

- Also when the modeling lamp is lit, you can adjust brightness by pressing the joystick horizontally or turning < Ⓞ >, then pressing the joystick straight in.

P.Fn-07: MODELING LAMP ☾ (Modeling lamp (period of illumination))

You can set the period of illumination of the modeling lamp.

- **0: 5 min.**
- **1: 30 min.**
- **2: Unlimited**

P.Fn-08: CUSTOMIZE DIRECT (Joystick customization)

You can assign frequently used functions to vertical or horizontal joystick positions. This simplifies access to the setting screen – just press the joystick in the direction that the function is assigned to.

To select a direction for the setting, press the joystick horizontally, and to select the function to assign, press it vertically.

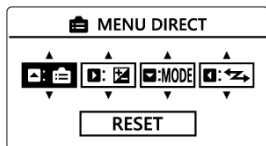

- The following functions can be configured.
 - < >: Menu direct
 - < **MODE** >: Flash mode
 - < >: Wireless/linked shooting setting
 - < >: Flash exposure compensation/flash output setting
 - < **ZOOM** >: Flash zoom
 - < **SYNC** >: Shutter synchronization
 - < >: Modeling lamp intensity

Note

- To restore defaults for all customized settings, press the joystick horizontally, select [**RESET**], then push the joystick straight in.

Custom Flash Modes

- [Registering Custom Flash Modes](#)
- [Canceling Automatic Updating](#)
- [Clearing Registered Custom Flash Modes](#)
- [Linking with Camera Shooting Modes](#)

The Speedlite can be used with settings for flash modes and wireless functions that you register in advance.

Note

- Initially, Custom flash modes are as follows.
 - C1: E TTL
 - C2: E TTL
 - C3: Group firing, set as sender

1. Select **<MODE>** with the joystick.

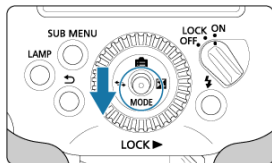

2. Set the flash mode.

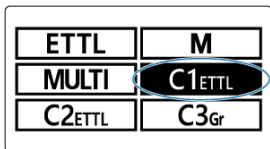

- Press the joystick vertically or horizontally or turn <⊙> to select <C1>, <C2>, or <C3>, then push the joystick straight in.
- Descriptions next to <C1>–<C3> vary depending on the registered settings.

Registering Custom Flash Modes

You can register current Speedlite settings such as general flash functions, Custom functions (except C.Fn-00) (🔒), and Personal functions (🔒) as Custom flash modes assigned to < C1 >-< C3 > modes.

1. Press the < SUB MENU > button.

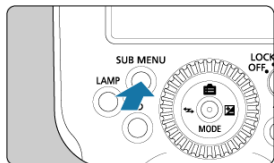

2. Select < C.Flash mode >.

C.Fn	C.Fn clear
P.Fn	P.Fn clear
Set. clear	C.Flash mode
information	

- Press the joystick vertically or horizontally or turn < Ⓞ > to select < C.Flash mode >, then push the joystick straight in.

3. Choose a Custom flash mode to register the settings to.

C.Flash mode	
C1 Register	C1 Clear
C2 Register	C2 Clear
C3 Register	C3 Clear
C.Flash mode settings	

- Press the joystick vertically or horizontally or turn < Ⓞ > to select < C1 register >, < C2 register >, or < C3 register >, then push the joystick straight in.

4. Register the desired items.

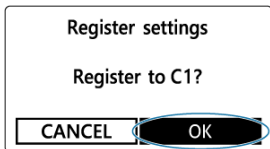

- Press the joystick horizontally or turn < Ⓞ > to select < **OK** >, then push the joystick straight in.

Canceling Automatic Updating

If you change a setting while shooting in Custom flash mode, the mode can be automatically updated with the new setting. By default, this feature is enabled (< >).

1. Press the < SUB MENU > button.

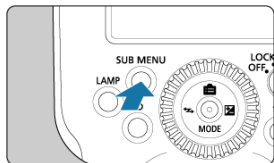

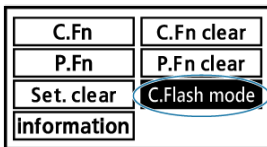

2. Select < C.Flash mode >.

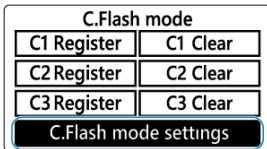

- Press the joystick vertically or horizontally or turn <  > to select < C.Flash mode >, then push the joystick straight in.

3. Select < C.Flash mode settings >.



- Press the joystick vertically or horizontally or turn <  > to select < C.Flash mode settings >, then push the joystick straight in.

4. Select < Auto update set >.

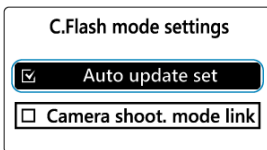

- Press the joystick vertically or turn <  > to select < Auto update set >, then push the joystick straight in.

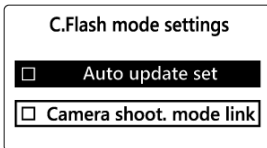

- Display then changes to < Auto update set >.

Clearing Registered Custom Flash Modes

On the screen of step 3 in [Registering Custom Flash Modes](#), select the Custom flash mode to clear (< **C1 clear** >, < **C2 clear** >, or < **C3 clear** >). General flash functions, Custom functions (except C.Fn-00) (☒), and Personal functions (☒) are cleared.

Linking with Camera Shooting Modes

Custom flash modes can be used in conjunction with Custom shooting modes on a camera. For camera instructions, refer to the camera instruction manual.

Available flash modes vary depending on the camera shooting mode. [E-TTL II flash metering], [Manual flash], and [MULTI flash (stroboscopic)] are available in <Fv>, <P>, <Tv>, <Av>, <M>, and <Bulb (B)> (Creative Zone) modes. When the camera is in a Custom shooting mode (<C1>--<C3>), the Speedlite switches to the corresponding Custom flash mode.

1. Press the <SUB MENU> button.

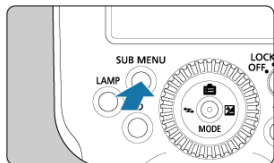



2. Select <C.Flash mode>.

C.Fn	C.Fn clear
P.Fn	P.Fn clear
Set. clear	C.Flash mode
Information	

- Press the joystick vertically or horizontally or turn <⊙> to select <C.Flash mode>, then push the joystick straight in.

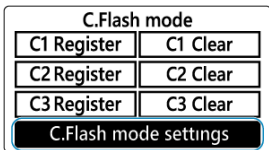
3. Select < **C.Flash mode settings** >.



- Press the joystick vertically or horizontally or turn <  > to select < **C.Flash mode settings** >, then push the joystick straight in.

4. Select < Camera shoot. mode link >.

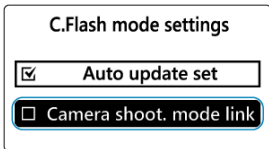

- Press the joystick vertically or turn <  > to select < Camera shoot. mode link >, then push the joystick straight in.

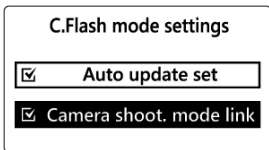

- Display then changes to < Camera shoot. mode link >.

 **Caution**

- When the role of receiver is registered in a Custom flash mode, that mode cannot be linked to camera shooting modes.



Note

- Custom flash modes are only linked to camera modes when the Speedlite is used with cameras that have Custom shooting modes.
- Custom shooting and flash modes with the same number are linked. When used with cameras without Custom shooting mode < **C3** >, the Speedlite's Custom flash mode < **C3** > is not available.
- When Speedlite flash modes are linked to camera shooting modes, flash mode icons (< **C1** >, < **C2** >, and < **C3** >) are displayed with a dotted line and cannot be selected.

Reference

This chapter describes the flash system and includes frequently asked questions.

- [Flash Firing Restriction Due to Temperature Increase](#)
- [Troubleshooting Guide](#)
- [Specifications](#)
- [Accessories](#)

Flash Firing Restriction Due to Temperature Increase

 [Temperature Increase Warning](#)

 [Continuous Flash Count and Rest Time](#)



Repeated use of continuous, stroboscopic, or modeling flash at short intervals may increase the temperature of the flash head, battery, and areas near the battery compartment.

Repeated flash firing gradually increases the firing interval, up to approx. 4 sec., to avoid wearing out or damaging the flash head from overheating. Continuing to fire in this state will automatically restrict flash firing.

Note that when flash firing is restricted, a high-temperature warning icon is displayed, and the flash photography firing interval is automatically set to approx. 8 or 20 sec. (levels 1 and 2, respectively).

Temperature Increase Warning

At each of the two levels, a different warning icon is displayed as the internal temperature rises. Continuing to fire after level 1 is reached changes the state to level 2.





Display / Beeping	Level 1 (Firing Interval: Approx. 8 sec.)	Level 2 (Firing Interval: Approx. 20 sec.)
Icon		
LCD panel illumination	Lit	Blinking
Beeping	With P.Fn-05 set to [0]: Warning beep	

Modeling lamp temperature increase warning

The following warning appears when the modeling lamp becomes hot.
To clear warning, push the joystick straight in, or press the <  > button.



The modeling lamp may dim or turn off if the ambient temperature around it becomes too high.

Display	Level 1		Level 2	
Icon				
	When on	When off	When on	When off
Brightness	When set to max. brightness: dimmed		Off	

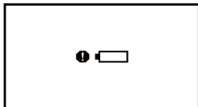

Battery temperature increase warning

The following icon appears when the battery becomes hot. After this, display reverts to the same state as the temperature increase warning ().



Continuous Flash Count and Rest Time

The following table shows the estimated continuous flash count until level 1 warning display, along with the estimated rest time required until normal flash photography can be resumed.

Function	Estimated Continuous Flash Count Until Level 1 Warning		Estimated Rest Time Required
	Flash Coverage		
	14 mm*1, 24 mm–28 mm	35–200 mm	
Continuous, at full output ()	40 times or more	85 times or more	At least 40 min.
Modeling flash ()			
Stroboscopic flash ()	Varies depending on firing conditions		

* As measured in manual flash mode according to Canon testing standards.

* Using a new, fully charged Battery Pack LP-EL



* 1: When using the wide panel

Caution

- **Do not touch the flash head, battery, or near the battery compartment after continuous flash firing.**

After repeated use of continuous flash or modeling flash at short intervals, do not touch the flash head, battery, or near the battery compartment. The flash head, battery, and area near the battery compartment may become hot, which poses a risk of burns.

 Caution

- Do not open or close the battery compartment cover while flash firing is restricted. This will cancel the flash firing restriction, which is potentially very dangerous.
- The firing interval becomes longer as the flash head becomes hotter, even if no level 1 warning is displayed.
- After a level 1 warning appears, stop using the Speedlite for at least 40 min.
- Even if you stop firing after a level 1 warning appears, a level 2 warning may still be displayed.
- Flash photography in < **ETTL** > flash mode or in high temperatures may restrict the flash count sooner than indicated in the table.
- For flash count precautions, see [Precautions on continuous flash firing](#), [Stroboscopic Flash](#), and [Modeling Flash](#).
- In rare cases, environmental factors such as high temperatures may prevent firing.
- The Speedlite does not issue a warning beep when P.Fn-05 is set to [1] () , even when firing is restricted.
- No warning is given by LCD panel illumination when C.Fn-22 is set to [1] () , even if the flash head becomes hot.

Troubleshooting Guide

- [✔ Power-related problems](#)
- [✔ Normal flash photography](#)
- [✔ Radio transmission wireless flash photography](#)
- [✔ Linked shooting](#)

Troubleshoot Speedlite issues as described in this section. If the problem persists, contact a Canon Service Center.

Power-related problems

Batteries cannot be charged with the charger.

- Batteries are not charged unless the remaining capacity is lower than approx. 90%.
- Do not use battery packs other than a genuine Canon Battery Pack LP-EL.

The charger lamp blinks rapidly.

- Constant, rapid orange blinking of the lamp indicates that a protection circuit has prevented charging because (1) there is a problem with the battery charger or battery, or (2) communication with a non-Canon battery has failed. In the case of (1), unplug the charger, reinsert the battery pack, and wait 2–3 minutes before plugging the charger in again. If the problem persists, contact a Canon Service Center.

The charger lamp does not blink.

- For safety, hot batteries inserted in the charger are not charged, and the lamp remains off. Charging also stops automatically if the battery becomes hot for any reason, in which case the lamp blinks continuously. Charging resumes automatically after the battery has cooled off.

[Cannot communicate with battery Use this battery?] appears.



- The battery pack may be damaged. If so, purchase a replacement.
- For safety, consider using a genuine Canon Battery Pack LP-EL.
- As a safety mechanism, flash recharging will take longer if you continue using an unresponsive battery pack.
- Reinsert the battery (🔍).
- If the electrical contacts are dirty, use a soft cloth to clean them.

The battery becomes exhausted quickly.

- Use a fully charged battery (🔍).
- The battery performance may have declined. See [Checking Battery Information](#) and check for battery performance issues. If battery performance is poor, purchase a replacement.
- Doing any of the following exhausts the battery faster.
 - Keeping the modeling lamp on for extended periods
 - Using wireless functions
 - Firing modeling flash repeatedly

The power turns off by itself.

- Auto power off has been activated. To prevent the power from turning off automatically, set C.Fn-01 to [1] on the Custom Functions screen (🔍).

Normal flash photography

The power does not turn on.

- Make sure the battery compartment cover is closed (🔧).
- Replace the battery with a new one.

The Speedlite does not fire.

- Insert the mounting foot all the way into the camera hot shoe and slide the lock lever right to secure the Speedlite to the camera (🔧).
- If **< CHARGE >** remains displayed even after approx. 15 sec., replace the battery (🔧).
- Blow off any foreign material on the contacts between the Speedlite and camera with a commercially available blower or similar tool.
- If the contacts between the Speedlite and camera (🔧) get wet, turn off the Speedlite and allow it to dry.
- The firing interval becomes longer (🔧) after continuous firing over a short period, which will cause the flash head temperature to rise and restrict flash firing.
- For safety, batteries that are hot are not charged. Charging also stops automatically if the battery becomes hot for any reason. Charging resumes automatically after the battery has cooled off (🔧).

The power turns off by itself.

- The Speedlite's auto power off has been activated (🔧). Press the shutter button halfway, or press the test flash button (🔧).

Pictures are under or overexposed.

- If the main subject looks very dark or very bright, set flash exposure compensation (🔧).
- If there are highly reflective objects in the picture, use FE lock (🔧).
- With high-speed sync, the faster the shutter speed, the lower the guide number. Move closer to the subject (🔧).

The bottom of the picture looks dark.

- Shoot at least 0.5 m / 1.6 ft. away from the subject.
- When shooting within 1 m / 3.3 ft. of the subject, set the bounce angle down by 7° (🔧).
- Remove any attached lens hoods.

The picture periphery looks dark.

- Set the flash coverage to **< A >** (Auto) (🔧).
- When manually setting the flash coverage, set a flash coverage wider than the shooting angle of view (🔧).
- Make sure C.Fn-21 is not set to [1] (🔧).

Pictures are very blurry.

- Shooting in < **Av** > aperture-priority AE mode under low light automatically activates slow-sync shooting, which results in slower shutter speeds. Use a tripod, or set the shooting mode to < **P** > program AE or fully automatic mode (🔗). Note that you can also set the flash sync speed in the camera setting [**Flash sync. speed in Av mode**] (🔗).

Flash coverage is not set automatically.

- Set the flash coverage to < **A** > (Auto) (🔗).
- Insert the mounting foot all the way into the camera hot shoe and slide the lock lever right to secure the Speedlite to the camera (🔗).

Flash coverage cannot be set manually.

- Retract the wide panel (🔗).

Functions cannot be set.

- Set the camera's shooting mode to < **Fv** >, < **P** >, < **Tv** >, < **Av** >, < **M** >, or < **Bulb (B)** > (Creative Zone).
- Set the Speedlite's power switch to < **ON** > instead of < **LOCK** > (🔗).

The modeling lamp does not light up.

- Stop using the Speedlite for 40 min. if the modeling lamp goes off. If the problem persists, contact a Canon Service Center.

Flash output from the AF-assist beam cannot be adjusted.

- Flash output is fixed for the EOS R3, EOS R7, and EOS R10. For other cameras with a multi-function shoe, flash output is automatically adjusted to suit brightness.

Receivers do not fire or unexpectedly fire at full output.

- Set the sender to <(ⓘ) **SENDER**> and receivers to <(ⓘ) **RECEIVER**> (🔗).
- Use the same settings for transmission channels and wireless radio IDs on the sender and receivers (🔗).
- Make sure receivers are within transmission range of the sender (🔗).
- Run a transmission channel scan and set the channel with the strongest signal (🔗).
- To the extent possible, position receivers within a direct line of sight of the sender.
- Make sure receivers are facing the sender.
- The camera's built-in flash cannot be used as a sender in radio transmission wireless flash photography.

Pictures are overexposed.

- When using autoflash with three firing groups (A–C), do not fire with firing group C pointing toward the main subject (🔗).
- When shooting with each firing group set to its own flash mode, do not fire multiple firing groups in <**ETTL**> mode that are all pointing toward the main subject (🔗).

<(ⓘ)Tv> is displayed.

- Set the shutter speed one step slower than the maximum flash sync shutter speed (🔗).

LCD panel illumination turns on and off.

- The sender LCD panel turns on or off based on receiver (firing group) recharge status. See [LCD Panel Illumination](#).

Standard exposure is not provided, or exposure is uneven.

- Firing multiple Speedlites together in linked shooting may prevent suitable exposure or cause uneven exposure. Consider firing only one Speedlite or using a self-timer to fire multiple units at different times.

Specifications

Type

Type	Shoe-mount E-TTL II/E-TTL autoflash Speedlite
Compatible cameras	EOS cameras with a multi-function shoe and firmware compatible with EL-5 * For details, refer to the Canon website (G).

Flash head

Light distribution		Unit	Flash coverage									
			14 mm ^{*1}	24 mm	28 mm	35 mm	50 mm	70 mm	80 mm	105 mm	135 mm	200 mm
Standard	m		14.8	28.7	30.0	36.0	42.7	47.1	49.1	53.9	55.4	60.0
	ft.		48.6	94.2	98.4	118.1	140.1	154.5	161.1	176.8	181.8	196.9
Guide number priority	m			36.0	36.0	42.7	49.1	53.9	55.4	60.0	60.0	60.0
	ft.			118.1	118.1	140.1	161.1	176.8	181.8	196.9	196.9	196.9
Even coverage	m			28.7	28.7	28.7	36.0	37.0	37.0	43.9	47.1	50.0
	ft.			94.2	94.2	94.2	118.1	121.4	121.4	144.0	154.5	164.0

* 1: When using the wide panel

Shutter speed		Unit	Flash coverage									
			14 mm ^{*1}	24 mm	28 mm	35 mm	50 mm	70 mm	80 mm	105 mm	135 mm	200 mm
1/125	m		8.4	16.4	17.1	20.5	24.4	26.9	28.0	30.8	31.6	34.2
	ft.		27.7	53.7	56.2	67.4	79.9	88.2	91.9	100.9	103.7	112.3
1/250	m		6.7	13.0	13.6	16.3	19.3	21.3	22.2	24.4	25.1	27.2
	ft.		22.0	42.7	44.6	53.5	63.5	70.0	73.0	80.1	82.4	89.2
1/500	m		4.7	9.2	9.6	11.5	13.7	15.1	15.7	17.3	17.7	19.2
	ft.		15.6	30.2	31.5	37.8	44.9	49.5	51.6	56.7	58.2	63.1
1/1000	m		3.4	6.5	6.8	8.2	9.7	10.7	11.1	12.2	12.6	13.6
	ft.		11.0	21.3	22.3	26.8	31.7	35.0	36.5	40.1	41.2	44.6
1/2000	m		2.4	4.6	4.8	5.8	6.8	7.5	7.9	8.6	8.9	9.6
	ft.		7.8	15.1	15.8	18.9	22.4	24.8	25.8	28.3	29.1	31.5
1/4000	m		1.7	3.3	3.4	4.1	4.8	5.3	5.6	6.1	6.3	6.8
	ft.		5.5	10.7	11.1	13.4	15.9	17.5	18.2	20.0	20.6	22.3
1/8000	m		1.2	2.3	2.4	2.9	3.4	3.8	3.9	4.3	4.4	4.8
	ft.		3.9	7.5	7.9	9.5	11.2	12.4	12.9	14.2	14.6	15.8

* 1: When using the wide panel

Guide number

Manual flash guide number

Maximum guide number (at approx. ISO 100)

Flash output	Unit	Flash coverage									
		14 mm ^{*1}	24 mm	28 mm	35 mm	50 mm	70 mm	80 mm	105 mm	135 mm	200 mm
1/1	m	14.8	28.7	30.0	36.0	42.7	47.1	49.1	53.9	55.4	60.0
	ft.	48.6	94.2	98.4	118.1	140.1	154.5	161.1	176.8	181.8	196.9
1/2	m	10.5	20.3	21.2	25.5	30.2	33.3	34.7	38.1	39.2	42.4
	ft.	34.4	66.6	69.6	83.7	99.1	109.3	113.8	125.0	128.6	139.1
1/4	m	7.4	14.4	15.0	18.0	21.4	23.6	24.6	27.0	27.7	30.0
	ft.	24.3	47.2	49.2	59.1	70.2	77.4	80.7	88.6	90.9	98.4
1/8	m	5.2	10.1	10.6	12.7	15.1	16.7	17.4	19.1	19.6	21.2
	ft.	17.1	33.1	34.8	41.7	49.5	54.8	57.1	62.7	64.3	69.6
1/16	m	3.7	7.2	7.5	9.0	10.7	11.8	12.3	13.5	13.9	15.0
	ft.	12.1	23.6	24.6	29.5	35.1	38.7	40.4	44.3	45.6	49.2
1/32	m	2.6	5.1	5.3	6.4	7.5	8.3	8.7	9.5	9.8	10.6
	ft.	8.5	16.7	17.4	21.0	24.6	27.2	28.5	31.2	32.2	34.8
1/64	m	1.9	3.6	3.8	4.5	5.3	5.9	6.1	6.7	6.9	7.5
	ft.	6.2	11.8	12.5	14.8	17.4	19.4	20.0	22.0	22.6	24.6
1/128	m	1.3	2.5	2.7	3.2	3.8	4.2	4.3	4.8	4.9	5.3
	ft.	4.3	8.2	8.9	10.5	12.5	13.8	14.1	15.7	16.1	17.4
1/256 ^{*2}	m	0.9	1.8	1.9	2.3	2.7	2.9	3.1	3.4	3.5	3.8
	ft.	3.0	5.9	6.2	7.5	8.9	9.5	10.2	11.2	11.5	12.5
1/512 ^{*2}	m	0.7	1.3	1.3	1.6	1.9	2.1	2.2	2.4	2.4	2.7
	ft.	2.3	4.3	4.3	5.2	6.2	6.9	7.2	7.9	7.9	8.9
1/1024 ^{*2}	m	0.5	0.9	0.9	1.1	1.3	1.5	1.5	1.7	1.7	1.9
	ft.	1.6	3.0	3.0	3.6	4.3	4.9	4.9	5.6	5.6	6.2

* 1: When using the wide panel

* 2: Not available with high-speed sync

Flash coverage
(focal length; for
35mm full-frame)

14 mm	Wide panel: Manual * Not compatible with EF15mm f/2.8 Fisheye or EF8-15mm f/4L Fisheye USM shooting angles of view
24 mm	
28 mm	Zoom
35 mm	
50 mm	• A: Auto Flash coverage is set automatically, accounting for [Auto zoom for sensor size] and [Light distribution] settings at the lens focal length
70 mm	
80 mm	• M: Manual Flash coverage is set manually * [Auto zoom for sensor size] and [Light distribution] settings are not taken into account
105 mm	
135 mm	
200 mm	

Bounce angle	Bounce direction		Bounce angle (approx.)					
	Up	0°	45°	60°	75°	90°	120°	
	Down		7°					
	Left	0°	60°	75°	90°	120°	150°	180°
	Right		60°	75°	90°	120°	150°	180°
Flash duration	Normal flash							
	Flash output	Flash duration (approx., sec.)		Flash output	Flash duration (approx., sec.)			
	1/1	1/710		1/64	1/18640			
	1/2	1/1310		1/128	1/23650			
	1/4	1/2610		1/256	1/29050			
	1/8	1/4890		1/512	1/35330			
	1/16	1/7990		1/1024	1/46290			
	1/32	1/13250						
Color temperature information transmission	Supported							

Exposure control

Flash modes (exposure control modes)	Flash modes and available functions				
	Flash mode	Flash exposure compensation	FEB	FE lock	Radio transmission wireless
	E-TTL II/E-TTL autoflash*1	○	○	○	○
	Manual flash				○
	Stroboscopic flash				○
	Group firing*2	○	○	○*3	○
Custom flash mode	Following the registered flash mode				
	* 1: Set automatically when the camera shooting mode is set to Basic Zone modes * 2: Can only be set when the Speedlite is used as a sender in radio transmission wireless operation * 3: Only groups set to E-TTL II/E-TTL autoflash				
Effective flash range	Dim interlocking range under the following conditions				
	<ul style="list-style-type: none"> • Sensor size: 35mm full-frame • Flash coverage: 50 mm • Aperture value: f/1.4 • ISO 100 • Light distribution: Standard 				
	Firing conditions	Effective flash range (approx.)			
	Normal flash (Flash-ready lamp: lit)	0.5–30.5 m / 1.6–100.1 ft.			
Quick flash (Flash-ready lamp: blinking)	0.5–18.6 m / 1.6–61.0 ft.				
High-speed sync (Shutter speed: 1/250 sec.)	0.5–13.7 m / 1.6–44.9 ft.				
Flash exposure compensation	±3 stops (in 1/3-stop or 1/2-stop increments) * Speedlite flash exposure compensation takes precedence if compensation is also set on the camera * Speedlite flash exposure compensation should be set to 0 to enable flash exposure compensation by the camera				
FEB	±3 stops (in 1/3-stop or 1/2-stop increments) * FEB auto cancel takes effect after three shots * Can be used with flash exposure compensation and FE lock				
FE lock	Supported				
FE memory	Supported				

Synchronization	Wireless	Flash mode	1st-curtain sync	2nd-curtain sync	High-speed sync
	OFF	E-TTL II/E-TTL autoflash	○	○	○
		Manual flash	○	○	○
		Stroboscopic flash	○		
	Radio transmission wireless (Sender)	E-TTL II/E-TTL autoflash	○	○	○
		Manual flash	○	○	○
		Stroboscopic flash	○		
Group firing		○	○	○	
Modeling lamp	Supported				
Modeling flash	Not supported * When mounted on a camera				

Flash recharge

Recharge time	Power supply	Recharge time (approx.)		
		Normal flash	Quick flash	
	Battery Pack LP-EL	0.1–1.2 sec.	0.1–1.0 sec.	
<p>* Using a new, fully charged Battery Pack LP-EL * Based on Canon testing standards</p>				
Flash-ready indication		Normal flash (fully charged)	Quick flash	Charging in progress
	Flash-ready lamp	Lit in red	Blinking in red (8 Hz)	Off
	LCD panel display	Not displayed	Not displayed	CHARGE Recharge level indicated in a range of 1–5
	Beep*1	Yes*2	Yes*3	—
<p>* 1: With Personal Function P.Fn-05 (Beep) set to ON * 2: With Personal Function P.Fn-01 (Quick flash) set to OFF * 3: With Personal Function P.Fn-01 (Quick flash) set to ON</p>				

AF-assist beam

LED mode	<p>The LED AF-assist beam is not used under these conditions</p> <ul style="list-style-type: none"> - Lens attached: Set to < MF > mode - Camera: Set to [Servo AF], [AF-assist beam firing] set to [Disable] <ul style="list-style-type: none"> • Light emitted Visible light (from white LEDs) • Compatible AF system Dual Pixel CMOS AF • Effective range <table border="1" data-bbox="270 336 933 390"> <thead> <tr> <th>AF points</th> <th>Effective range (approx.)</th> </tr> </thead> <tbody> <tr> <td>At center</td> <td>0.6–10 m / 2.0–32.8 ft.</td> </tr> </tbody> </table> <p>* Lens focal length: 24 mm or longer * Direction emitted: from the flash head at a 0° bounce angle</p>	AF points	Effective range (approx.)	At center	0.6–10 m / 2.0–32.8 ft.
AF points	Effective range (approx.)				
At center	0.6–10 m / 2.0–32.8 ft.				
Intermittent flash firing mode	<p>An intermittent AF-assist beam is not used under these conditions</p> <ul style="list-style-type: none"> - Lens attached: Set to < MF > mode - Camera: Set to [Servo AF], [AF-assist beam firing] set to [Disable] or [LED AF assist beam only] <ul style="list-style-type: none"> • Light emitted Visible light • Compatible AF system Dual Pixel CMOS AF • Effective range <table border="1" data-bbox="270 685 933 739"> <thead> <tr> <th>AF points</th> <th>Effective range (approx.)</th> </tr> </thead> <tbody> <tr> <td>At center</td> <td>0.6–10 m / 2.0–32.8 ft.</td> </tr> </tbody> </table> <p>* Lens focal length: 24 mm or longer * Direction emitted: from the flash head at a 0° bounce angle</p>	AF points	Effective range (approx.)	At center	0.6–10 m / 2.0–32.8 ft.
AF points	Effective range (approx.)				
At center	0.6–10 m / 2.0–32.8 ft.				

Wireless functions via radio transmission

Wireless settings	Sender	Supported * Secondary and additional units serve as sub-senders and display a "SUB SENDER" icon * Receivers cannot remotely control sub-senders
	Receiver	Supported
Communication functions	Standards compliance	IEEE 802.15.4, ARIB STD-T66
	Communication method	Primary modulation: OQPSK Secondary modulation: DS-SS
	Transmission frequency	2405–2475 MHz
	Channel	Channel 1–15 Setting: Auto / Manual
	Wireless radio ID	0000–9999 Setting: Manual
	Transmission range^{*1,2}	Approx. 30 m / 98.4 ft.
	Groups	Up to 5 groups (A/B/C/D/E) * Sender units are set to Group A
	Max. units for communication	Up to 16 senders and receivers, combined
	Max. sender units	Up to 15 * Secondary and additional units serve as sub-senders
	Max. receiver units	Up to 15
<p>* 1: Without any obstructions between senders and receivers, and without radio interference from other devices * 2: Transmission range may be shorter depending on factors such as how units are arranged, the surrounding environment, and weather conditions</p>		
Linked functions	<p>Supports linked shooting with automatic shutter release of up to 16 cameras (sender: 1; receivers: 15) linked to shutter release on the sender camera * Shooting is not simultaneous, because receiver cameras shoot slightly after the sender camera shutter release timing</p>	

Power source

Battery	Battery Pack LP-EL * AA/LR6 alkaline batteries and Ni-MH batteries cannot be used																					
Battery level indicator	Provided (5-level display)																					
External power source	Not supported																					
Maximum flash count	Approx. 350–2,450 * Using a new, fully charged Battery Pack LP-EL * Based on Canon testing standards																					
Radio transmission wireless shooting time	Approx. 17 hr. continuously * Time until the Speedlite turns off while connected wirelessly via radio transmission * With sender flash firing disabled, and using a new, fully charged Battery Pack LP-EL																					
Auto power off	<p>Time from when a connected camera turns off or auto power off is activated until the Speedlite turns off</p> <p>* Since the Speedlite can detect the state of the connection with the camera, while the camera is on, it does not enter auto power off alone (unintentionally).</p> <table border="1"> <thead> <tr> <th>Status</th> <th>Custom Function</th> <th>Time</th> </tr> </thead> <tbody> <tr> <td>During normal operation</td> <td>C.Fn-01-0</td> <td>Approx. 90 sec.</td> </tr> <tr> <td>When set as a sender in radio transmission wireless operation</td> <td>C.Fn-01-0</td> <td rowspan="2">Approx. 5 min.</td> </tr> <tr> <td>During linked shooting</td> <td>C.Fn-01-0</td> </tr> <tr> <td rowspan="2">When set as a receiver in radio transmission wireless operation</td> <td>C.Fn-10-0</td> <td>Approx. 1 hr.</td> </tr> <tr> <td>C.Fn-10-1</td> <td>Approx. 10 min.</td> </tr> <tr> <td rowspan="2">Standby before power ON after auto power off when set as a receiver</td> <td>C.Fn-11-0</td> <td>Approx. 8 hr.</td> </tr> <tr> <td>C.Fn-11-1</td> <td>Approx. 1 hr.</td> </tr> </tbody> </table> <p>Reactivated in response to the following operations</p> <ul style="list-style-type: none"> Pressing the camera shutter button halfway Pressing the test flash button Using <  > menu direct functionality with EL-5 attached to a camera 	Status	Custom Function	Time	During normal operation	C.Fn-01-0	Approx. 90 sec.	When set as a sender in radio transmission wireless operation	C.Fn-01-0	Approx. 5 min.	During linked shooting	C.Fn-01-0	When set as a receiver in radio transmission wireless operation	C.Fn-10-0	Approx. 1 hr.	C.Fn-10-1	Approx. 10 min.	Standby before power ON after auto power off when set as a receiver	C.Fn-11-0	Approx. 8 hr.	C.Fn-11-1	Approx. 1 hr.
Status	Custom Function	Time																				
During normal operation	C.Fn-01-0	Approx. 90 sec.																				
When set as a sender in radio transmission wireless operation	C.Fn-01-0	Approx. 5 min.																				
During linked shooting	C.Fn-01-0																					
When set as a receiver in radio transmission wireless operation	C.Fn-10-0	Approx. 1 hr.																				
	C.Fn-10-1	Approx. 10 min.																				
Standby before power ON after auto power off when set as a receiver	C.Fn-11-0	Approx. 8 hr.																				
	C.Fn-11-1	Approx. 1 hr.																				

Dimensions / weight

Dimensions	Product	W × H × D
	Body	Approx. 80.2×139.9×123.3 mm / 3.16×5.51×4.85 in.
Weight	Product	Weight
	Body only	Approx. 491 g / 17.32 oz.
	Body and battery (Battery Pack LP-EL)	Approx. 606 g / 21.38 oz.

Operation environment

Working temperature range	0–45°C / 32–113°F
Working humidity	85 % or less

- All specifications above are based on Canon's testing standards.
- Product specifications and external appearance are subject to change without notice.

Accessories

Use of genuine Canon accessories is recommended

Because this product is designed for optimal performance with genuine Canon accessories, use with genuine accessories is recommended.

Note that Canon shall not be liable for any damages resulting from accidents, such as malfunction or fire, that occur due to battery leakage or explosion or other problems from non-genuine Canon accessories. Please note that any repair of Canon products that is required as a result is not covered under warranty but may be available for a fee.

Caution

- Battery Pack LP-EL is designed for use only with genuine Canon products. Use with non-designated battery chargers or other products can in no way be guaranteed by Canon to be free of malfunction or accidents.